



**THE DATASHEET OF
ATB322524-0110-T000**



Step-up transformers
Wound SMD
ATB series



ATB3225 type



FEATURES

- Compact step-up transformer developed for Xenon circuits.
- ATB3225 is smaller than conventional step-up transformers, which makes it possible to minimize the mounting area.
- Auto winding allows for stable winding so that stable charging characteristics can be acquired.
- Automated processing results in highly reliable products.
- Operating temperature range: -40 to +85°C (including self-temperature rise)

APPLICATION

- Xenon Flash, HAPTICS

PART NUMBER CONSTRUCTION

ATB	322515	-	0110	-	T	000
Series name	LxWxT dimensions 3.2x2.5x1.5 mm 3.2x2.5x2.4 mm		Turn ratio		Packaging style	Internal code

CHARACTERISTICS SPECIFICATION TABLE

Turn ratio	Inductance (μH)[at100kHz]	DC resistance (Ω)		Leakage inductance (μH)[at100kHz]	Withstanding voltage	Rated current	Part No.
		Primary	Secondary				
1:10	7.0 \pm 20%	0.5max.	60max.	0.4max.	500V rms	0.6A rms	ATB322515-0110-T000
1:10.2	7.0 \pm 20%	0.5max.	60max.	0.4max.	500V rms	0.7A rms	ATB322524-0110-T000

Measurement equipment

Measurement item	Product No.	Manufacturer
Inductance	4284A	Keysight Technologies
DC resistance	4338A	Keysight Technologies
Leakage inductance	4284A	Keysight Technologies
Withstanding voltage	4339A	Keysight Technologies

* Equivalent measurement equipment may be used.

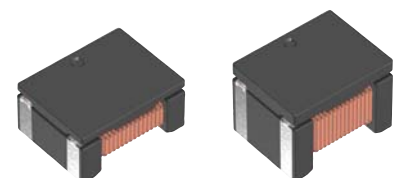

ATB3225 type

INDUCTANCE VS. DC BIAS CHARACTERISTICS

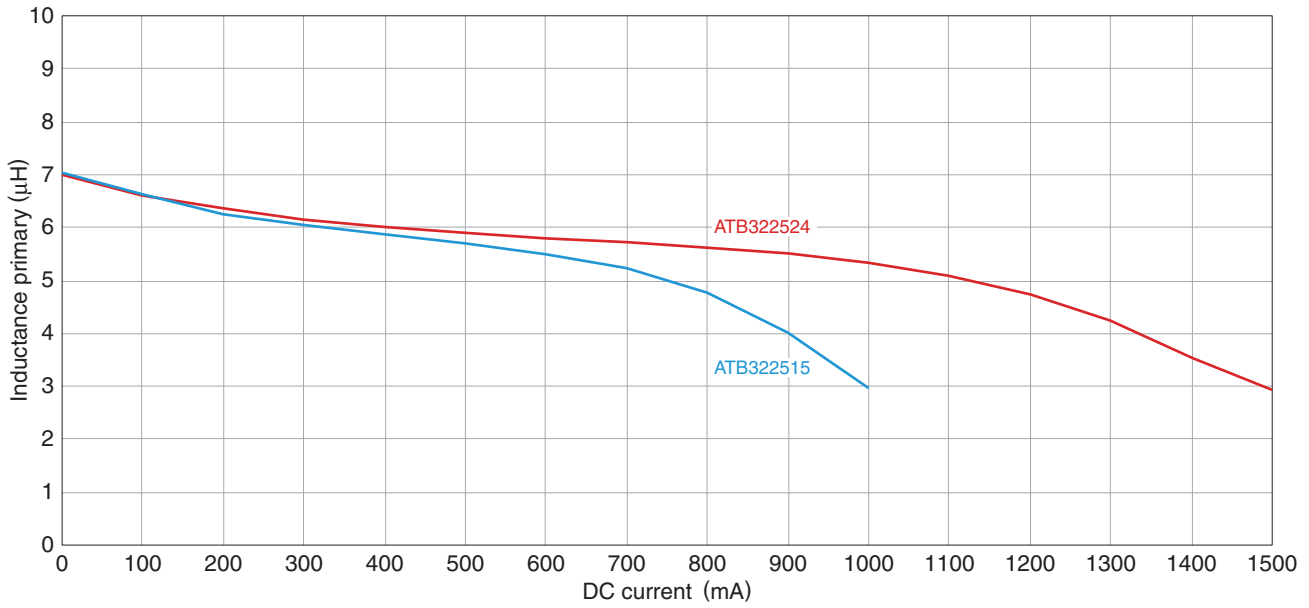

Measurement equipment

Product No.	Manufacturer
4284A	Keysight Technologies

* Equivalent measurement equipment may be used.

ATB3225 type

SHAPE & DIMENSIONS

ATB322515

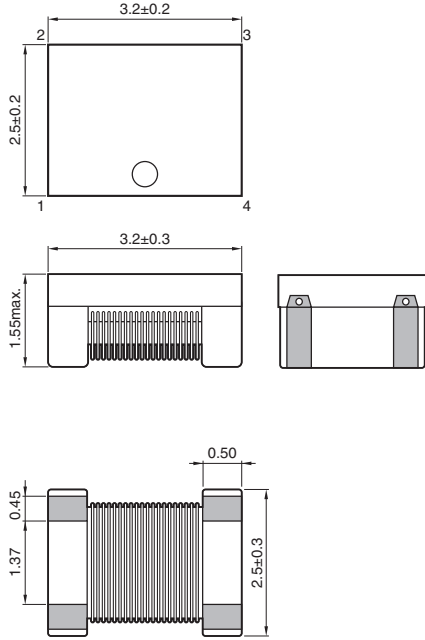

ATB322524

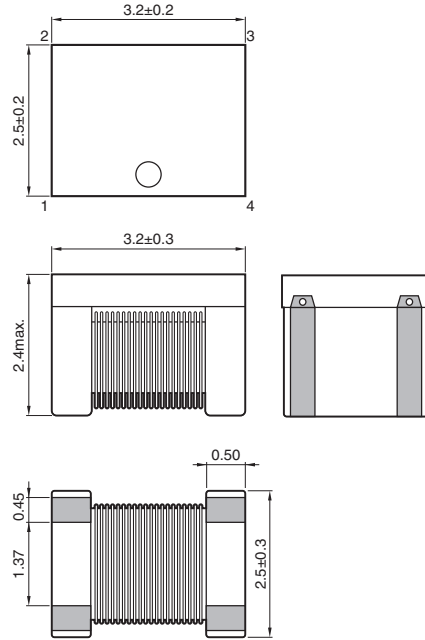

Dimensions in mm

RECOMMENDED LAND PATTERN

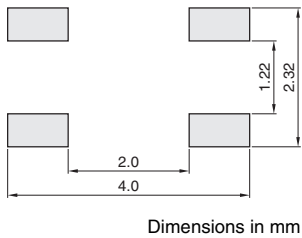

Dimensions in mm

CIRCUIT DIAGRAM



RECOMMENDED REFLOW PROFILE

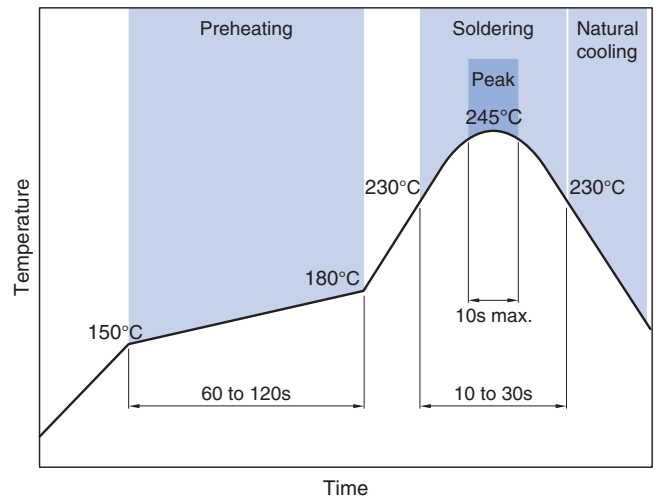

⚠ Please be sure to request delivery specifications that provide further details on the features and specifications of the products for proper and safe use. (3/5)
Please note that the contents may change without any prior notice due to reasons such as upgrading.

ATB3225 type

PACKAGING STYLE

REEL DIMENSIONS

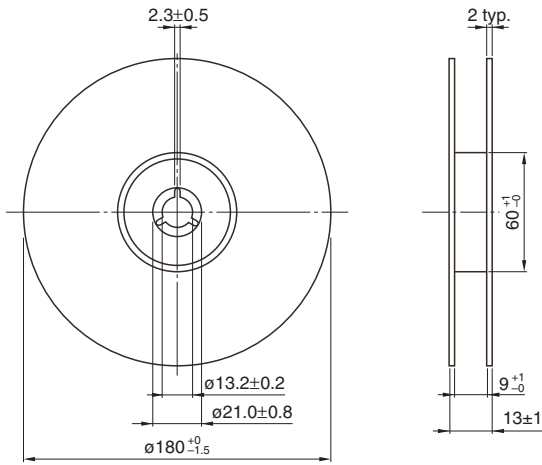

Dimensions in mm

TAPE DIMENSIONS

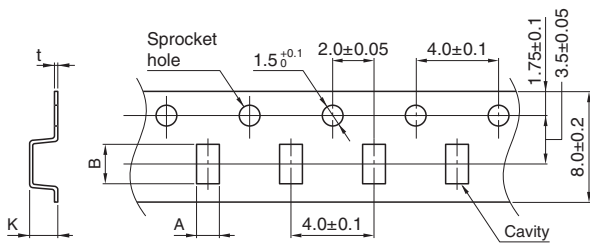

Dimensions in mm

Type	A	B	K
ATB322515	2.9±0.1	3.6±0.1	1.6±0.05
ATB322524	2.9±0.1	3.6±0.1	2.5±0.05

PACKAGE QUANTITY

Package quantity	1,000 pcs/reel
------------------	----------------

TEMPERATURE RANGE, INDIVIDUAL WEIGHT

Type	Operating temperature range*	Storage temperature range**	Individual weight
ATB322515	-40 to +85°C	-40 to +85°C	50 mg
ATB322524	-40 to +85°C	-40 to +85°C	80 mg

* Operating temperature range includes self-temperature rise.

** The storage temperature range is for after the assembly.

REMINDERS FOR USING THESE PRODUCTS

Before using these products, be sure to request the delivery specifications.

SAFETY REMINDERS

Please pay sufficient attention to the warnings for safe designing when using this products.

REMINDERS

- The storage period is within 6 months. Be sure to follow the storage conditions (temperature: 5 to 40°C, humidity: 10 to 75% RH or less).
If the storage period elapses, the soldering of the terminal electrodes may deteriorate.
- Do not use or store in locations where there are conditions such as gas corrosion (salt, acid, alkali, etc.).
- Before soldering, be sure to preheat components.
The preheating temperature should be set so that the temperature difference between the solder temperature and chip temperature does not exceed 150°C.
- Soldering corrections after mounting should be within the range of the conditions determined in the specifications.
If overheated, a short circuit, performance deterioration, or lifespan shortening may occur.
- When embedding a printed circuit board where a chip is mounted to a set, be sure that residual stress is not given to the chip due to the overall distortion of the printed circuit board and partial distortion such as at screw tightening portions.
- Self heating (temperature increase) occurs when the power is turned ON, so the tolerance should be sufficient for the set thermal design.
- Carefully lay out the coil for the circuit board design of the non-magnetic shield type.
A malfunction may occur due to magnetic interference.
- Use a wrist band to discharge static electricity in your body through the grounding wire.
- Do not expose the products to magnets or magnetic fields.
- Do not use for a purpose outside of the contents regulated in the delivery specifications.
- The products listed on this catalog are intended for use in general electronic equipment (AV equipment, telecommunications equipment, home appliances, amusement equipment, computer equipment, personal equipment, office equipment, measurement equipment, industrial robots) under a normal operation and use condition.
The products are not designed or warranted to meet the requirements of the applications listed below, whose performance and/or quality require a more stringent level of safety or reliability, or whose failure, malfunction or trouble could cause serious damage to society, person or property.
If you intend to use the products in the applications listed below or if you have special requirements exceeding the range or conditions set forth in the each catalog, please contact us.

- (1) Aerospace/aviation equipment
- (2) Transportation equipment (cars, electric trains, ships, etc.)
- (3) Medical equipment
- (4) Power-generation control equipment
- (5) Atomic energy-related equipment
- (6) Seabed equipment
- (7) Transportation control equipment

- (8) Public information-processing equipment
- (9) Military equipment
- (10) Electric heating apparatus, burning equipment
- (11) Disaster prevention/crime prevention equipment
- (12) Safety equipment
- (13) Other applications that are not considered general-purpose applications

When designing your equipment even for general-purpose applications, you are kindly requested to take into consideration securing protection circuit/device or providing backup circuits in your equipment.

Looking for pricing, stock, or lifecycle information?

Click below to explore more details on WIN SOURCE:

 [View ATB322524-0110-T000](#) on WIN SOURCE

 [TDK Corporation](#) Information

Optimize Your Supply Chain with WIN SOURCE Solutions

-  Global Sourcing Solution
-  Obsolete Management
-  Cost Control Management
-  Shortage Management
-  Alternative Solution
-  Excess Inventory Management