



**HIGH-FREQUENCY HIGH-SIDE AND LOW-SIDE GATE DRIVER IN V-DFN3030-10**
**Description**

The DGD05473 is a high-frequency gate driver capable of driving n-channel MOSFETs. The floating high-side driver is rated up to 50V.

The DGD05473 logic inputs are compatible with standard TTL and CMOS levels (down to 3.3V) to interface easily with MCUs. UVLO for high-side and low-side will protect a MOSFET with loss of supply. To protect MOSFETs, cross conduction prevention logic prevents the HO and LO outputs from being on at the same time.

Fast and well-matched propagation delays allow a higher switching frequency, enabling a smaller, more compact power switching design, using smaller associated components. To minimize space, an internal bootstrap diode is included. The DGD05473 is offered in the V-DFN3030-10 (Standard) package and operates over an extended -40°C to +125°C temperature range.

**Features**

- 50V Floating High-Side Driver
- Drives Two N-Channel MOSFETs in a Half-Bridge Configuration
- 1.5A Source / 2.5A Sink Output Current Capability
- Internal Bootstrap Diode Included
- Undervoltage Lockout for High-Side and Low-Side Drivers
- Delay Matching Maximum of 5ns
- Propagation Delay Typical of 20ns
- Logic Input (HIN, LIN, and EN) 3.3V Capability
- Ultra-Low Standby Currents (< 1µA)
- Extended Temperature Range: -40°C to +125°C
- **Totally Lead-Free & Fully RoHS Compliant (Notes 1 & 2)**
- **Halogen and Antimony Free. "Green" Device (Note 3)**
- **For automotive applications requiring specific change control (i.e. parts qualified to AEC-Q100/101/104/200, PPAP capable, and manufactured in IATF 16949 certified facilities), please [contact us](#) or your local Diodes representative. <https://www.diodes.com/quality/product-definitions/>**

**Applications**

- DC-DC converters
- Motor controls
- Battery-powered hand tools
- eCig devices
- Class-D power amplifiers

**Mechanical Data**

- Package: V-DFN3030-10
- Package Material: Molded Plastic. "Green" Molding Compound. UL Flammability Classification Rating 94V-0
- Moisture Sensitivity: Level 3 per J-STD-020
- Terminals: Finish – Matte Tin Finish. Solderable per MIL-STD-202, Method 208 (E3)
- Weight: 0.017 grams (Approximate)

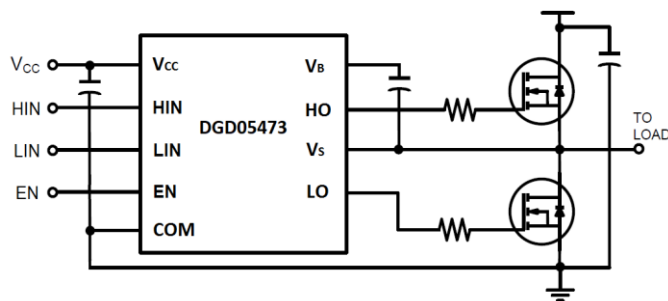

Typical Configuration

V-DFN3030-10 (Standard)



Top View

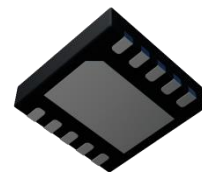

Bottom View

**Ordering Information** (Note 4)

Part Number	Package	Marking	Reel Size (inches)	Tape Width (mm)	Packing	
					Qty.	Carrier
DGD05473FN-7	V-DFN3030-10 (Standard)	DGD05473	7	8	3,000	Reel

- Notes:
1. No purposely added lead. Fully EU Directive 2002/95/EC (RoHS), 2011/65/EU (RoHS 2) & 2015/863/EU (RoHS 3) compliant.
  2. See <https://www.diodes.com/quality/lead-free/> for more information about Diodes Incorporated's definitions of Halogen- and Antimony-free, "Green" and Lead-free.
  3. Halogen- and Antimony-free "Green" products are defined as those which contain <900ppm bromine, <900ppm chlorine (<1500ppm total Br + Cl) and <1000ppm antimony compounds.
  4. For packaging details, go to our website at <https://www.diodes.com/design/support/packaging/diodes-packaging/>.

## Marking Information



DGD05473 = Product Type Marking Code  
YY = Year (ex: 24 = 2024)  
WW = Week (01 to 53)

## Pin Assignments

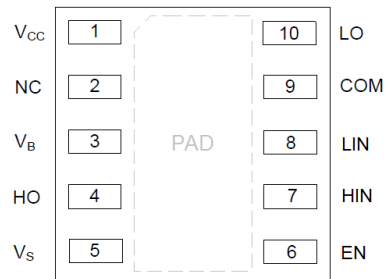

Top View: V-DFN3030-10 (Standard)

## Pin Descriptions

Pin Number	Pin Name	Function
1	V <sub>CC</sub>	Low-Side and Logic Supply
2	NC	No Connect (No Internal Connection)
3	V <sub>B</sub>	High-Side Floating Supply
4	HO	High-Side Gate Drive Output
5	V <sub>S</sub>	High-Side Floating Supply Return
6	EN	Logic Input Enable, a Logic Low turns off Gate Driver
7	HIN	Logic Input for High-Side Gate Driver, in Phase with HO
8	LIN	Logic Input for Low-Side Gate Driver, in Phase with LO
9	COM	Low-Side and Logic Return
10	LO	Low-Side Gate Drive Output
PAD	Substrate	Connect to COM on PCB

**Functional Block Diagram**

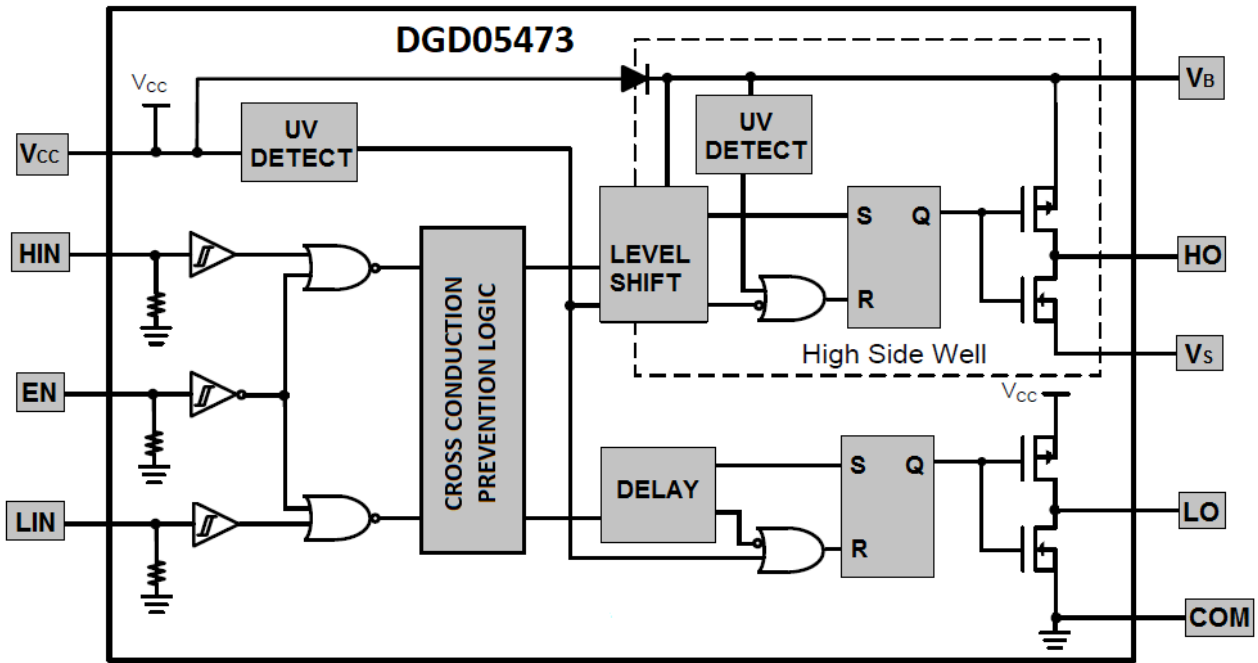

**Absolute Maximum Ratings** (@  $T_A = +25^\circ\text{C}$ , unless otherwise specified.)

Characteristic	Symbol	Value	Unit
High-Side Floating Positive Supply Voltage	$V_B$	-0.3 to +60	V
High-Side Floating Negative Supply Voltage	$V_S$	$V_B - 14$ to $V_B + 0.3$	V
High-Side Floating Output Voltage	$V_{HO}$	$V_S - 0.3$ to $V_B + 0.3$	V
Offset Supply Voltage Transient	$dV_S / dt$	50	V/ns
Logic and Low-Side Fixed Supply Voltage	$V_{CC}$	-0.3 to +14	V
Low-Side Output Voltage	$V_{LO}$	-0.3 to $V_{CC} + 0.3$	V
Logic-Input Voltage (HIN, LIN and EN)	$V_{IN}$	-0.3 to $V_{CC} + 0.3$	V
Bootstrap Diode Current (Pulsed < 10 $\mu$ s)	$I_{BD}$	1	A

**Thermal Characteristics** (@  $T_A = +25^\circ\text{C}$ , unless otherwise specified.)

Characteristic	Symbol	Value	Unit
Power Dissipation Linear Derating Factor (Note 5)	$P_D$	0.4	W
Thermal Resistance, Junction to Ambient (Note 5)	$R_{\theta JA}$	64	$^\circ\text{C}/\text{W}$
Thermal Resistance, Junction to Case (Note 5)	$R_{\theta JC}$	42	$^\circ\text{C}/\text{W}$
Operating Temperature	$T_J$	+150	$^\circ\text{C}$
Lead Temperature (Soldering, 10s)	$T_L$	+300	
Storage Temperature Range	$T_{STG}$	-55 to +150	

Note: 5. When mounted on a standard JEDEC 2-layer FR-4 board.

**Recommended Operating Conditions**

Parameter	Symbol	Min	Max	Unit
High-Side Floating Supply	$V_B$	$V_S + 4.2$	$V_S + 14$	V
High-Side Floating Supply Offset Voltage	$V_S$	(Note 6)	50 (Note 7)	V
High-Side Floating Output Voltage	$V_{HO}$	$V_S$	$V_B$	V
Logic and Low-Side Fixed Supply Voltage	$V_{CC}$	4.5 (Note 8)	14	V
Low-Side Output Voltage	$V_{LO}$	0	$V_{CC}$	V
Logic-Input Voltage (HIN, LIN and EN)	$V_{IN}$	0	5	V
Ambient Temperature	$T_A$	-40	+125	$^\circ\text{C}$

Notes: 6. Logic operation for  $V_S$  of -5V to +50V.

7. Provided  $V_B$  does not exceed absolute maximum rating of 60V.

8. For operation of  $V_{CC} = 4.5\text{V}$  to  $4.9\text{V}$ , an external bootstrap Schottky diode (0.3V Vf<sub>d</sub>, 1A) is necessary, see Figure 4. For operation  $V_{CC} \geq 4.9\text{V}$ , the external Schottky diode is not required.

**DC Electrical Characteristics** ( $V_{CC} = V_{BS} = 12V$ ,  $COM = V_S = 0V$ , @  $T_A = +25^\circ C$ , unless otherwise specified.) (Note 9)

Parameter	Symbol	Min	Typ	Max	Unit	Conditions
Logic "1" Input Voltage	$V_{IH}$	2.4	—	—	V	—
Logic "0" Input Voltage	$V_{IL}$	—	—	0.8	V	—
Enable Logic "1" Input Voltage	$V_{ENIH}$	1.6	—	—	V	—
Enable Logic "0" Input Voltage	$V_{ENIL}$	—	—	0.7	V	—
Input Voltage Hysteresis	$V_{INHYS}$	—	0.6	—	V	—
Enable Input Voltage Hysteresis	$V_{ENINHYS}$	—	0.1	—	V	—
High-Level Output Voltage, $V_{BIAS} - V_O$	$V_{OH}$	—	0.45	0.6	V	$I_{O+} = 100mA$
Low-Level Output Voltage, $V_O$	$V_{OL}$	—	0.15	0.22	V	$I_{O-} = 100mA$
Offset Supply Leakage Current	$I_{LK}$	—	1	5	$\mu A$	$V_B = V_S = 60V$
$V_{CC}$ Shutdown Supply Current	$I_{CCSD}$	—	0	1	$\mu A$	$V_{IN} = 0V$ or $5V$ , $V_{EN} = 0V$
$V_{CC}$ Quiescent Supply Current	$I_{CCQ}$	—	130	200	$\mu A$	$V_{IN} = 0V$ or $5V$
$V_{CC}$ Operating Supply Current	$I_{CCOP}$	—	7.3	—	mA	$f_s = 500kHz$ , $C_L = 1000pF$
$V_{BS}$ Quiescent Supply Current	$I_{BSQ}$	—	40	100	$\mu A$	$V_{IN} = 0V$ or $5V$
$V_{BS}$ Operating Supply Current	$I_{BSOP}$	—	7.3	—	mA	$f_s = 500kHz$ , $C_L = 1000pF$
Logic "1" Input Bias Current	$I_{IN+}$	—	—	50	$\mu A$	$V_{IN} = 5V$
Logic "0" Input Bias Current	$I_{IN-}$	—	—	5	$\mu A$	$V_{IN} = 0V$
Enable Logic "1" Input Bias Current	$I_{ENIN+}$	—	43	60	$\mu A$	$V_{IN} = 5V$
Enable Logic "0" Input Bias Current	$I_{ENIN-}$	—	0	5	$\mu A$	$V_{IN} = 0V$
$V_{BS}$ Supply Undervoltage Positive Going Threshold	$V_{BSUV+}$	3.3	3.8	4.4	V	—
$V_{BS}$ Supply Undervoltage Negative Going Threshold	$V_{BSUV-}$	2.9	3.3	3.9	V	—
$V_{CC}$ Supply Undervoltage Positive Going Threshold	$V_{CCUV+}$	3.3	3.8	4.4	V	—
$V_{CC}$ Supply Undervoltage Negative Going Threshold	$V_{CCUV-}$	2.9	3.3	3.9	V	—
Output High Short-Circuit Pulsed Current	$I_{O+}$	1.0	1.5	—	A	$V_O = 0V$ , $P_w \leq 10\mu s$
Output Low Short-Circuit Pulsed Current	$I_{O-}$	1.9	2.5	—	A	$V_O = 15V$ , $P_w \leq 10\mu s$
Forward Voltage of Bootstrap Diode	$V_{F1}$	—	0.67	—	V	$I_F = 100\mu A$
Forward Voltage of Bootstrap Diode	$V_{F2}$	—	1.2	—	V	$I_F = 100mA$

Note: 9. The  $V_{IN}$  and  $I_{IN}$  parameters are applicable to the logic pins: HIN, LIN and EN. The  $V_O$  and  $I_O$  parameters are applicable to the respective output pins: HO and LO.

**AC Electrical Characteristics** ( $V_{CC} = V_{BS} = 12V$ ,  $COM = V_S = 0V$ ,  $C_L = 1000pF$ , @  $T_A = +25^\circ C$ , unless otherwise specified.)

Parameter	Symbol	Min	Typ	Max	Unit	Conditions
Turn-On Propagation Delay	$t_{on}$	—	20	35	ns	—
Turn-Off Propagation Delay	$t_{off}$	—	23	56	ns	$V_S = 50V$
Delay Matching, HO & LO Turn-On	$t_{DM}$	—	—	5	ns	—
Turn-On Rise Time	$t_r$	—	16	30	ns	—
Turn-Off Fall Time	$t_f$	—	12	25	ns	—

**Timing Waveforms**

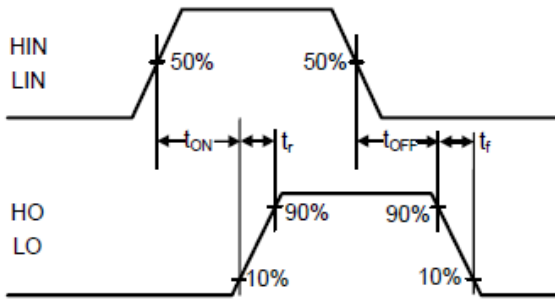

**Figure 1.** Switching Time Waveform Definitions

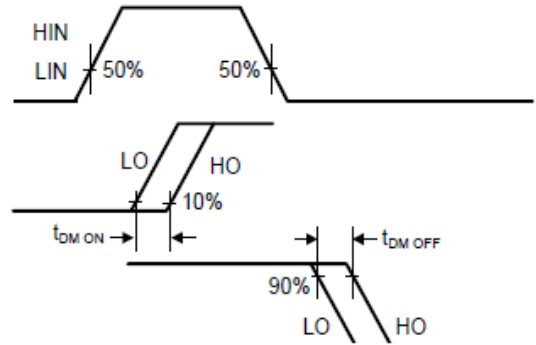

**Figure 2.** Delay Matching Waveform Definitions

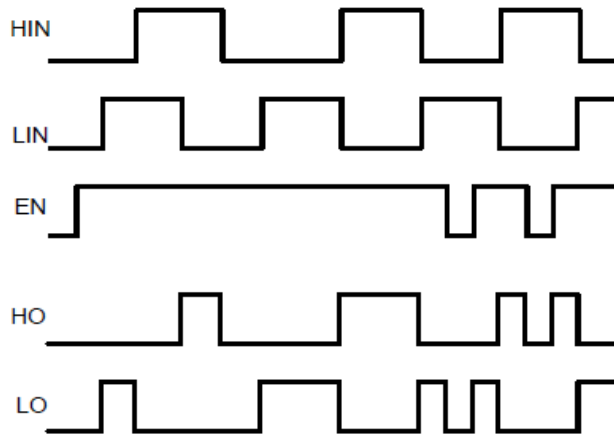

**Figure 3.** Input / Output Timing Diagram

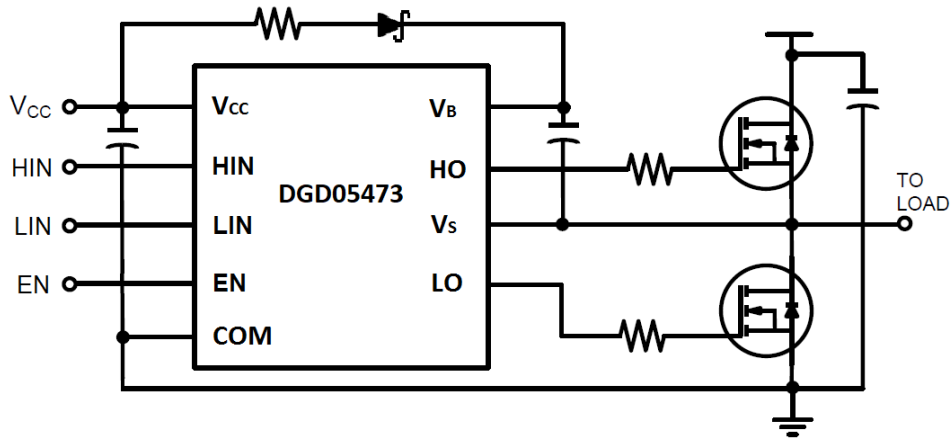

**Figure 4.** Typical application necessary for  $V_{CC} = 4.5V$  to  $4.9V$  operation. For  $V_{CC} \geq 4.9V$ , the bootstrap Schottky diode (0.3V Voltage drop, 1A) and resistor are not required.

**Typical Performance Characteristics** ( $V_{CC} = 12V$ , @  $T_A = +25^\circ C$ , unless otherwise specified.)

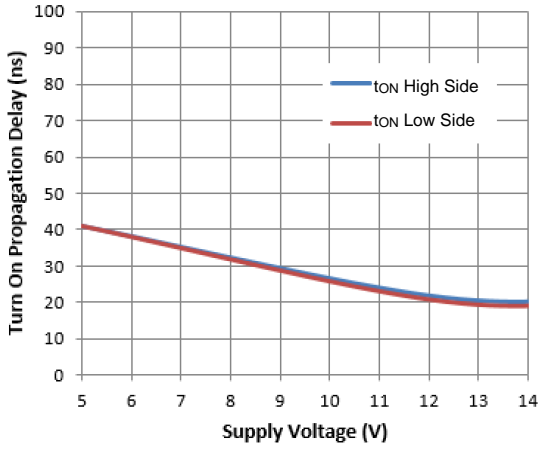

Figure 5. Turn-on Propagation Delay vs. Supply Voltage

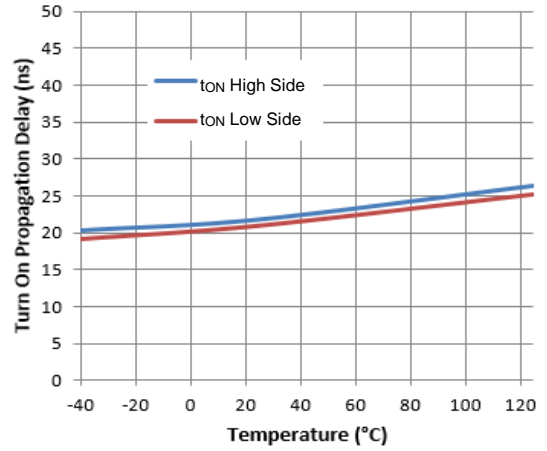

Figure 6. Turn-on Propagation Delay vs. Temperature

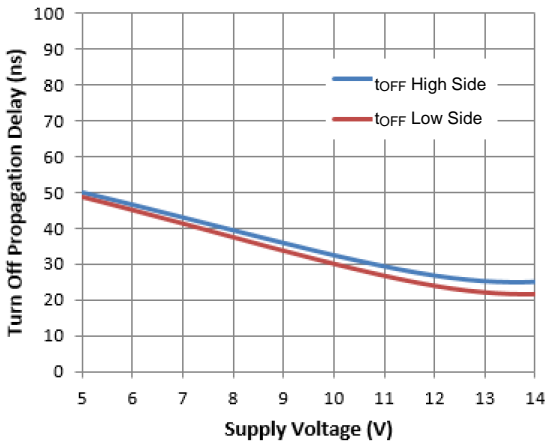

Figure 7. Turn-off Propagation Delay vs. Supply Voltage

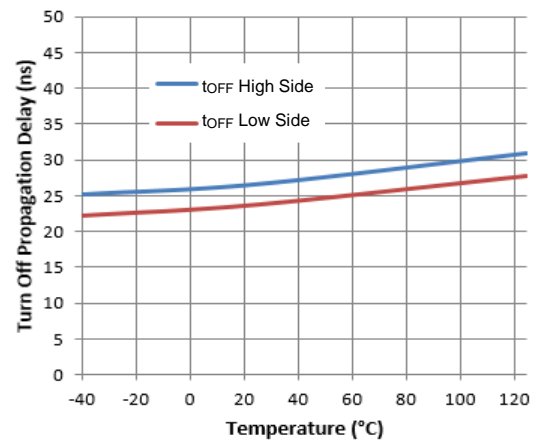

Figure 8. Turn-off Propagation Delay vs. Temperature

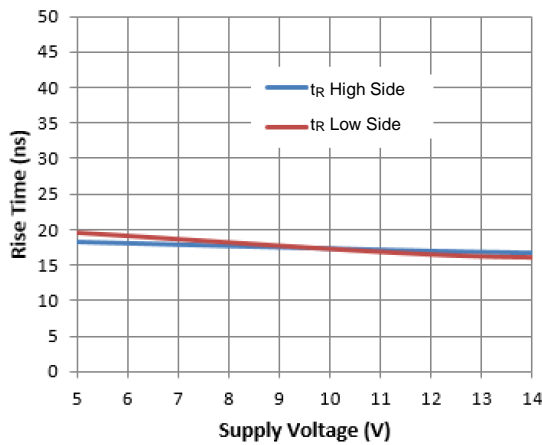

Figure 9. Rise Time vs. Supply Voltage

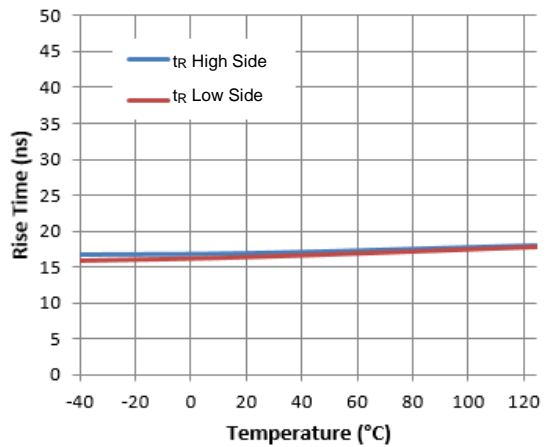

Figure 10. Rise Time vs. Temperature

**Typical Performance Characteristics** ( $V_{CC} = 12V$ , @  $T_A = +25^\circ C$ , unless otherwise specified.) (continued)

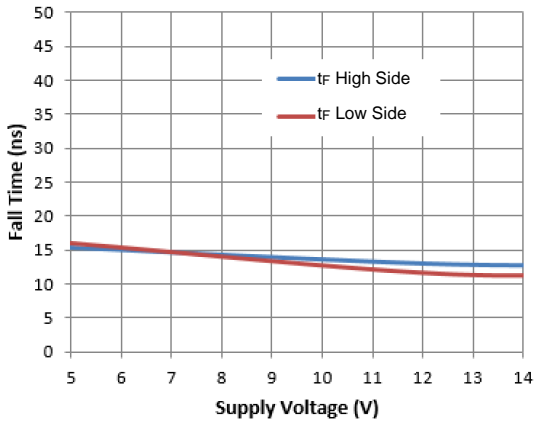

Figure 11. Fall Time vs. Supply Voltage

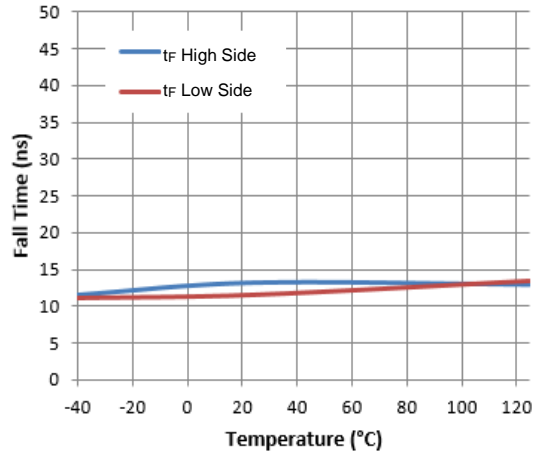

Figure 12. Fall Time vs. Temperature

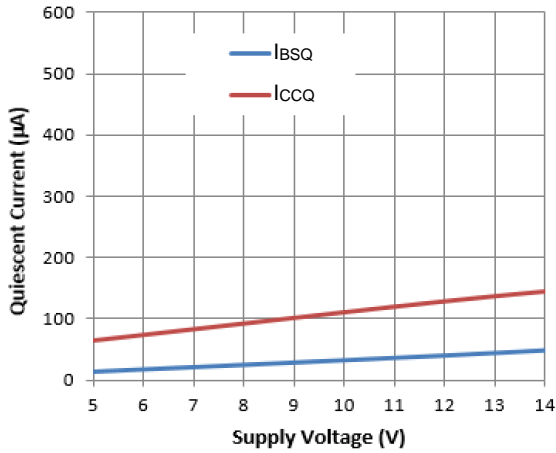

Figure 13. Quiescent Current vs. Supply Voltage

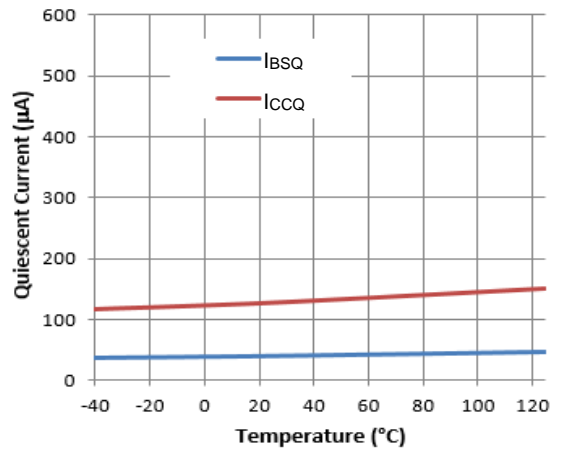

Figure 14. Quiescent Current vs. Temperature

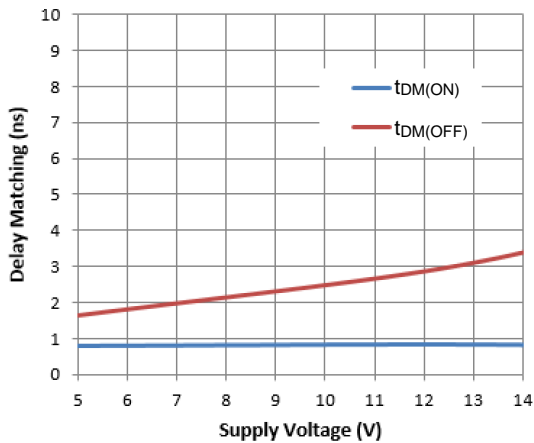

Figure 15. Delay Matching vs. Supply Voltage

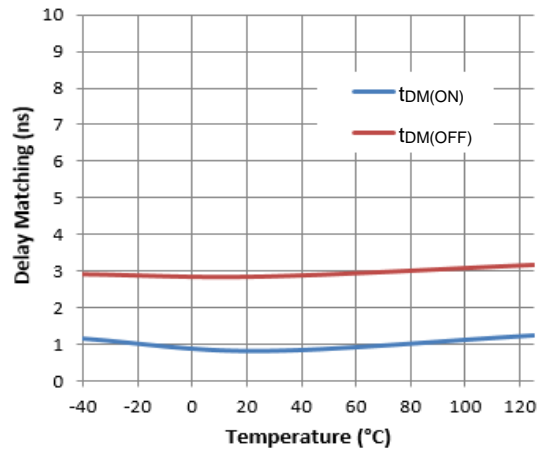

Figure 16. Delay Matching vs. Temperature

**Typical Performance Characteristics** ( $V_{CC} = 12V$ , @  $T_A = +25^\circ C$ , unless otherwise specified.) (continued)

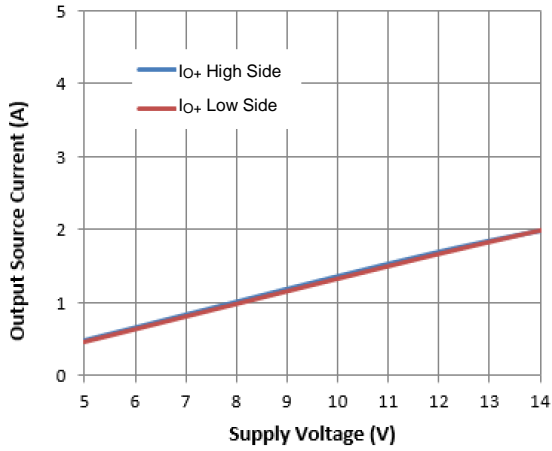

Figure 17. Output Source Current vs. Supply Voltage

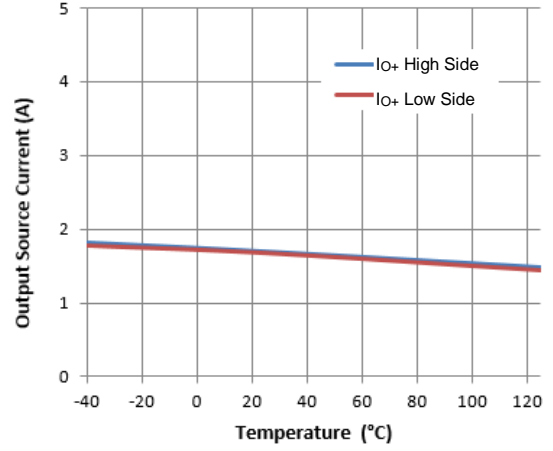

Figure 18. Output Source Current vs. Temperature

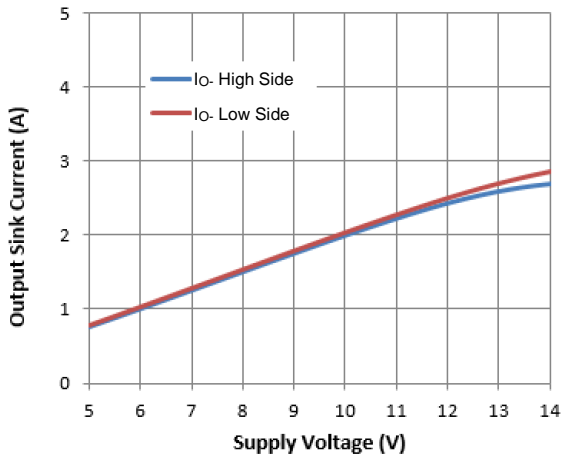

Figure 19. Output Sink Current vs. Supply Voltage

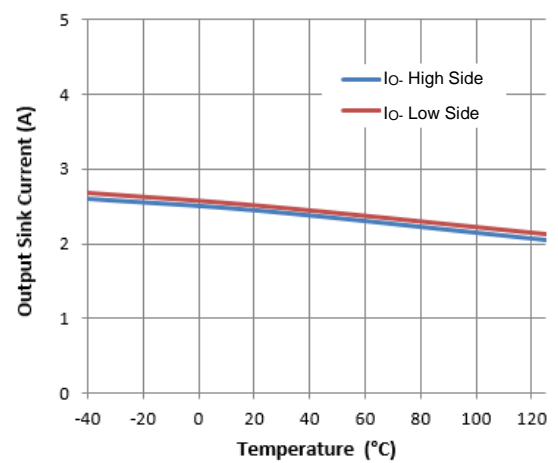

Figure 20. Output Sink Current vs. Temperature

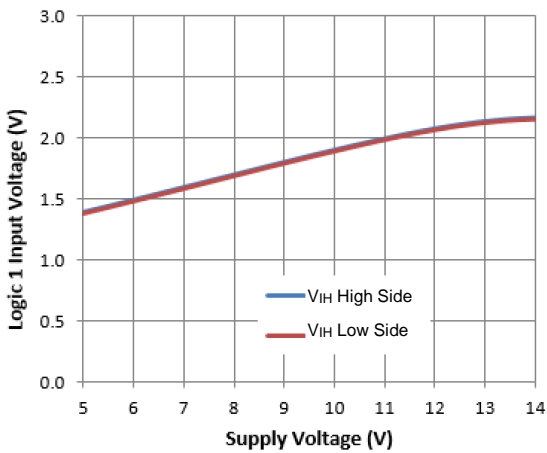

Figure 21. Logic 1 Input Voltage vs. Supply Voltage

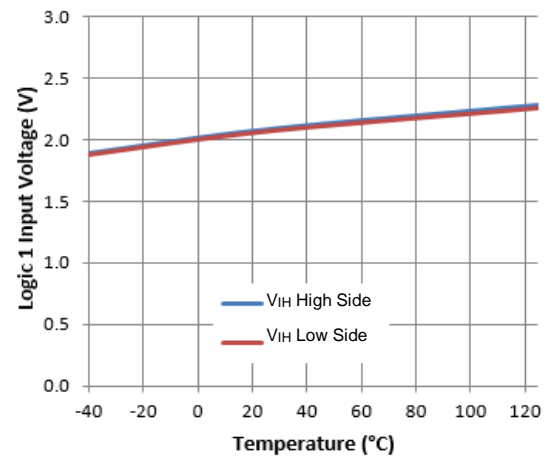

Figure 22. Logic 1 Input Voltage vs. Temperature

**Typical Performance Characteristics** ( $V_{CC} = 12V$ , @  $T_A = +25^\circ C$ , unless otherwise specified.) (continued)

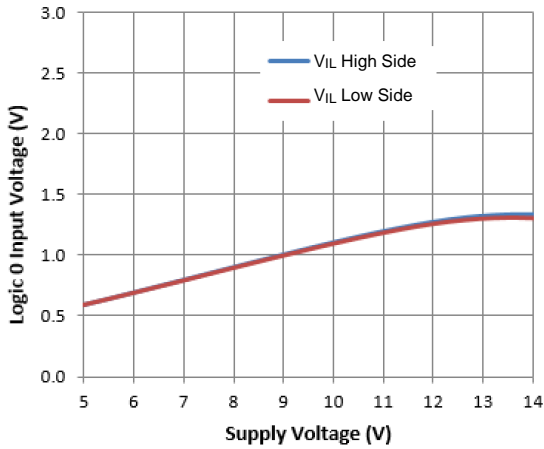

Figure 23. Logic 0 Input Voltage vs. Supply Voltage

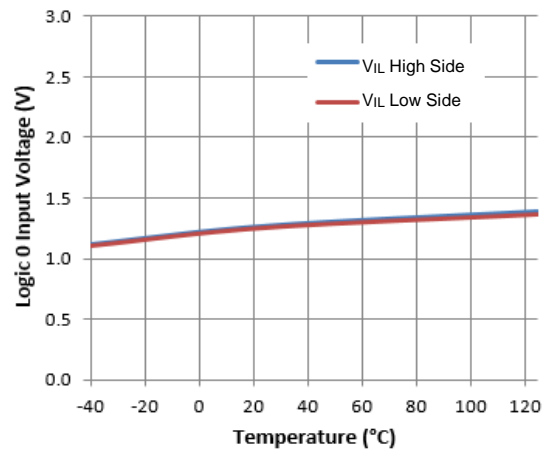

Figure 24. Logic 0 Input Voltage vs. Temperature

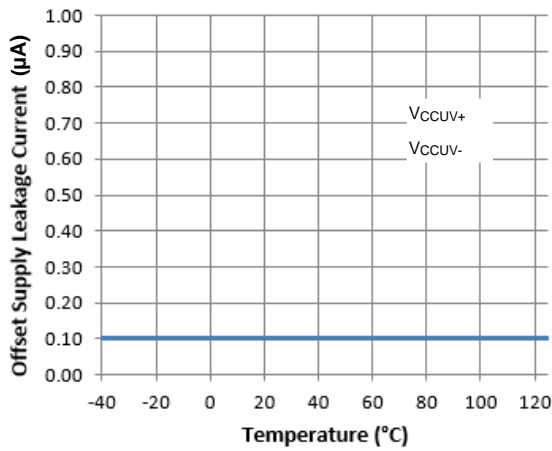
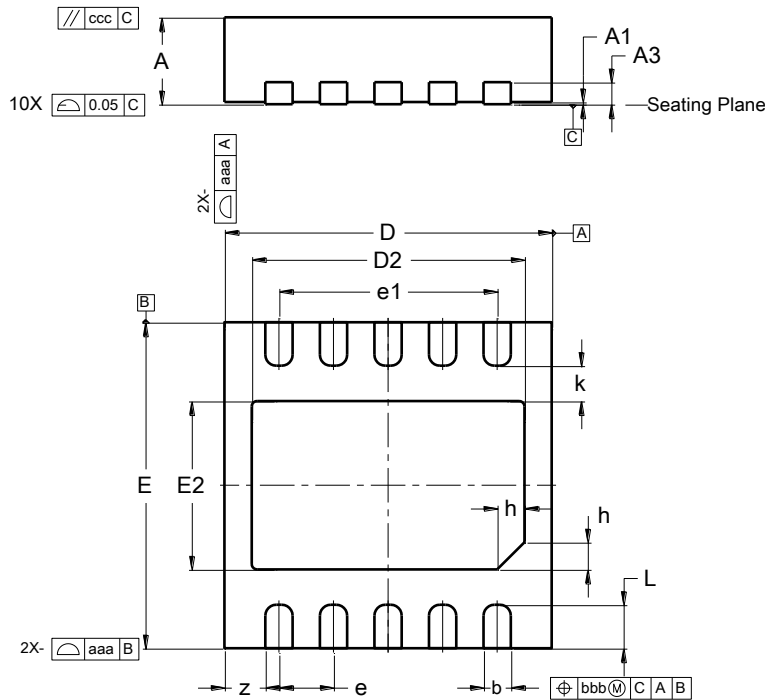

Figure 25. Offset Supply Leakage Current vs. Temperature

## Package Outline Dimensions

Please see <http://www.diodes.com/package-outlines.html> for the latest version.

**V-DFN3030-10 (Standard)**



V-DFN3030-10 (Standard)			
Dim	Min	Max	Typ
A	0.75	0.85	0.80
A1	0.00	0.05	0.02
A3	--	--	0.203
b	0.18	0.30	0.25
D	2.90	3.10	3.00
D2	2.40	2.60	2.50
e	0.50BSC		
e1	2.00BSC		
E	2.90	3.10	3.00
E2	1.45	1.65	1.55
h	0.20	0.30	0.25
k	--	--	0.325
L	0.30	0.50	0.40
z	--	--	0.325
aaa	0.250		
bbb	0.100		
ccc	0.050		
All Dimensions in mm			

## Suggested Pad Layout

Please see <http://www.diodes.com/package-outlines.html> for the latest version.

**V-DFN3030-10 (Standard)**

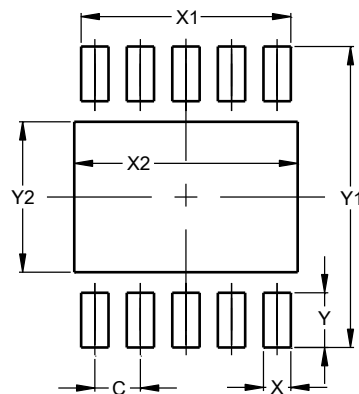

Dimensions	Value (in mm)
C	0.500
X	0.300
X1	2.300
X2	2.600
Y	0.600
Y1	3.300
Y2	1.650

**IMPORTANT NOTICE**

1. DIODES INCORPORATED (Diodes) AND ITS SUBSIDIARIES MAKE NO WARRANTY OF ANY KIND, EXPRESS OR IMPLIED, WITH REGARDS TO ANY INFORMATION CONTAINED IN THIS DOCUMENT, INCLUDING, BUT NOT LIMITED TO, THE IMPLIED WARRANTIES OF MERCHANTABILITY, FITNESS FOR A PARTICULAR PURPOSE OR NON-INFRINGEMENT OF THIRD PARTY INTELLECTUAL PROPERTY RIGHTS (AND THEIR EQUIVALENTS UNDER THE LAWS OF ANY JURISDICTION).
2. The Information contained herein is for informational purpose only and is provided only to illustrate the operation of Diodes' products described herein and application examples. Diodes does not assume any liability arising out of the application or use of this document or any product described herein. This document is intended for skilled and technically trained engineering customers and users who design with Diodes' products. Diodes' products may be used to facilitate safety-related applications; however, in all instances customers and users are responsible for (a) selecting the appropriate Diodes products for their applications, (b) evaluating the suitability of Diodes' products for their intended applications, (c) ensuring their applications, which incorporate Diodes' products, comply the applicable legal and regulatory requirements as well as safety and functional-safety related standards, and (d) ensuring they design with appropriate safeguards (including testing, validation, quality control techniques, redundancy, malfunction prevention, and appropriate treatment for aging degradation) to minimize the risks associated with their applications.
3. Diodes assumes no liability for any application-related information, support, assistance or feedback that may be provided by Diodes from time to time. Any customer or user of this document or products described herein will assume all risks and liabilities associated with such use, and will hold Diodes and all companies whose products are represented herein or on Diodes' websites, harmless against all damages and liabilities.
4. Products described herein may be covered by one or more United States, international or foreign patents and pending patent applications. Product names and markings noted herein may also be covered by one or more United States, international or foreign trademarks and trademark applications. Diodes does not convey any license under any of its intellectual property rights or the rights of any third parties (including third parties whose products and services may be described in this document or on Diodes' website) under this document.
5. Diodes' products are provided subject to Diodes' Standard Terms and Conditions of Sale (<https://www.diodes.com/about/company/terms-and-conditions/terms-and-conditions-of-sales/>) or other applicable terms. This document does not alter or expand the applicable warranties provided by Diodes. Diodes does not warrant or accept any liability whatsoever in respect of any products purchased through unauthorized sales channel.
6. Diodes' products and technology may not be used for or incorporated into any products or systems whose manufacture, use or sale is prohibited under any applicable laws and regulations. Should customers or users use Diodes' products in contravention of any applicable laws or regulations, or for any unintended or unauthorized application, customers and users will (a) be solely responsible for any damages, losses or penalties arising in connection therewith or as a result thereof, and (b) indemnify and hold Diodes and its representatives and agents harmless against any and all claims, damages, expenses, and attorney fees arising out of, directly or indirectly, any claim relating to any noncompliance with the applicable laws and regulations, as well as any unintended or unauthorized application.
7. While efforts have been made to ensure the information contained in this document is accurate, complete and current, it may contain technical inaccuracies, omissions and typographical errors. Diodes does not warrant that information contained in this document is error-free and Diodes is under no obligation to update or otherwise correct this information. Notwithstanding the foregoing, Diodes reserves the right to make modifications, enhancements, improvements, corrections or other changes without further notice to this document and any product described herein. This document is written in English but may be translated into multiple languages for reference. Only the English version of this document is the final and determinative format released by Diodes.
8. Any unauthorized copying, modification, distribution, transmission, display or other use of this document (or any portion hereof) is prohibited. Diodes assumes no responsibility for any losses incurred by the customers or users or any third parties arising from any such unauthorized use.
9. This Notice may be periodically updated with the most recent version available at <https://www.diodes.com/about/company/terms-and-conditions/important-notice>

The Diodes logo is a registered trademark of Diodes Incorporated in the United States and other countries.  
All other trademarks are the property of their respective owners.  
© 2024 Diodes Incorporated. All Rights Reserved.

[www.diodes.com](http://www.diodes.com)

## Looking for pricing, stock, or lifecycle information?

Click below to explore more details on WIN SOURCE:

-  [View DGD05473FN-7 on WIN SOURCE](#)
-  [Diodes Incorporated Information](#)

## Optimize Your Supply Chain with WIN SOURCE Solutions

-  Global Sourcing Solution
-  Obsolete Management
-  Cost Control Management
-  Shortage Management
-  Alternative Solution
-  Excess Inventory Management