



**THE DATASHEET OF  
AT91RM9200-QU-002**



## Features

- Incorporates the ARM920T™ ARM® Thumb® Processor
  - 200 MIPS at 180 MHz, Memory Management Unit
  - 16-KByte Data Cache, 16-KByte Instruction Cache, Write Buffer
  - In-circuit Emulator including Debug Communication Channel
  - Mid-level Implementation Embedded Trace Macrocell™ (256-ball BGA Package only)
- Low Power: On VDDCORE 24.4 mA in Normal Mode, 520 µA in Standby Mode
- Additional Embedded Memories
  - 16K Bytes of SRAM and 128K Bytes of ROM
- External Bus Interface (EBI)
  - Supports SDRAM, Static Memory, Burst Flash, Glueless Connection to CompactFlash® and NAND Flash/SmartMedia®
- System Peripherals for Enhanced Performance:
  - Enhanced Clock Generator and Power Management Controller
  - Two On-chip Oscillators with Two PLLs
  - Very Slow Clock Operating Mode and Software Power Optimization Capabilities
  - Four Programmable External Clock Signals
  - System Timer Including Periodic Interrupt, Watchdog and Second Counter
  - Real-time Clock with Alarm Interrupt
  - Debug Unit, Two-wire UART and Support for Debug Communication Channel
  - Advanced Interrupt Controller with 8-level Priority, Individually Maskable Vectored Interrupt Sources, Spurious Interrupt Protected
  - Seven External Interrupt Sources and One Fast Interrupt Source
  - Four 32-bit PIO Controllers with Up to 122 Programmable I/O Lines, Input Change Interrupt and Open-drain Capability on Each Line
  - 20-channel Peripheral DMA Controller (PDC)
- Ethernet MAC 10/100 Base-T
  - Media Independent Interface (MII) or Reduced Media Independent Interface (RMII)
  - Integrated 28-byte FIFOs and Dedicated DMA Channels for Receive and Transmit
- USB 2.0 Full Speed (12 Mbits per second) Host Double Port
  - Dual On-chip Transceivers (Single Port Only on 208-lead PQFP Package)
  - Integrated FIFOs and Dedicated DMA Channels
- USB 2.0 Full Speed (12 Mbits per second) Device Port
  - On-chip Transceiver, 2-Kbyte Configurable Integrated FIFOs
- Multimedia Card Interface (MCI)
  - Automatic Protocol Control and Fast Automatic Data Transfers
  - MMC and SD Memory Card-compliant, Supports Up to Two SD Memory Cards
- Three Synchronous Serial Controllers (SSC)
  - Independent Clock and Frame Sync Signals for Each Receiver and Transmitter
  - I<sup>2</sup>S Analog Interface Support, Time Division Multiplex Support
  - High-speed Continuous Data Stream Capabilities with 32-bit Data Transfer
- Four Universal Synchronous/Asynchronous Receiver/Transmitters (USART)
  - Support for ISO7816 T0/T1 Smart Card
  - Hardware Handshaking
  - RS485 Support, IrDA® Up To 115 Kbps
  - Full Modem Control Lines on USART1
- Master/Slave Serial Peripheral Interface (SPI)
  - 8- to 16-bit Programmable Data Length, 4 External Peripheral Chip Selects



## ARM920T-based Microcontroller

### AT91RM9200

**NOTE:** This is a summary document.  
The complete document is available on  
the Atmel website at [www.atmel.com](http://www.atmel.com).

1768MS-ATARM-09-Jul-09



- **Two 3-channel, 16-bit Timer/Counters (TC)**
  - Three External Clock Inputs, Two Multi-purpose I/O Pins per Channel
  - Double PWM Generation, Capture/Waveform Mode, Up/Down Capability
- **Two-wire Interface (TWI)**
  - Master Mode Support, All 2-wire Atmel EEPROMs Supported
- **IEEE® 1149.1 JTAG Boundary Scan on All Digital Pins**
- **Power Supplies**
  - 1.65V to 1.95V for VDDCORE, VDDOSC and VDDPLL
  - 3.0V to 3.6V for VDDIOP (Peripheral I/Os) and for VDDIOM (Memory I/Os)
- **Available in a 208-pin Green PQFP or 256-ball RoHS-compliant BGA Package**

## 1. Description

The AT91RM9200 is a complete system-on-chip built around the ARM920T ARM Thumb processor. It incorporates a rich set of system and application peripherals and standard interfaces in order to provide a single-chip solution for a wide range of compute-intensive applications that require maximum functionality at minimum power consumption at lowest cost.

The AT91RM9200 incorporates a high-speed on-chip SRAM workspace, and a low-latency External Bus Interface (EBI) for seamless connection to whatever configuration of off-chip memories and memory-mapped peripherals is required by the application. The EBI incorporates controllers for synchronous DRAM (SDRAM), Burst Flash and Static memories and features specific circuitry facilitating the interface for NAND Flash/SmartMedia and Compact Flash.

The Advanced Interrupt Controller (AIC) enhances the interrupt handling performance of the ARM920T processor by providing multiple vectored, prioritized interrupt sources and reducing the time taken to transfer to an interrupt handler.

The Peripheral DMA Controller (PDC) provides DMA channels for all the serial peripherals, enabling them to transfer data to or from on- and off-chip memories without processor intervention. This reduces the processor overhead when dealing with transfers of continuous data streams. The AT91RM9200 benefits from a new generation of PDC which includes dual pointers that simplify significantly buffer chaining.

The set of Parallel I/O (PIO) controllers multiplex the peripheral input/output lines with general-purpose data I/Os for maximum flexibility in device configuration. An input change interrupt, open drain capability and programmable pull-up resistor is included on each line.

The Power Management Controller (PMC) keeps system power consumption to a minimum by selectively enabling/disabling the processor and various peripherals under software control. It uses an enhanced clock generator to provide a selection of clock signals including a slow clock (32 kHz) to optimize power consumption and performance at all times.

The AT91RM9200 integrates a wide range of standard interfaces including USB 2.0 Full Speed Host and Device and Ethernet 10/100 Base-T Media Access Controller (MAC), which provides connection to a extensive range of external peripheral devices and a widely used networking layer. In addition, it provides an extensive set of peripherals that operate in accordance with several industry standards, such as those used in audio, telecom, Flash Card, infrared and Smart Card applications.

To complete the offer, the AT91RM9200 benefits from the integration of a wide range of debug features including JTAG-ICE, a dedicated UART debug channel (DBGU) and an embedded real time trace. This enables the development and debug of all applications, especially those with real-time constraints.

## 2. Block Diagram

Bold arrows ( **————>** ) indicate master-to-slave dependency.

Figure 2-1. AT91RM9200 Block Diagram

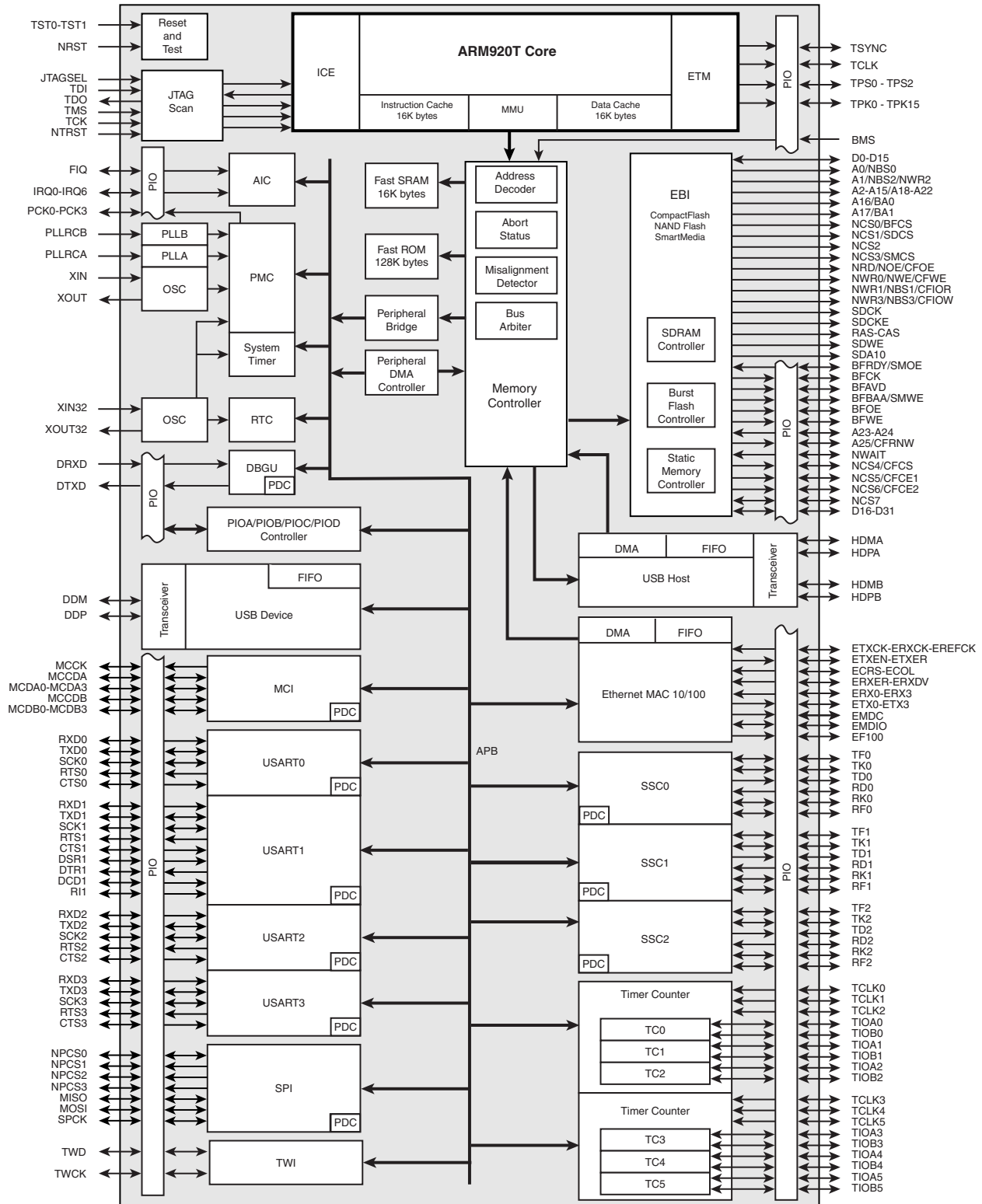

### 3. Signal Description

**Table 3-1.** Signal Description by Peripheral

Pin Name	Function	Type	Active Level	Comments
<b>Power</b>				
VDDIOM	Memory I/O Lines Power Supply	Power		3.0V to 3.6V
VDDIOP	Peripheral I/O Lines Power Supply	Power		3.0V to 3.6V
VDDPLL	Oscillator and PLL Power Supply	Power		1.65V to 1.95V
VDDCORE	Core Chip Power Supply	Power		1.65V to 1.95V
VDDOSC	Oscillator Power Supply	Power		1.65V to 1.95V
GND	Ground	Ground		
GNDPLL	PLL Ground	Ground		
GNDOSC	Oscillator Ground	Ground		
<b>Clocks, Oscillators and PLLs</b>				
XIN	Main Crystal Input	Input		
XOUT	Main Crystal Output	Output		
XIN32	32KHz Crystal Input	Input		
XOUT32	32KHz Crystal Output	Output		
PLLRC A	PLL A Filter	Input		
PLLRC B	PLL B Filter	Input		
PCK0 - PCK3	Programmable Clock Output	Output		
<b>ICE and JTAG</b>				
TCK	Test Clock	Input		Schmitt trigger
TDI	Test Data In	Input		Internal Pull-up, Schmitt trigger
TDO	Test Data Out	Output		Tri-state
TMS	Test Mode Select	Input		Internal Pull-up, Schmitt trigger
NTRST	Test Reset Signal	Input	Low	Internal Pull-up, Schmitt trigger
JTAGSEL	JTAG Selection	Input		Schmitt trigger
<b>ETM™</b>				
TSYNC	Trace Synchronization Signal	Output		
TCLK	Trace Clock	Output		
TPS0 - TPS2	Trace ARM Pipeline Status	Output		
TPK0 - TPK15	Trace Packet Port	Output		
<b>Reset/Test</b>				
NRST	Microcontroller Reset	Input	Low	No on-chip pull-up, Schmitt trigger
TST0 - TST1	Test Mode Select	Input		Must be tied low for normal operation, Schmitt trigger

**Table 3-1.** Signal Description by Peripheral

Pin Name	Function	Type	Active Level	Comments
<b>Memory Controller</b>				
BMS	Boot Mode Select	Input		
<b>Debug Unit</b>				
DRXD	Debug Receive Data	Input		Debug Receive Data
DTXD	Debug Transmit Data	Output		Debug Transmit Data
<b>AIC</b>				
IRQ0 - IRQ6	External Interrupt Inputs	Input		
FIQ	Fast Interrupt Input	Input		
<b>PIO</b>				
PA0 - PA31	Parallel IO Controller A	I/O		Pulled-up input at reset
PB0 - PB29	Parallel IO Controller B	I/O		Pulled-up input at reset
PC0 - PC31	Parallel IO Controller C	I/O		Pulled-up input at reset
PD0 - PD27	Parallel IO Controller D	I/O		Pulled-up input at reset
<b>EBI</b>				
D0 - D31	Data Bus	I/O		Pulled-up input at reset
A0 - A25	Address Bus	Output		0 at reset
<b>SMC</b>				
NCS0 - NCS7	Chip Select Lines	Output	Low	1 at reset
NWR0 - NWR3	Write Signal	Output	Low	1 at reset
NOE	Output Enable	Output	Low	1 at reset
NRD	Read Signal	Output	Low	1 at reset
NUB	Upper Byte Select	Output	Low	1 at reset
NLB	Lower Byte Select	Output	Low	1 at reset
NWE	Write Enable	Output	Low	1 at reset
NWAIT	Wait Signal	Input	Low	
NBS0 - NBS3	Byte Mask Signal	Output	Low	1 at reset
<b>EBI for CompactFlash Support</b>				
CFCE1 - CFCE2	CompactFlash Chip Enable	Output	Low	
CFOE	CompactFlash Output Enable	Output	Low	
CFWE	CompactFlash Write Enable	Output	Low	
CFIOR	CompactFlash IO Read	Output	Low	
CFIOW	CompactFlash IO Write	Output	Low	
CFRNW	CompactFlash Read Not Write	Output		
CFCS	CompactFlash Chip Select	Output	Low	

**Table 3-1. Signal Description by Peripheral**

Pin Name	Function	Type	Active Level	Comments
<b>EBI for NAND Flash/SmartMedia Support</b>				
SMCS	NAND Flash/SmartMedia Chip Select	Output	Low	
SMOE	NAND Flash/SmartMedia Output Enable	Output	Low	
SMWE	NAND Flash/SmartMedia Write Enable	Output	Low	
<b>SDRAM Controller</b>				
SDCK	SDRAM Clock	Output		
SDCKE	SDRAM Clock Enable	Output	High	
SDCS	SDRAM Controller Chip Select	Output	Low	
BA0 - BA1	Bank Select	Output		
SDWE	SDRAM Write Enable	Output	Low	
RAS - CAS	Row and Column Signal	Output	Low	
SDA10	SDRAM Address 10 Line	Output		
<b>Burst Flash Controller</b>				
BFCK	Burst Flash Clock	Output		
BFCS	Burst Flash Chip Select	Output	Low	
BFAVD	Burst Flash Address Valid	Output	Low	
BFBA	Burst Flash Address Advance	Output	Low	
BFOE	Burst Flash Output Enable	Output	Low	
BFRDY	Burst Flash Ready	Input	High	
BFWE	Burst Flash Write Enable	Output	Low	
<b>Multimedia Card Interface</b>				
MCK	Multimedia Card Clock	Output		
MCCDA	Multimedia Card A Command	I/O		
MCDA0 - MCDA3	Multimedia Card A Data	I/O		
MCCDB	Multimedia Card B Command	I/O		
MCDB0 - MCDB3	Multimedia Card B Data	I/O		
<b>USART</b>				
SCK0 - SCK3	Serial Clock	I/O		
TXD0 - TXD3	Transmit Data	Output		
RXD0 - RXD3	Receive Data	Input		
RTS0 - RTS3	Ready To Send	Output		
CTS0 - CTS3	Clear To Send	Input		
DSR1	Data Set Ready	Input		
DTR1	Data Terminal Ready	Output		
DCD1	Data Carrier Detect	Input		
RI1	Ring Indicator	Input		

**Table 3-1.** Signal Description by Peripheral

Pin Name	Function	Type	Active Level	Comments
<b>USB Device Port</b>				
DDM	USB Device Port Data -	Analog		
DDP	USB Device Port Data +	Analog		
<b>USB Host Port</b>				
HDMA	USB Host Port A Data -	Analog		
HDPA	USB Host Port A Data +	Analog		
HDMB	USB Host Port B Data -	Analog		
HDPB	USB Host Port B Data +	Analog		
<b>Ethernet MAC</b>				
EREFCK	Reference Clock	Input		RMII only
ETXCK	Transmit Clock	Input		MII only
ERXCK	Receive Clock	Input		MII only
ETXEN	Transmit Enable	Output		
ETX0 - ETX3	Transmit Data	Output		ETX0 - ETX1 only in RMII
ETXER	Transmit Coding Error	Output		MII only
ERXDV	Receive Data Valid	Input		MII only
ECRSDV	Carrier Sense and Data Valid	Input		RMII only
ERX0 - ERX3	Receive Data	Input		ERX0 - ERX1 only in RMII
ERXER	Receive Error	Input		
ECRS	Carrier Sense	Input		MII only
ECOL	Collision Detected	Input		MII only
EMDC	Management Data Clock	Output		
EMDIO	Management Data Input/Output	I/O		
EF100	Force 100 Mbts/sec.	Output	High	RMII only
<b>Synchronous Serial Controller</b>				
TD0 - TD2	Transmit Data	Output		
RD0 - RD2	Receive Data	Input		
TK0 - TK2	Transmit Clock	I/O		
RK0 - RK2	Receive Clock	I/O		
TF0 - TF2	Transmit Frame Sync	I/O		
RF0 - RF2	Receive Frame Sync	I/O		
<b>Timer/Counter</b>				
TCLK0 - TCLK5	External Clock Input	Input		
TIOA0 - TIOA5	I/O Line A	I/O		
TIOB0 - TIOB5	I/O Line B	I/O		

**Table 3-1.** Signal Description by Peripheral

Pin Name	Function	Type	Active Level	Comments
<b>SPI</b>				
MISO	Master In Slave Out	I/O		
MOSI	Master Out Slave In	I/O		
SPCK	SPI Serial Clock	I/O		
NPCS0	SPI Peripheral Chip Select 0	I/O	Low	
NPCS1 - NPCS3	SPI Peripheral Chip Select	Output	Low	
<b>Two-Wire Interface</b>				
TWD	Two-wire Serial Data	I/O		
TWCK	Two-wire Serial Clock	I/O		

## 4. Package and Pinout

The AT91RM9200 is available in two packages:

- 208-pin PQFP, 31.2 x 31.2 mm, 0.5 mm pitch
- 256-ball BGA, 15 x 15 mm, 0.8 mm ball pitch

The product features of the 256-ball BGA package are extended compared to the 208-lead PQFP package. The features that are available only with the 256-ball BGA package are:

- Parallel I/O Controller D
- ETM port with outputs multiplexed on the PIO Controller D
- a second USB Host transceiver, opening the Hub capabilities of the embedded USB Host.

### 4.1 208-pin PQFP Package Outline

Figure 1-1 shows the orientation of the 208-pin PQFP package.

A detailed mechanical description is given in the section “AT91RM9200 Mechanical Characteristics” of the product datasheet.

**Figure 4-1.** 208-pin PQFP Package (Top View)

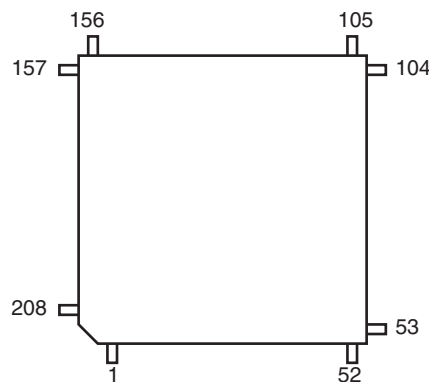

## 4.2 208-pin PQFP Package Pinout

Table 4-1. AT91RM9200 Pinout for 208-pin PQFP Package

Pin Number	Signal Name	Pin Number	Signal Name	Pin Number	Signal Name	Pin Number	Signal Name
1	PC24	37	VDDPLL	73	PA27	109	TMS
2	PC25	38	PLLRCB	74	PA28	110	NTRST
3	PC26	39	GNDPLL	75	VDDIOP	111	VDDIOP
4	PC27	40	VDDIOP	76	GND	112	GND
5	PC28	41	GND	77	PA29	113	TST0
6	PC29	42	PA0	78	PA30	114	TST1
7	VDDIOM	43	PA1	79	PA31/BMS	115	NRST
8	GND	44	PA2	80	PB0	116	VDDCORE
9	PC30	45	PA3	81	PB1	117	GND
10	PC31	46	PA4	82	PB2	118	PB23
11	PC10	47	PA5	83	PB3	119	PB24
12	PC11	48	PA6	84	PB4	120	PB25
13	PC12	49	PA7	85	PB5	121	PB26
14	PC13	50	PA8	86	PB6	122	PB27
15	PC14	51	PA9	87	PB7	123	PB28
16	PC15	52	PA10	88	PB8	124	PB29
17	PC0	53	PA11	89	PB9	125	HDMA
18	PC1	54	PA12	90	PB10	126	HDPA
19	VDDCORE	55	PA13	91	PB11	127	DDM
20	GND	56	VDDIOP	92	PB12	128	DDP
21	PC2	57	GND	93	VDDIOP	129	VDDIOP
22	PC3	58	PA14	94	GND	130	GND
23	PC4	59	PA15	95	PB13	131	VDDIOM
24	PC5	60	PA16	96	PB14	132	GND
25	PC6	61	PA17	97	PB15	133	A0/NBS0
26	VDDIOM	62	VDDCORE	98	PB16	134	A1/NBS2/NWR2
27	GND	63	GND	99	PB17	135	A2
28	VDDPLL	64	PA18	100	PB18	136	A3
29	PLLRCB	65	PA19	101	PB19	137	A4
30	GNDPLL	66	PA20	102	PB20	138	A5
31	XOUT	67	PA21	103	PB21	139	A6
32	XIN	68	PA22	104	PB22	140	A7
33	VDDOSC	69	PA23	105	JTAGSEL	141	A8
34	GNDOSC	70	PA24	106	TDI	142	A9
35	XOUT32	71	PA25	107	TDO	143	A10
36	XIN32	72	PA26	108	TCK	144	SDA10

**Table 4-1.** AT91RM9200 Pinout for 208-pin PQFP Package (Continued)

Pin Number	Signal Name	Pin Number	Signal Name	Pin Number	Signal Name	Pin Number	Signal Name
145	A11	161	PC7	177	CAS	193	D10
146	VDDIOM	162	PC8	178	SDWE	194	D11
147	GND	163	PC9	179	D0	195	D12
148	A12	164	VDDIOM	180	D1	196	D13
149	A13	165	GND	181	D2	197	D14
150	A14	166	NCS0/BFCS	182	D3	198	D15
151	A15	167	NCS1/SDCS	183	VDDIOM	199	VDDIOM
152	VDDCORE	168	NCS2	184	GND	200	GND
153	GND	169	NCS3/SMCS	185	D4	201	PC16
154	A16/BA0	170	NRD/NOE/CFOE	186	D5	202	PC17
155	A17/BA1	171	NWR0/NWE/CFWE	187	D6	203	PC18
156	A18	172	NWR1/NBS1/CFIOR	188	VDDCORE	204	PC19
157	A19	173	NWR3/NBS3/CFIOW	189	GND	205	PC20
158	A20	174	SDCK	190	D7	206	PC21
159	A21	175	SDCKE	191	D8	207	PC22
160	A22	176	RAS	192	D9	208	PC23

Note: 1. Shaded cells define the pins powered by VDDIOM.

### 4.3 256-ball BGA Package Outline

Figure 4-2 shows the orientation of the 256-ball LFBGA package.

A detailed mechanical description is given in the section “AT91RM9200 Mechanical Characteristics” of the product datasheet.

**Figure 4-2.** 256-ball LFBGA Package (Top View)

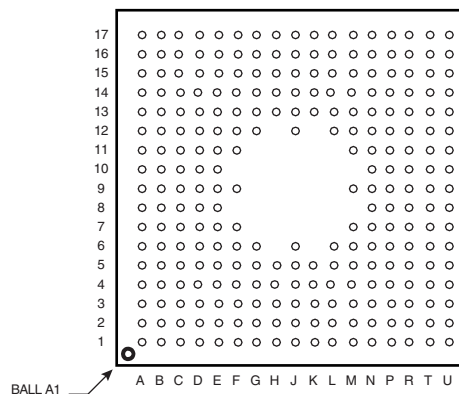

## 4.4 256-ball BGA Package Pinout

Table 4-2. AT91RM9200 Pinout for 256-ball BGA Package

Pin	Signal Name	Pin	Signal Name	Pin	Signal Name	Pin	Signal Name
A1	TDI	C3	PD14	E5	TCK	G14	PA1
A2	JTAGSEL	C4	PB22	E6	GND	G15	PA2
A3	PB20	C5	PB19	E7	PB15	G16	PA3
A4	PB17	C6	PD10	E8	GND	G17	XIN32
A5	PD11	C7	PB13	E9	PB7	H1	PD23
A6	PD8	C8	PB12	E10	PB3	H2	PD20
A7	VDDIOP	C9	PB6	E11	PA29	H3	PD22
A8	PB9	C10	PB1	E12	PA26	H4	PD21
A9	PB4	C11	GND	E13	PA25	H5	VDDIOP
A10	PA31/BMS	C12	PA20	E14	PA9	H13	VDDPLL
A11	VDDIOP	C13	PA18	E15	PA6	H14	VDDIOP
A12	PA23	C14	VDDCORE	E16	PD3	H15	GNDPLL
A13	PA19	C15	GND	E17	PD0	H16	GND
A14	GND	C16	PA8	F1	PD16	H17	XOUT32
A15	PA14	C17	PD5	F2	GND	J1	PD25
A16	VDDIOP	D1	TST1	F3	PB23	J2	PD27
A17	PA13	D2	VDDIOP	F4	PB25	J3	PD24
B1	TDO	D3	VDDIOP	F5	PB24	J4	PD26
B2	PD13	D4	GND	F6	VDDCORE	J5	PB28
B3	PB18	D5	VDDIOP	F7	PB16	J6	PB29
B4	PB21	D6	PD7	F9	PB11	J12	GND
B5	PD12	D7	PB14	F11	PA30	J13	GNDOSC
B6	PD9	D8	VDDIOP	F12	PA28	J14	VDDOSC
B7	GND	D9	PB8	F13	PA4	J15	VDDPLL
B8	PB10	D10	PB2	F14	PD2	J16	GNDPLL
B9	PB5	D11	GND	F15	PD1	J17	XIN
B10	PB0	D12	PA22	F16	PA5	K1	HDP A
B11	VDDIOP	D13	PA21	F17	PLLRCB	K2	DDM
B12	PA24	D14	PA16	G1	PD19	K3	HDMA
B13	PA17	D15	PA10	G2	PD17	K4	VDDIOP
B14	PA15	D16	PD6	G3	GND	K5	DDP
B15	PA11	D17	PD4	G4	PB26	K13	PC5
B16	PA12	E1	NRST	G5	PD18	K14	PC4
B17	PA7	E2	NTRST	G6	PB27	K15	PC6
C1	TMS	E3	GND	G12	PA27	K16	VDDIOM
C2	PD15	E4	TST0	G13	PA0	K17	XOUT

**Table 4-2. AT91RM9200 Pinout for 256-ball BGA Package (Continued)**

Pin	Signal Name	Pin	Signal Name	Pin	Signal Name	Pin	Signal Name
L1	GND	N2	A5	P13	D15	T7	NWR1/NBS1/ CFIOR
L2	HDPB	N3	A9	P14	PC26	T8	SDWE
L3	HDMB	N4	A4	P15	PC27	T9	GND
L4	A6	N5	A14	P16	VDDIOM	T10	VDDCORE
L5	GND	N6	SDA10	P17	GND	T11	D9
L6	VDDIOP	N7	A8	R1	GND	T12	D12
L12	PC10	N8	A21	R2	GND	T13	GND
L13	PC15	N9	NRD/NOE/CFOE	R3	A18	T14	PC19
L14	PC2	N10	RAS	R4	A20	T15	PC21
L15	PC3	N11	D2	R5	PC8	T16	PC23
L16	VDDCORE	N12	GND	R6	VDDIOM	T17	PC25
L17	PLLRCA	N13	PC28	R7	NCS3/SMCS	U1	VDDCORE
M1	VDDIOM	N14	PC31	R8	NWR3/NBS3/ CFIOW	U2	GND
M2	GND	N15	PC30	R9	D0	U3	A16/BA0
M3	A3	N16	PC11	R10	VDDIOM	U4	A19
M4	A1/NBS2/NWR2	N17	PC12	R11	D8	U5	GND
M5	A10	P1	A7	R12	D13	U6	NCS0/BFCS
M6	A2	P2	A13	R13	PC17	U7	SDCK
M7	GND	P3	A12	R14	VDDIOM	U8	CAS
M9	NCS1/SDCS	P4	VDDIOM	R15	PC24	U9	D3
M11	D4	P5	A11	R16	PC29	U10	D6
M12	GND	P6	A22	R17	VDDIOM	U11	D7
M13	PC13	P7	PC9	T1	A15	U12	D11
M14	PC1	P8	NWR0/NWE/CFWE	T2	VDDCORE	U13	D14
M15	PC0	P9	SDCKE	T3	A17/BA1	U14	PC16
M16	GND	P10	D1	T4	PC7	U15	PC18
M17	PC14	P11	D5	T5	VDDIOM	U16	PC20
N1	A0/NBS0	P12	D10	T6	NCS2	U17	PC22

Note: 1. Shaded cells define the balls powered by VDDIOM.

## 5. Power Considerations

### 5.1 Power Supplies

The AT91RM9200 has five types of power supply pins:

- VDDCORE pins. They power the core, including processor, memories and peripherals; voltage ranges from 1.65V to 1.95V, 1.8V nominal.
- VDDIOM pins. They power the External Bus Interface I/O lines; voltage ranges from 3.0V to 3.6V, 3V or 3.3V nominal.
- VDDIOP pins. They power the Peripheral I/O lines and the USB transceivers; voltage ranges from 3.0V to 3.6V, 3V or 3.3V nominal.
- VDDPLL pins. They power the PLL cells; voltage ranges from 1.65V to 1.95V, 1.8V nominal.
- VDDOSC pin. They power both oscillators; voltage ranges from 1.65V to 1.95V, 1.8V nominal.

The double power supplies VDDIOM and VDDIOP are identified in [Table 4-1 on page 9](#) and [Table 4-2 on page 11](#). These supplies enable the user to power the device differently for interfacing with memories and for interfacing with peripherals.

Ground pins are common to all power supplies, except VDDPLL and VDDOSC pins. For these pins, GNDPLL and GNDOSC are provided, respectively.

### 5.2 Power Consumption

The AT91RM9200 consumes about 500  $\mu$ A of static current on VDDCORE at 25 $\cdot$  C. For dynamic power consumption, the AT91RM9200 consumes a maximum of 25 mA on VDDCORE at maximum speed in typical conditions (1.8V, 25 $\cdot$  C), processor running full-performance algorithm.

## 6. I/O Considerations

### 6.1 JTAG Port Pins

TMS and TDI are Schmitt trigger inputs and integrate internal pull-up resistors of 15 kOhm typical. TCK is a Schmitt trigger input without internal pull-up resistor.

TDO is a tri-state output. The JTAGSEL pin is used to select the JTAG boundary scan when asserted at a high level. The NTRST pin is used to initialize the EmbeddedICE™ TAP Controller.

### 6.2 Test Pin

The TST0 and TST1 pins are used for manufacturing test purposes when asserted high. As they do not integrate a pull-down resistor, they must be tied low during normal operations. Driving this line at a high level leads to unpredictable results.

### 6.3 Reset Pin

NRST is a Schmitt trigger without pull-up resistor. The NRST signal is inserted in the Boundary Scan.

## 6.4 PIO Controller A, B, C and D Lines

All the I/O lines PA0 to PA31, PB0 to PB29, PC0 to PC31 and PD0 to PD27 integrate a programmable pull-up resistor of 15 kOhm typical. Programming of this pull-up resistor is performed independently for each I/O line through the PIO Controllers.

After reset, all the I/O lines default as inputs with pull-up resistors enabled, except those which are multiplexed with the External Bus Interface signals that must be enabled as peripherals at reset. This is explicitly indicated in the column "Reset State" of the PIO Controller multiplexing tables.

## 7. Processor and Architecture

### 7.1 ARM920T Processor

- ARM9TDMI™-based on ARM Architecture v4T
- Two instruction sets
  - ARM High-performance 32-bit Instruction Set
  - Thumb High Code Density 16-bit Instruction Set
- 5-Stage Pipeline Architecture:
  - Instruction Fetch (F)
  - Instruction Decode (D)
  - Execute (E)
  - Data Memory (M)
  - Register Write (W)
- 16-Kbyte Data Cache, 16-Kbyte Instruction Cache
  - Virtually-addressed 64-way Associative Cache
  - 8 words per line
  - Write-through and write-back operation
  - Pseudo-random or Round-robin replacement
  - Low-power CAM RAM implementation
- Write Buffer
  - 16-word Data Buffer
  - 4-address Address Buffer
  - Software Control Drain
- Standard ARMv4 Memory Management Unit (MMU)
  - Access permission for sections
  - Access permission for large pages and small pages can be specified separately for each quarter of the pages
  - 16 embedded domains
  - 64 Entry Instruction TLB and 64 Entry Data TLB

8-, 16-, 32-bit Data Bus for Instructions and Data

### 7.2 Debug and Test

- Integrated EmbeddedICE

- Debug Unit
  - Two-pin UART
  - Debug Communication Channel
  - Chip ID Register
- Embedded Trace Macrocell: ETM9™ Rev2a
  - Medium Level Implementation
  - Half-rate Clock Mode
  - Four Pairs of Address Comparators
  - Two Data Comparators
  - Eight Memory Map Decoder Inputs
  - Two Counters
  - One Sequencer
  - One 18-byte FIFO
- IEEE1149.1 JTAG Boundary Scan on all Digital Pins

## 7.3 Boot Program

- Default Boot Program stored in ROM-based products
- Downloads and runs an application from external storage media into internal SRAM
- Downloaded code size depends on embedded SRAM size
- Automatic detection of valid application
- Bootloader supporting a wide range of non-volatile memories
  - SPI DataFlash® connected on SPI NPCS0
  - Two-wire EEPROM
  - 8-bit parallel memories on NCS0
- Boot Uploader in case no valid program is detected in external NVM and supporting several communication media
- Serial communication on a DBGU (XModem protocol)
- USB Device Port (DFU Protocol)

## 7.4 Embedded Software Services

- Compliant with ATPCS
- Compliant with AINSI/ISO Standard C
- Compiled in ARM/Thumb Interworking
- ROM Entry Service
- Tempo, Xmodem and DataFlash services
- CRC and Sine tables

## 7.5 Memory Controller

- Programmable Bus Arbiter handling four Masters
  - Internal Bus is shared by ARM920T, PDC, USB Host Port and Ethernet MAC Masters
  - Each Master can be assigned a priority between 0 and 7

- Address Decoder provides selection for
  - Eight external 256-Mbyte memory areas
  - Four internal 1-Mbyte memory areas
  - One 256-Mbyte embedded peripheral area
- Boot Mode Select Option
  - Non-volatile Boot Memory can be internal or external
  - Selection is made by BMS pin sampled at reset
- Abort Status Registers
  - Source, Type and all parameters of the access leading to an abort are saved
- Misalignment Detector
  - Alignment checking of all data accesses
  - Abort generation in case of misalignment
- Remap command
  - Provides remapping of an internal SRAM in place of the boot NVM

## 8. Memories

Figure 8-1. AT91RM9200 Memory Mapping

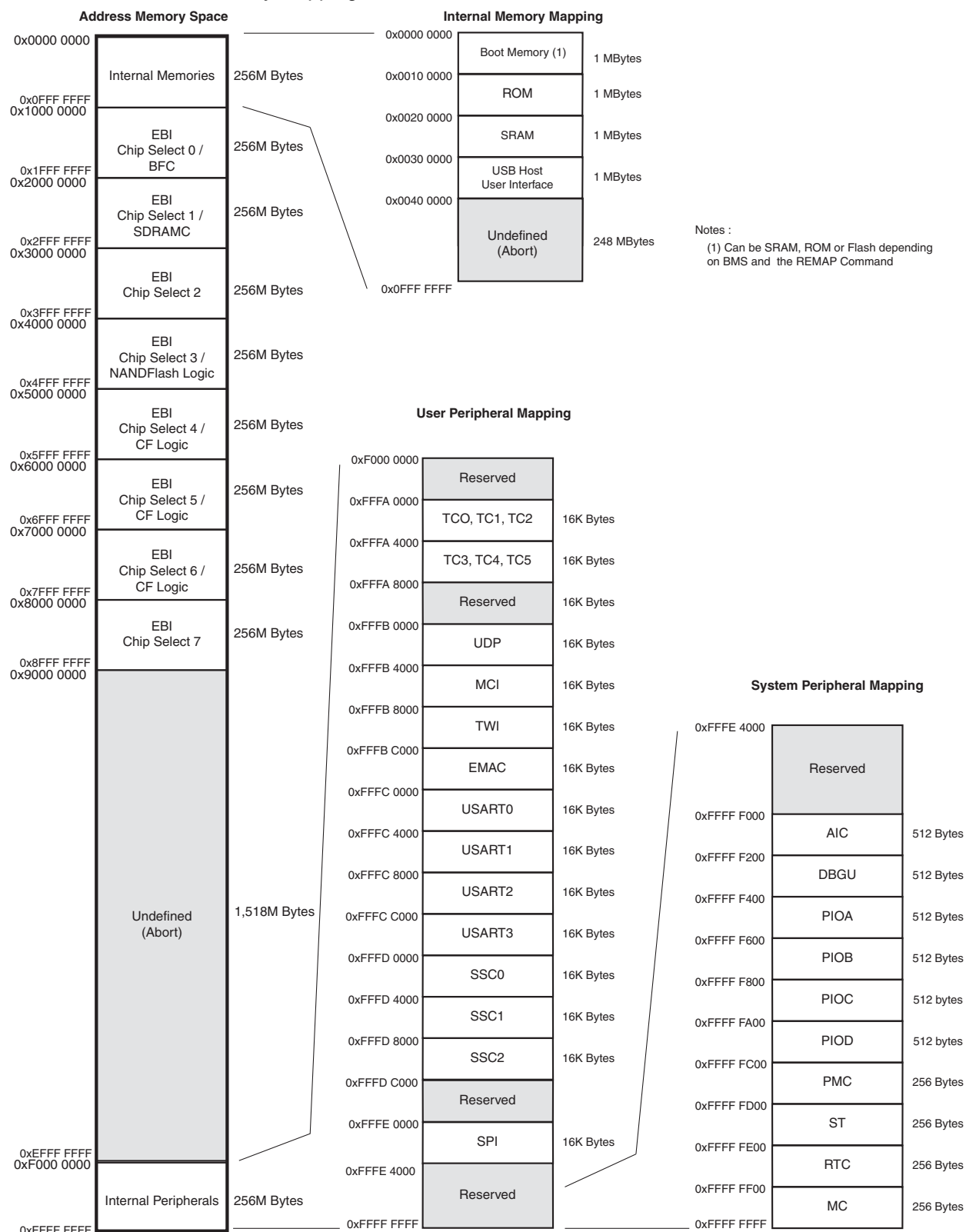

A first level of address decoding is performed by the Memory Controller, i.e., by the implementation of the Advanced System Bus (ASB) with additional features.

Decoding splits the 4G bytes of address space into 16 areas of 256M bytes. The areas 1 to 8 are directed to the EBI that associates these areas to the external chip selects NC0 to NCS7. The area 0 is reserved for the addressing of the internal memories, and a second level of decoding provides 1M bytes of internal memory area. The area 15 is reserved for the peripherals and provides access to the Advanced Peripheral Bus (APB).

Other areas are unused and performing an access within them provides an abort to the master requesting such an access.

## 8.1 Embedded Memories

### 8.1.1 Internal Memory Mapping

#### 8.1.1.1 *Internal RAM*

The AT91RM9200 integrates a high-speed, 16-Kbyte internal SRAM. After reset and until the Remap Command is performed, the SRAM is only accessible at address 0x20 0000. After Remap, the SRAM is also available at address 0x0.

#### 8.1.1.2 *Internal ROM*

The AT91RM9200 integrates a 128-Kbyte Internal ROM. At any time, the ROM is mapped at address 0x10 0000. It is also accessible at address 0x0 after reset and before the Remap Command if the BMS is tied high during reset.

#### 8.1.1.3 *USB Host Port*

The AT91RM9200 integrates a USB Host Port Open Host Controller Interface (OHCI). The registers of this interface are directly accessible on the ASB Bus and are mapped like a standard internal memory at address 0x30 0000.

## 9. System Peripherals

A complete memory map is shown in [Figure 8-1 on page 17](#).

### 9.1 Reset Controller

- Two reset input lines (NRST and NTRST) providing, respectively:
- Initialization of the User Interface registers (defined in the user interface of each peripheral) and:
  - Sample the signals needed at bootup
  - Compel the processor to fetch the next instruction at address zero
- Initialization of the embedded ICE TAP controller

### 9.2 Advanced Interrupt Controller

- Controls the interrupt lines (nIRQ and nFIQ) of an ARM Processor
- Thirty-two individually maskable and vectored interrupt sources
  - Source 0 is reserved for the Fast Interrupt Input (FIQ)
  - Source 1 is reserved for system peripherals (ST, RTC, PMC, DBGU...)
  - Source 2 to Source 31 control thirty embedded peripheral interrupts or external interrupts
  - Programmable Edge-triggered or Level-sensitive Internal Sources
  - Programmable Positive/Negative Edge-triggered or High/Low Level-sensitive External Sources
- 8-level Priority Controller
  - Drives the Normal Interrupt of the processor
  - Handles priority of the interrupt sources 1 to 31
  - Higher priority interrupts can be served during service of lower priority interrupt
- Vectoring
  - Optimizes Interrupt Service Routine Branch and Execution
  - One 32-bit Vector Register per interrupt source
  - Interrupt Vector Register reads the corresponding current Interrupt Vector
- Protect Mode
  - Easy debugging by preventing automatic operations
- General Interrupt Mask
  - Provides processor synchronization on events without triggering an interrupt

### 9.3 Power Management Controller

- Optimizes the power consumption of the whole system
- Embeds and controls:
  - One Main Oscillator and One Slow Clock Oscillator (32.768Hz)
  - Two Phase Locked Loops (PLLs) and Dividers
  - Clock Prescalers
- Provides:
  - the Processor Clock PCK

- the Master Clock MCK
- the USB Clocks, UHPCK and UDPCK, respectively for the USB Host Port and the USB Device Port
- Programmable automatic PLL switch-off in USB Device suspend conditions
- up to thirty peripheral clocks
- four programmable clock outputs PCK0 to PCK3
- Four operating modes:
  - Normal Mode, Idle Mode, Slow Clock Mode, Standby Mode

## 9.4 Debug Unit

- System peripheral to facilitate debug of Atmel's ARM-based systems
- Composed of the following functions
  - Two-pin UART
  - Debug Communication Channel (DCC) support
  - Chip ID Registers
- Two-pin UART
  - Implemented features are 100% compatible with the standard Atmel USART
  - Independent receiver and transmitter with a common programmable Baud Rate Generator
  - Even, Odd, Mark or Space Parity Generation
  - Parity, Framing and Overrun Error Detection
  - Automatic Echo, Local Loopback and Remote Loopback Channel Modes
  - Interrupt generation
  - Support for two PDC channels with connection to receiver and transmitter
- Debug Communication Channel Support
  - Offers visibility of COMMRX and COMMTX signals from the ARM Processor
  - Interrupt generation
- Chip ID Registers
  - Identification of the device revision, sizes of the embedded memories, set of peripherals

## 9.5 PIO Controller

- Up to 32 programmable I/O Lines
- Fully programmable through Set/Clear Registers
- Multiplexing of two peripheral functions per I/O Line
- For each I/O Line (whether assigned to a peripheral or used as general purpose I/O)
  - Input change interrupt
  - Glitch filter
  - Multi-drive option enables driving in open drain
  - Programmable pull up on each I/O line
  - Pin data status register, supplies visibility of the level on the pin at any time

- Synchronous output, provides Set and Clear of several I/O lines in a single write

## 10. User Peripherals

### 10.1 User Interface

The User Peripherals are mapped in the upper 256M bytes of the address space, between the addresses 0xFFFA 0000 and 0xFFFE 3FFF. Each peripheral has a 16-Kbyte address space.

A complete memory map is presented in [Figure 8-1 on page 17](#).

### 10.2 Peripheral Identifiers

The AT91RM9200 embeds a wide range of peripherals. [Table 10-1](#) defines the peripheral identifiers of the AT91RM9200. A peripheral identifier is required for the control of the peripheral interrupt with the Advanced Interrupt Controller and for the control of the peripheral clock with the Power Management Controller.

**Table 10-1.** Peripheral Identifiers

Peripheral ID	Peripheral Mnemonic	Peripheral Name	External Interrupt
0	AIC	Advanced Interrupt Controller	FIQ
1	SYSIRQ		
2	PIOA	Parallel I/O Controller A	
3	PIOB	Parallel I/O Controller B	
4	PIOC	Parallel I/O Controller C	
5	PIOD	Parallel I/O Controller D	
6	US0	USART 0	
7	US1	USART 1	
8	US2	USART 2	
9	US3	USART 3	
10	MCI	Multimedia Card Interface	
11	UDP	USB Device Port	
12	TWI	Two-wire Interface	
13	SPI	Serial Peripheral Interface	
14	SSC0	Synchronous Serial Controller 0	
15	SSC1	Synchronous Serial Controller 1	
16	SSC2	Synchronous Serial Controller 2	
17	TC0	Timer/Counter 0	
18	TC1	Timer/Counter 1	
19	TC2	Timer/Counter 2	
20	TC3	Timer/Counter 3	
21	TC4	Timer/Counter 4	
22	TC5	Timer/Counter 5	
23	UHP	USB Host Port	

**Table 10-1.** Peripheral Identifiers (Continued)

Peripheral ID	Peripheral Mnemonic	Peripheral Name	External Interrupt
24	EMAC	Ethernet MAC	
25	AIC	Advanced Interrupt Controller	IRQ0
26	AIC	Advanced Interrupt Controller	IRQ1
27	AIC	Advanced Interrupt Controller	IRQ2
28	AIC	Advanced Interrupt Controller	IRQ3
29	AIC	Advanced Interrupt Controller	IRQ4
30	AIC	Advanced Interrupt Controller	IRQ5
31	AIC	Advanced Interrupt Controller	IRQ6

### 10.3 Peripheral Multiplexing on PIO Lines

The AT91RM9200 features four PIO controllers:

- PIOA and PIOB, multiplexing I/O lines of the peripheral set
- PIOC, multiplexing the data bus bits 16 to 31 and several External Bus Interface control signals. Using PIOC pins increases the number of general-purpose I/O lines available but prevents 32-bit memory access
- PIOD, available in the 256-ball BGA package option only, multiplexing outputs of the peripheral set and the ETM port

Each PIO Controller controls up to 32 lines. Each line can be assigned to one of two peripheral functions, A or B. The tables in the following paragraphs define how the I/O lines of the peripherals A and B are multiplexed on the PIO Controllers A, B, C and D. The two columns “Function” and “Comments” have been inserted for the user’s own comments; they may be used to track how pins are defined in an application.

The column “Reset State” indicates whether the PIO line resets in I/O mode or in peripheral mode. If equal to “I/O”, the PIO line resets in input with the pull-up enabled so that the device is maintained in a static state as soon as the NRST pin is asserted. As a result, the bit corresponding to the PIO line in the register PIO\_PSR (Peripheral Status Register) resets low.

If a signal name is in the “Reset State” column, the PIO line is assigned to this function and the corresponding bit in PIO\_PSR resets high. This is the case for pins controlling memories, either address lines or chip selects, and that require the pin to be driven as soon as NRST raises. Note that the pull-up resistor is also enabled in this case.

See [Table 10-2 on page 23](#), [Table 10-3 on page 24](#), [Table 10-4 on page 25](#) and [Table 10-5 on page 26](#).

## 10.3.1 PIO Controller A Multiplexing

**Table 10-2.** Multiplexing on PIO Controller A

PIO Controller A				Application Usage	
I/O Line	Peripheral A	Peripheral B	Reset State	Function	Comments
PA0	MISO	PCK3	I/O		
PA1	MOSI	PCK0	I/O		
PA2	SPCK	IRQ4	I/O		
PA3	NPCS0	IRQ5	I/O		
PA4	NPCS1	PCK1	I/O		
PA5	NPCS2	TXD3	I/O		
PA6	NPCS3	RXD3	I/O		
PA7	ETXCK/EREFCK	PCK2	I/O		
PA8	ETXEN	MCCDB	I/O		
PA9	ETX0	MCDB0	I/O		
PA10	ETX1	MCDB1	I/O		
PA11	ECRS/ECRSVD	MCDB2	I/O		
PA12	ERX0	MCDB3	I/O		
PA13	ERX1	TCLK0	I/O		
PA14	ERXER	TCLK1	I/O		
PA15	EMDC	TCLK2	I/O		
PA16	EMDIO	IRQ6	I/O		
PA17	TXD0	TIOA0	I/O		
PA18	RXD0	TIOB0	I/O		
PA19	SCK0	TIOA1	I/O		
PA20	CTS0	TIOB1	I/O		
PA21	RTS0	TIOA2	I/O		
PA22	RXD2	TIOB2	I/O		
PA23	TXD2	IRQ3	I/O		
PA24	SCK2	PCK1	I/O		
PA25	TWD	IRQ2	I/O		
PA26	TWCK	IRQ1	I/O		
PA27	MCCK	TCLK3	I/O		
PA28	MCCDA	TCLK4	I/O		
PA29	MCDA0	TCLK5	I/O		
PA30	DRXD	CTS2	I/O		
PA31	DTXD	RTS2	I/O		

### 10.3.2 PIO Controller B Multiplexing

**Table 10-3.** Multiplexing on PIO Controller B

PIO Controller B				Application Usage	
I/O Line	Peripheral A	Peripheral B	Reset State	Function	Comments
PB0	TF0	RTS3	I/O		
PB1	TK0	CTS3	I/O		
PB2	TD0	SCK3	I/O		
PB3	RD0	MCDA1	I/O		
PB4	RK0	MCDA2	I/O		
PB5	RF0	MCDA3	I/O		
PB6	TF1	TIOA3	I/O		
PB7	TK1	TIOB3	I/O		
PB8	TD1	TIOA4	I/O		
PB9	RD1	TIOB4	I/O		
PB10	RK1	TIOA5	I/O		
PB11	RF1	TIOB5	I/O		
PB12	TF2	ETX2	I/O		
PB13	TK2	ETX3	I/O		
PB14	TD2	ETXER	I/O		
PB15	RD2	ERX2	I/O		
PB16	RK2	ERX3	I/O		
PB17	RF2	ERXDV	I/O		
PB18	RI1	ECOL	I/O		
PB19	DTR1	ERXCK	I/O		
PB20	TXD1		I/O		
PB21	RXD1		I/O		
PB22	SCK1		I/O		
PB23	DCD1		I/O		
PB24	CTS1		I/O		
PB25	DSR1	EF100	I/O		
PB26	RTS1		I/O		
PB27	PCK0		I/O		
PB28	FIQ		I/O		
PB29	IRQ0		I/O		

### 10.3.3 PIO Controller C Multiplexing

The PIO Controller C has no multiplexing and only peripheral A lines are used. Selecting Peripheral B on the PIO Controller C has no effect.

**Table 10-4.** Multiplexing on PIO Controller C

PIO Controller C				Application Usage	
I/O Line	Peripheral A	Peripheral B	Reset State	Function	Comments
PC0	BCK		I/O		
PC1	BFRDY/SMOE		I/O		
PC2	BFAVD		I/O		
PC3	BFBAA/SMWE		I/O		
PC4	BFOE		I/O		
PC5	BWE		I/O		
PC6	NWAIT		I/O		
PC7	A23		A23		
PC8	A24		A24		
PC9	A25/CFRNW		A25		
PC10	NCS4/CFCS		NCS4		
PC11	NCS5/CFCE1		NCS5		
PC12	NCS6/CFCE2		NCS6		
PC13	NCS7		NCS7		
PC14			I/O		
PC15			I/O		
PC16	D16		I/O		
PC17	D17		I/O		
PC18	D18		I/O		
PC19	D19		I/O		
PC20	D20		I/O		
PC21	D21		I/O		
PC22	D22		I/O		
PC23	D23		I/O		
PC24	D24		I/O		
PC25	D25		I/O		
PC26	D26		I/O		
PC27	D27		I/O		
PC28	D28		I/O		
PC29	D29		I/O		
PC30	D30		I/O		
PC31	D31		I/O		

### 10.3.4 PIO Controller D Multiplexing

The PIO Controller D multiplexes pure output signals on peripheral A connections, in particular from the EMAC MII interface and the ETM Port on the peripheral B connections.

The PIO Controller D is available only in the 256-ball BGA package option of the AT91RM9200.

**Table 10-5.** Multiplexing on PIO Controller D

PIO Controller D				Application Usage	
I/O Line	Peripheral A	Peripheral B	Reset State	Function	Comments
PD0	ETX0		I/O		
PD1	ETX1		I/O		
PD2	ETX2		I/O		
PD3	ETX3		I/O		
PD4	ETXEN		I/O		
PD5	ETXER		I/O		
PD6	DTXD		I/O		
PD7	PCK0	TSYNC	I/O		
PD8	PCK1	TCLK	I/O		
PD9	PCK2	TPS0	I/O		
PD10	PCK3	TPS1	I/O		
PD11		TPS2	I/O		
PD12		TPK0	I/O		
PD13		TPK1	I/O		
PD14		TPK2	I/O		
PD15	TD0	TPK3	I/O		
PD16	TD1	TPK4	I/O		
PD17	TD2	TPK5	I/O		
PD18	NPCS1	TPK6	I/O		
PD19	NPCS2	TPK7	I/O		
PD20	NPCS3	TPK8	I/O		
PD21	RTS0	TPK9	I/O		
PD22	RTS1	TPK10	I/O		
PD23	RTS2	TPK11	I/O		
PD24	RTS3	TPK12	I/O		
PD25	DTR1	TPK13	I/O		
PD26		TPK14	I/O		
PD27		TPK15	I/O		

### 10.3.5 System Interrupt

The System Interrupt is the wired-OR of the interrupt signals coming from:

- the Memory Controller
- the Debug Unit
- the System Timer
- the Real-Time Clock
- the Power Management Controller

The clock of these peripherals cannot be controlled and the Peripheral ID 1 can only be used within the Advanced Interrupt Controller.

### 10.3.6 External Interrupts

All external interrupt signals, i.e., the Fast Interrupt signal FIQ or the Interrupt signals IRQ0 to IRQ6, use a dedicated Peripheral ID. However, there is no clock control associated with these peripheral IDs.

## 10.4 External Bus Interface

- Integrates three External Memory Controllers:
  - Static Memory Controller
  - SDRAM Controller
  - Burst Flash Controller
- Additional logic for NAND Flash/SmartMedia and CompactFlash support
- Optimized External Bus:
  - 16- or 32-bit Data Bus
  - Up to 26-bit Address Bus, up to 64-Mbytes addressable
  - Up to 8 Chip Selects, each reserved to one of the eight Memory Areas
  - Optimized pin multiplexing to reduce latencies on External Memories
- Configurable Chip Select Assignment:
  - Burst Flash Controller or Static Memory Controller on NCS0
  - SDRAM Controller or Static Memory Controller on NCS1
  - Static Memory Controller on NCS3, Optional NAND Flash/SmartMedia Support
  - Static Memory Controller on NCS4 - NCS6, Optional CompactFlash Support
  - Static Memory Controller on NCS7

## 10.5 Static Memory Controller

- External memory mapping, 512-Mbyte address space
- Up to 8 Chip Select Lines
- 8- or 16-bit Data Bus
- Remap of Boot Memory
- Multiple Access Modes supported
  - Byte Write or Byte Select Lines
  - Two different Read Protocols for each Memory Bank
- Multiple device adaptability



- Compliant with LCD Module
- Programmable Setup Time Read/Write
- Programmable Hold Time Read/Write
- Multiple Wait State Management
  - Programmable Wait State Generation
  - External Wait Request
  - Programmable Data Float Time

## 10.6 SDRAM Controller

- Numerous configurations supported
  - 2K, 4K, 8K Row Address Memory Parts
  - SDRAM with two or four Internal Banks
  - SDRAM with 16- or 32-bit Data Path
- Programming facilities
  - Word, half-word, byte access
  - Automatic page break when Memory Boundary has been reached
  - Multibank Ping-pong Access
  - Timing parameters specified by software
  - Automatic refresh operation, refresh rate is programmable
- Energy-saving capabilities
  - Self-refresh and Low-power Modes supported
- Error detection
  - Refresh Error Interrupt
- SDRAM Power-up Initialization by software
- Latency is set to two clocks (CAS Latency of 1, 3 Not Supported)
- Auto Precharge Command not used

## 10.7 Burst Flash Controller

- Multiple Access Modes supported
  - Asynchronous or Burst Mode Byte, Half-word or Word Read Accesses
  - Asynchronous Mode Half-word Write Accesses
- Adaptability to different device speed grades
  - Programmable Burst Flash Clock Rate
  - Programmable Data Access Time
  - Programmable Latency after Output Enable
- Adaptability to different device access protocols and bus interfaces
  - Two Burst Read Protocols: Clock Control Address Advance or Signal Controlled Address Advance
  - Multiplexed or separate address and data buses
  - Continuous Burst and Page Mode Accesses supported

## 10.8 Peripheral DMA Controller (PDC)

- Generates transfers to/from peripherals such as DBGU, USART, SSC, SPI and MCI
- Twenty channels
- One Master Clock cycle needed for a transfer from memory to peripheral
- Two Master Clock cycles needed for a transfer from peripheral to memory

## 10.9 System Timer

- One Period Interval Timer, 16-bit programmable counter
- One Watchdog Timer, 16-bit programmable counter
- One Real-time Timer, 20-bit free-running counter
- Interrupt Generation on event

## 10.10 Real-time Clock

- Low power consumption
- Full asynchronous design
- Two hundred year calendar
- Programmable Periodic Interrupt
- Alarm and update parallel load
- Control of alarm and update Time/Calendar Data In

## 10.11 USB Host Port

- Compliance with Open HCI Rev 1.0 specification
- Compliance with USB V2.0 Full-speed and Low-speed Specification
- Supports both Low-speed 1.5 Mbps and Full-speed 12 Mbps USB devices
- Root hub integrated with two downstream USB ports
- Two embedded USB transceivers
- Supports power management
- Operates as a master on the Memory Controller

## 10.12 USB Device Port

- USB V2.0 full-speed compliant, 12 Mbits per second
- Embedded USB V2.0 full-speed transceiver
- Embedded dual-port RAM for endpoints
- Suspend/Resume logic
- Ping-pong mode (two memory banks) for isochronous and bulk endpoints
- Six general-purpose endpoints
  - Endpoint 0, Endpoint 3: 8 bytes, no ping-pong mode
  - Endpoint 1, Endpoint 2: 64 bytes, ping-pong mode
  - Endpoint 4, Endpoint 5: 256 bytes, ping-pong mode

## 10.13 Ethernet MAC

- Compatibility with IEEE Standard 802.3

- 10 and 100 Mbits per second data throughput capability
- Full- and half-duplex operation
- MII or RMII interface to the physical layer
- Register interface to address, status and control registers
- DMA interface, operating as a master on the Memory Controller
- Interrupt generation to signal receive and transmit completion
- 28-byte transmit and 28-byte receive FIFOs
- Automatic pad and CRC generation on transmitted frames
- Address checking logic to recognize four 48-bit addresses
- Supports promiscuous mode where all valid frames are copied to memory
- Supports physical layer management through MDIO interface

### 10.14 Serial Peripheral Interface

- Supports communication with serial external devices
  - Four chip selects with external decoder support allow communication with up to 15 peripherals
  - Serial memories, such as DataFlash and 3-wire EEPROMs
  - Serial peripherals, such as ADCs, DACs, LCD Controllers, CAN Controllers and Sensors
  - External co-processors
- Master or slave serial peripheral bus interface
  - 8- to 16-bit programmable data length per chip select
  - Programmable phase and polarity per chip select
  - Programmable transfer delays between consecutive transfers and between clock and data per chip select
  - Programmable delay between consecutive transfers
  - Selectable mode fault detection
- Connection to PDC channel optimizes data transfers
  - One channel for the receiver, one channel for the transmitter
  - Next buffer support

### 10.15 Two-wire Interface

- Compatibility with standard two-wire serial memory
- One, two or three bytes for slave address
- Sequential Read/Write operations

### 10.16 USART

- Programmable Baud Rate Generator
- 5- to 9-bit full-duplex synchronous or asynchronous serial communications
  - 1, 1.5 or 2 stop bits in Asynchronous Mode or 1 or 2 stop bits in Synchronous Mode
  - Parity generation and error detection
  - Framing error detection, overrun error detection

- MSB- or LSB-first
- Optional break generation and detection
- By 8 or by-16 over-sampling receiver frequency
- Optional hardware handshaking RTS-CTS
- Optional modem signal management DTR-DSR-DCD-RI
- Receiver time-out and transmitter timeguard
- Optional Multi-drop Mode with address generation and detection
- RS485 with driver control signal
- ISO7816, T = 0 or T = 1 Protocols for interfacing with smart cards
  - NACK handling, error counter with repetition and iteration limit
- IrDA modulation and demodulation
  - Communication at up to 115.2 Kbps
- Test Modes
  - Remote Loopback, Local Loopback, Automatic Echo
- Connection of two Peripheral DMA Controller (PDC) channels
  - Offers buffer transfer without processor intervention

The USART describes features allowing management of the Modem Signals DTR, DSR, DCD and RI. For details, see ["Modem Mode" on page 435](#).

In the AT91RM9200, only the USART1 implements these signals, named DTR1, DSR1, DCD1 and RI1.

The USART0, USART2 and USART3 do not implement all the modem signals. Only RTS and CTS (RTS0 and CTS0, RTS2 and CTS2, RTS3 and CTS3, respectively) are implemented in these USARTs for other features.

Thus, programming the USART0, USART2 or the USART3 in Modem Mode may lead to unpredictable results. In these USARTs, the commands relating to the Modem Mode have no effect and the status bits relating the status of the modem signals are never activated.

## 10.17 Serial Synchronous Controller

- Provides serial synchronous communication links used in audio and telecom applications
- Contains an independent receiver and transmitter and a common clock divider
- Interfaced with two PDC channels to reduce processor overhead
- Offers a configurable frame sync and data length
- Receiver and transmitter can be programmed to start automatically or on detection of different event on the frame sync signal
- Receiver and transmitter include a data signal, a clock signal and a frame synchronization signal

## 10.18 Timer Counter

- Three 16-bit Timer Counter Channels
- Wide range of functions including:
  - Frequency Measurement
  - Event Counting

- Interval Measurement
- Pulse Generation
- Delay Timing
- Pulse Width Modulation
- Up/down Capabilities
- Each channel is user-configurable and contains:
  - Three external clock inputs
  - Five internal clock inputs
  - Two multi-purpose input/output signals
- Internal interrupt signal
- Two global registers that act on all three TC Channels
- The Timer Counter 0 to 5 are described with five generic clock inputs, TIMER\_CLOCK1 to TIMER\_CLOCK5. In the AT91RM9200, these clock inputs are connected to the Master Clock (MCK), to the Slow Clock (SLCK) and to divisions of the Master Clock. For details, see ["Clock Control" on page 488](#).  
[Table 10-6](#) gives the correspondence between the Timer Counter clock inputs and clocks in the AT91RM9200. Each Timer Counter 0 to 5 displays the same configuration.

**Table 10-6.** Timer Counter Clocks Assignment

TC Clock Input	Clock
TIMER_CLOCK1	MCK/2
TIMER_CLOCK2	MCK/8
TIMER_CLOCK3	MCK/32
TIMER_CLOCK4	MCK/128
TIMER_CLOCK5	SLCK

## 10.19 MultiMedia Card Interface

- Compatibility with MultiMedia Card Specification Version 2.2
- Compatibility with SD Memory Card Specification Version 1.0
- Cards clock rate up to Master Clock divided by 2
- Embedded power management to slow down clock rate when not used
- Supports two slots
  - One slot for one MultiMedia Card bus (up to 30 cards) or one SD Memory Card
- Support for stream, block and multi-block data read and write
- Connection to a Peripheral DMA Controller (PDC) channel
  - Minimizes processor intervention for large buffer transfers

## 11. Package Drawings

Figure 11-1. 208-lead PQFP Package Drawing

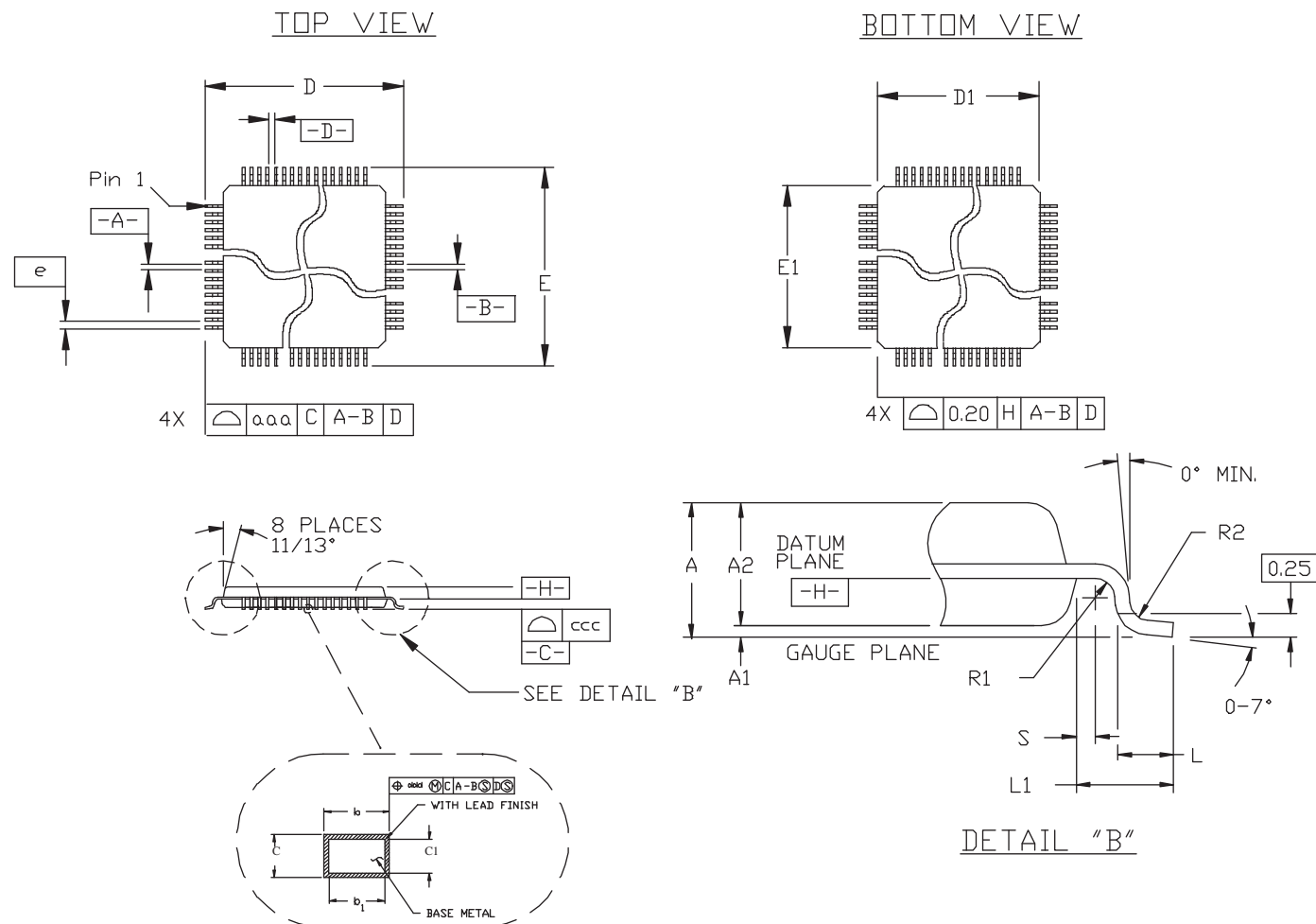
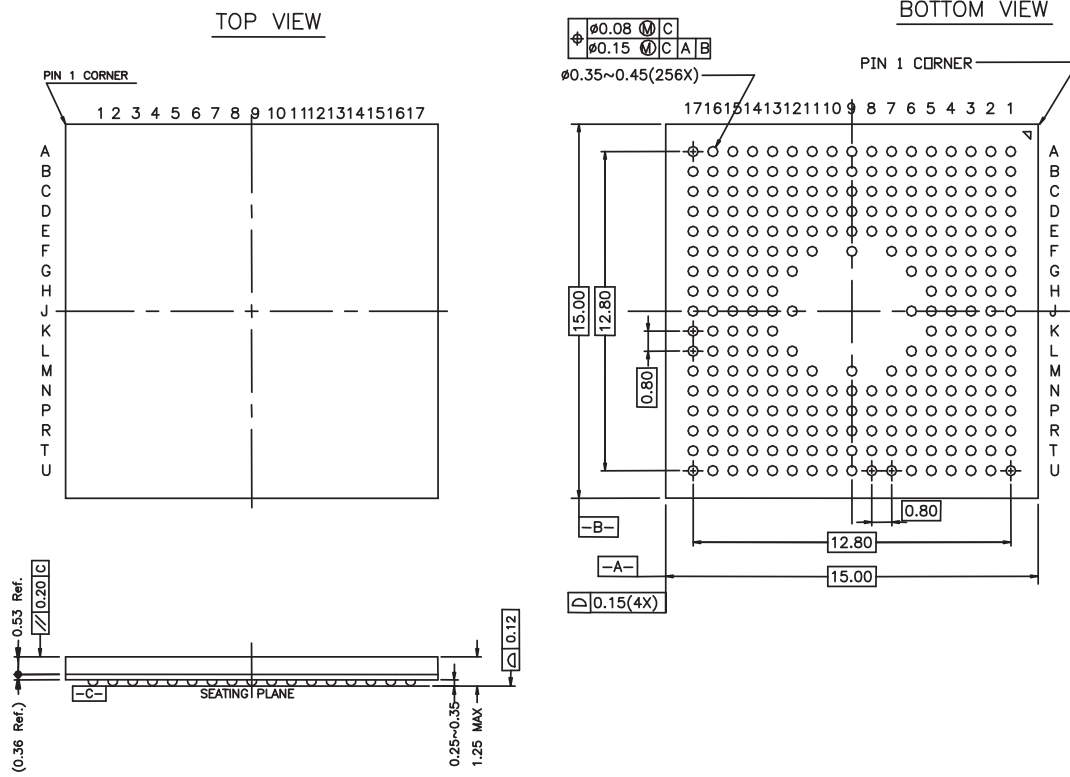

Table 11-1. 208-lead PQFP Package Dimensions (in mm)

Symbol	Min	Nom	Max	Symbol	Min	Nom	Max
c	0.11		0.23	b1	0.17	0.20	0.23
c1	0.11	0.15	0.19	ddd	0.10		
L	0.65	0.88	1.03	<b>Tolerances of Form and Position</b>			
L1	1.60 REF			aaa		0.25	
R2	0.13		0.3	ccc			0.1
R1	0.13			<b>BSC</b>			
S	0.4			D		31.20	
A	4.10			D1		28.00	
A1	0.25		0.50	E		31.20	
A2	3.20	3.40	3.60	E1		28.00	
b	0.17		0.27	e		0.50	

Figure 11-2. 256-ball BGA Package Drawing



## 12. AT91RM9200 Ordering Information

**Table 12-1.** Ordering Information

Ordering Code	Package	Package Type	Temperature Operating Range
AT91RM9200-QU-002	PQFP 208	Green	Industrial (-40· C to 85· C)
AT91RM9200-CJ-002	BGA 256	RoHS-compliant	

## 13. Revision History

Doc. Rev	Source	Comments
Lit°1768A		• <b>Date Qualified:</b> May 2001
Lit°1768B		• <b>Date Qualified:</b> September 2001
Lit°1768C		• <b>Date Qualified:</b> November 2001
Lit°1768D		• <b>Date Qualified:</b> 5 Mar-02
Lit°1768E		• <b>Date Qualified:</b> 12-Jul-02
Lit°1768F		• <b>Date Qualified:</b> 5 Feb-03
Doc. Rev	Source	Comments
1768GS	Review	• <b>Date Qualified:</b> 04-Sep-03
		• Page 2; Added Description.
		• Page 3; Updated Figure 1, Block Diagram, remove reference to Multi-master Memory Controller.
		• Page 4; Added section Key Features. Updated all descriptions of key blocks
		• Page 17; Added text to section Peripheral Multiplexing on PIO Lines.
		• Page 18; Expanded Table 3, Multiplexing on PIO Controller A.
		• Page 19; Expanded Table 4, Multiplexing on PIO Controller B.
		• Page 20; Expanded Table 5, Multiplexing on PIO Controller C.
		• Page 21; Expanded Table 6, Multiplexing on PIO Controller D.
		• Page 27; Updated Table 8, Peripheral Identifiers, Peripheral ID 1 description.
		• Page 28; Added section Product Memory Mapping.
		• Page 30; Updated and corrected Figure 6, System Peripherals Mapping.
• Page 31; Updated and corrected Figure 7, User Peripherals Mapping.		
Doc. Rev	Source	Comments
1768HS	CSRs/Review	• <b>Date Qualified:</b> Unqualified/Internal on Intranet 27-Jan-05
		• Global; Reformat in Corporate Template.
		• Global; Peripheral Data Controller (PDC) renamed Peripheral DMA Controller.
	CSR 04-066	• Page 1; Features: USART Hardware Handshaking. Software Handshaking removed.
	CSR 03-209	• Page 3; Figure 1: NWAIT pin added to block diagram.
	CSR 03-244	• Page 14; Table 1. AT91RM9200 Pinout for 208-lead PQFP package, pins 28, 30, 37 and 39 names changed
	CSR 04-315	• Page 23; Table 7. Pin Description, ICE and JTAG description, "Internal Pullup" added to comments for all signals, except TDO.
CSR 03-209	• Page 24; Table 7. Pin Description, NWAIT pin added.	
Doc. Rev	Source	Comments
1768IS		Corrected power consumption values on page 1.
	CSR 05-348	In <a href="#">Table 4-7, "Pin Description List,"</a> on <a href="#">page 24</a> added mention of Schmitt trigger for pins JTAGESEL, TDI, TCK, TMS, NTRST, TST0, TST1 and NRST.

## Revision History (cont.)

Document Ref.	Comments	Change Request Ref.
1768JS	Reformatted <a href="#">Section 8. "Memories"</a> on page 17. Inserted new figure <a href="#">Figure 8-1 on page 17</a> with overall product memory map.	
	Added <a href="#">Section 11. "Package Drawings"</a> on page 33.	
1768KS	Updated <a href="#">"Features"</a> and <a href="#">Section 4. "Package and Pinout"</a> on page 8 with additional details on package options.	
	Updated <a href="#">Table 40-1, "Ordering Information,"</a> on page 661.	
1768LS	Ordering code AT91RM9200-CI-002 removed from <a href="#">Section 12. "AT91RM9200 Ordering Information"</a> on page 35	6423
1768MS	USART3 0XFFECC000 changed into 0XFFFCC000 in <a href="#">Figure 8-1 on page 17</a>	5067









## Headquarters

---

**Atmel Corporation**  
2325 Orchard Parkway  
San Jose, CA 95131  
USA  
Tel: 1(408) 441-0311  
Fax: 1(408) 487-2600

## International

---

**Atmel Asia**  
Unit 1-5 & 16, 19/F  
BEA Tower, Millennium City 5  
418 Kwun Tong Road  
Kwun Tong, Kowloon  
Hong Kong  
Tel: (852) 2245-6100  
Fax: (852) 2722-1369

**Atmel Europe**  
Le Krebs  
8, Rue Jean-Pierre Timbaud  
BP 309  
78054 Saint-Quentin-en-  
Yvelines Cedex  
France  
Tel: (33) 1-30-60-70-00  
Fax: (33) 1-30-60-71-11

**Atmel Japan**  
9F, Tonetsu Shinkawa Bldg.  
1-24-8 Shinkawa  
Chuo-ku, Tokyo 104-0033  
Japan  
Tel: (81) 3-3523-3551  
Fax: (81) 3-3523-7581

## Product Contact

---

**Web Site**  
[www.atmel.com](http://www.atmel.com)  
[www.atmel.com/AT91SAM](http://www.atmel.com/AT91SAM)

**Technical Support**  
[AT91SAM Support](mailto:AT91SAM_Support@atmel.com)  
[Atmel techincal support](mailto:Atmel_techincal_support@atmel.com)

**Sales Contacts**  
[www.atmel.com/contacts/](http://www.atmel.com/contacts/)

**Literature Requests**  
[www.atmel.com/literature](http://www.atmel.com/literature)

---

**Disclaimer:** The information in this document is provided in connection with Atmel products. No license, express or implied, by estoppel or otherwise, to any intellectual property right is granted by this document or in connection with the sale of Atmel products. **EXCEPT AS SET FORTH IN ATMEL'S TERMS AND CONDITIONS OF SALE LOCATED ON ATMEL'S WEB SITE, ATMEL ASSUMES NO LIABILITY WHATSOEVER AND DISCLAIMS ANY EXPRESS, IMPLIED OR STATUTORY WARRANTY RELATING TO ITS PRODUCTS INCLUDING, BUT NOT LIMITED TO, THE IMPLIED WARRANTY OF MERCHANTABILITY, FITNESS FOR A PARTICULAR PURPOSE, OR NON-INFRINGEMENT. IN NO EVENT SHALL ATMEL BE LIABLE FOR ANY DIRECT, INDIRECT, CONSEQUENTIAL, PUNITIVE, SPECIAL OR INCIDENTAL DAMAGES (INCLUDING, WITHOUT LIMITATION, DAMAGES FOR LOSS OF PROFITS, BUSINESS INTERRUPTION, OR LOSS OF INFORMATION) ARISING OUT OF THE USE OR INABILITY TO USE THIS DOCUMENT, EVEN IF ATMEL HAS BEEN ADVISED OF THE POSSIBILITY OF SUCH DAMAGES.** Atmel makes no representations or warranties with respect to the accuracy or completeness of the contents of this document and reserves the right to make changes to specifications and product descriptions at any time without notice. Atmel does not make any commitment to update the information contained herein. Unless specifically provided otherwise, Atmel products are not suitable for, and shall not be used in, automotive applications. Atmel's products are not intended, authorized, or warranted for use as components in applications intended to support or sustain life.



© 2009 Atmel Corporation. All rights reserved. Atmel®, Atmel logo and combinations thereof DataFlash® and others, are registered trademarks or trademarks of Atmel Corporation or its subsidiaries. ARM®, Thumb® and the ARMPowered® logo and others are registered trademarks or trademarks ARM Ltd. Other terms and product names may be trademarks of others.

## Looking for pricing, stock, or lifecycle information?

Click below to explore more details on WIN SOURCE:

 [View AT91RM9200-QU-002 on WIN SOURCE](#)

 [Atmel Information](#)

## Optimize Your Supply Chain with WIN SOURCE Solutions

-  Global Sourcing Solution
-  Obsolete Management
-  Cost Control Management
-  Shortage Management
-  Alternative Solution
-  Excess Inventory Management