



**THE DATASHEET OF  
SP485RCP-L**



## 1/10th Unit Load RS-485 Transceiver

### FEATURES

- Allows Over 400 Transceivers On A Transmission Line (1/10th Unit Load)
- High Impedance on Receiver Inputs ( $R_{IN} = 150k\Omega$  typical)
- Half-Duplex Configuration Consistent With Industry Standard Pinout
- -7V to +12V Common Mode Input Voltage Range
- Low Power Consumption (250mW)
- Separate Driver and Receiver Enable

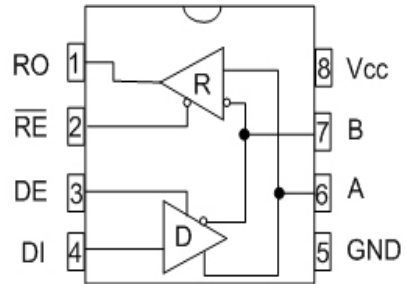

SP485R  
Pinout (Top View)

### DESCRIPTION

The **SP485R** is a pin-to-pin equivalent to our existing SP485 product and offers a high receiver input impedance. The higher receiver input impedance allows for connecting over 400 transceivers on a single transmission line without degrading the RS-485 driver signal. The device is packaged in a 8-pin plastic DIP or 8-pin narrow SOIC.

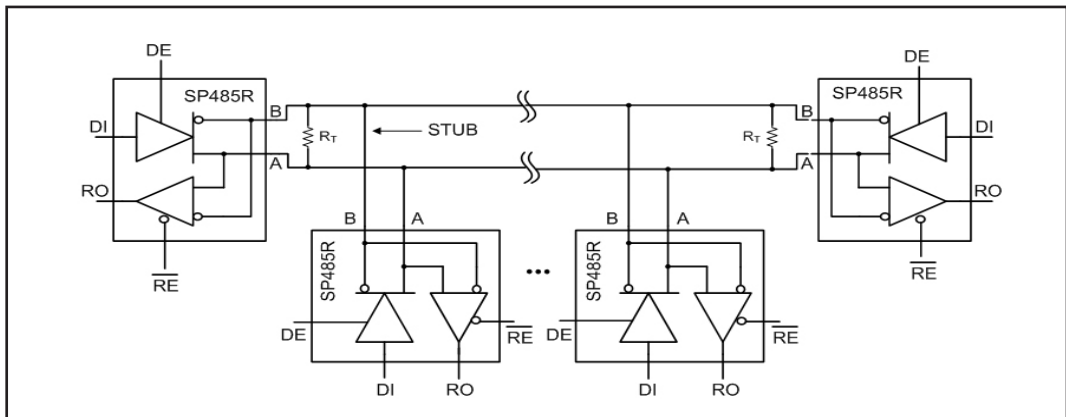

Figure 1. Typical Application Circuit

## ABSOLUTE MAXIMUM RATINGS

These are stress ratings only and functional operation of the device at these ratings or any other above those indicated in the operation sections of the specifications below is not implied. Exposure to absolute maximum rating conditions for extended periods of time may affect reliability.

$V_{CC}$ .....+7V  
Storage Temperature.....-65°C to +150°C

Power Dissipation

8-pin NSOIC.....1000mW  
( $\theta_{JA} = 62^{\circ}\text{C/W}$ )

8-pin PDIP.....1000mW  
( $\theta_{JA} = 62^{\circ}\text{C/W}$ )

## ELECTRICAL CHARACTERISTICS

Typically 25°C @  $V_{CC} = +5V$  unless otherwise noted.

PARAMETERS	MIN.	TYP.	MAX.	UNITS	CONDITIONS
<b>LOGIC INPUTS</b>					
$V_{IL}$			0.8	Volts	
$V_{IH}$	2.0			Volts	
<b>LOGIC OUTPUTS</b>					
$V_{OL}$			0.4	Volts	$I_{OUT} = -3.2\text{mA}$
$V_{OH}$	2.4			Volts	$I_{OUT} = 1.0\text{mA}$
<b>RS-485 DRIVER DC Characteristics</b>					
Open Circuit Voltage			6.0	Volts	
Differential Output Voltage	1.5		5.0	Volts	$R_L = 54\Omega, C_L = 50\text{pF}$
Balance			+/-0.2	Volts	$ V_T  -  \overline{V_T} $
Common-Mode Output			3.0	Volts	
Output Current	28.0			mA	$R_L = 54\Omega$
Short Circuit Current			+/-250	mA	Terminated in -7V to +12V
<b>RS-485 DRIVER AC Characteristics</b>					
Maximum Data Rate	5			Mbps	$R_L = 54\Omega,$
Output Transition Time		30		ns	Rise/fall time, 10% to 90%
Propagation Delay, $t_{PLH}$		60	100	ns	See Figures 4 & 6, $R_{DIFF} = 54\Omega,$ $C_{L1} = C_{L2} = 100\text{pF}$
Propagation Delay, $t_{PHL}$		60	100	ns	See Figures 4 & 6, $R_{DIFF} = 54\Omega,$ $C_{L1} = C_{L2} = 100\text{pF}$
Driver Output Skew		5	15	ns	see Figures 4 and 6, $t_{SKEW} =  t_{DPHL} - t_{DPLH} $
<b>RS-485 RECEIVER DC Characteristics</b>					
Output Voltage Low, $V_{OL}$			0.4	Volts	
Output Voltage High, $V_{OH}$	2.4			Volts	
Tri-State Output Current			+/-1	$\mu\text{A}$	$0.4V \leq V_{OUT} \leq 2.4V; \overline{RE} = V_{CC}$

## ELECTRICAL CHARACTERISTICS

Typically 25°C @  $V_{CC} = +5V$  unless otherwise noted.

PARAMETERS	MIN.	TYP.	MAX.	UNITS	CONDITIONS
<b>RS-485 RECEIVER DC Characteristics (continued)</b>					
Common Mode Range	-7.0		+12.0	Volts	
Receiver Sensitivity			+/-0.2	Volts	$-7V \leq V_{CM} \leq +12V$
Input Impedance	120	150		kΩ	$-7V \leq V_{CM} \leq +12V$
<b>RS-485 RECEIVER AC Characteristics</b>					
Maximum Data Rate	1			Mbps	
Propagation Delay; $t_{PHL}$			1200	ns	See Figures 4 & 8, $R_{DIFF} = 54\Omega$ , $C_{L1} = C_{L2} = 100pF$
Propagation Delay; $t_{PLH}$			1200	ns	See Figures 4 & 8, $R_{DIFF} = 54\Omega$ , $C_{L1} = C_{L2} = 100pF$
Differential Receiver Skew		60		ns	See Figures 4 & 8, $R_{DIFF} = 54\Omega$ , $C_{L1} = C_{L2} = 100pF$ , $t_{SKEW} =  t_{PHL} - t_{PLH} $
<b>RS-485 DRIVER Enable / Disable Time</b>					
Driver Enable to Output Low		40	500	ns	$C_L = 15pF$ , see Figures 5 and 7, $S_1$ closed
Driver Enable to Output High		40	500	ns	$C_L = 15pF$ , see Figures 5 and 7, $S_2$ closed
Driver Disable Time from Low		40	500	ns	$C_L = 15pF$ , see Figures 5 and 7, $S_1$ closed
Driver Disable Time from High		40	500	ns	$C_L = 15pF$ , see Figures 5 and 7, $S_2$ closed
<b>RS-485 RECEIVER Enable / Disable Time</b>					
Receiver Enable to Output Low		40	500	ns	$C_L = 15pF$ , see Figures 3 and 9, $S_1$ closed
Receiver Enable to Output High		40	500	ns	$C_L = 15pF$ , see Figures 3 and 9, $S_2$ closed
Receiver Disable from Low		40	500	ns	$C_L = 15pF$ , see Figures 3 and 9, $S_1$ closed
Receiver Disable from High		40	500	ns	$C_L = 15pF$ , see Figures 3 and 9, $S_1$ closed
<b>POWER REQUIREMENTS</b>					
Supply Voltage $V_{CC}$	+4.75		+5.25	Volts	
Supply Current $I_{CC}$ , No Load		300	500	μA	$\overline{RE} = V_{CC}$ or 0V, DE = 0V
Supply Current $I_{CC}$ , No Load		500	900	μA	$\overline{RE} = V_{CC}$ or 0V, DE = VCC
<b>ENVIRONMENTAL</b>					
Operating Temperature					
Commercial (...C..)	0		+70	°C	
Industrial (...E..)	-40		+85	°C	
Storage Temperature	-65		+150	°C	

## PIN FUNCTION

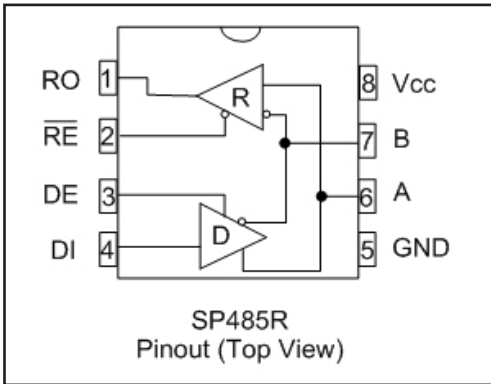

- Pin 1 - RO - Receiver Output
- Pin 2 -  $\overline{RE}$  - Receiver Output Enable Active LOW
- Pin 3 - DE - Driver Output Enable Active HIGH
- Pin 4 DI - Driver Input
- Pin 5 - GND - Ground Connection
- Pin 6 - A - Driver Output / Receiver input Non-Inverting
- Pin 7 - B - Driver Output / Receiver Input Inverting
- Pin 8 - Vcc - Positive Supply  $4.75V \leq V_{CC} \leq 5.25V$

## RECEIVER INPUT GRAPH

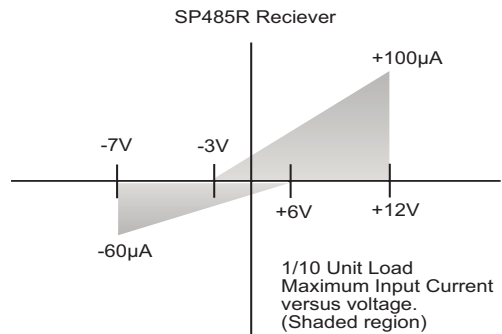
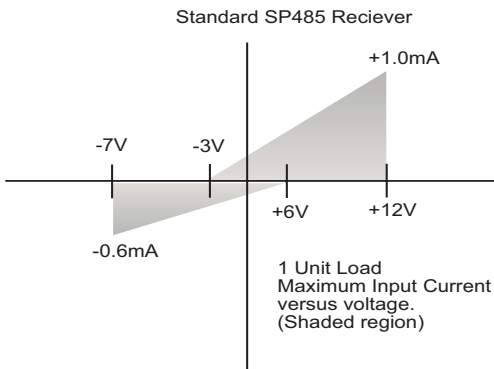

## TEST CIRCUITS

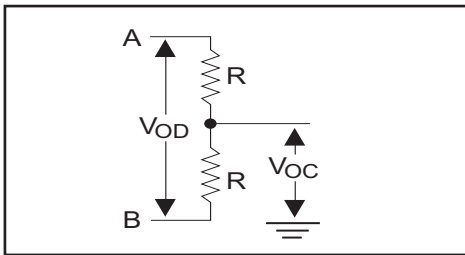

Figure 2. Driver DC Test Load Circuit

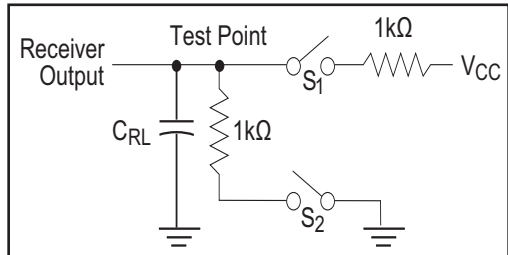

Figure 3. Receiver Timing Test Load Circuit

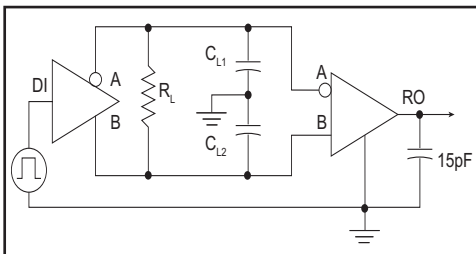

Figure 4. RS-485 Driver/Receiver Timing Test

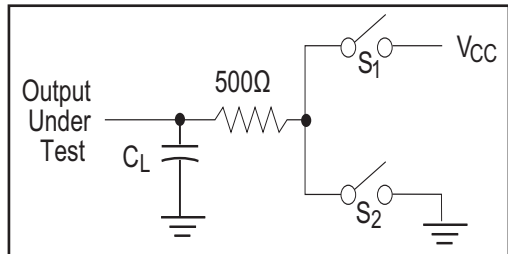

Figure 5. Driver Timing Test Load #2 Circuit

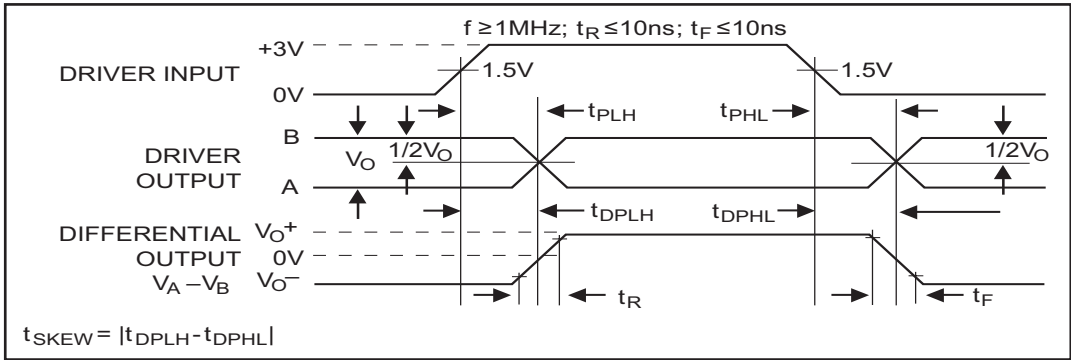

Figure 6. Driver Propagation Delays

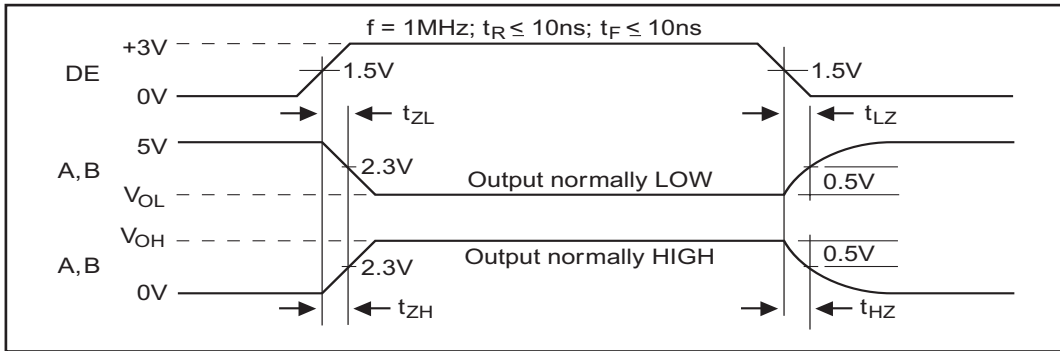

Figure 7. Driver Enable and Disable Times

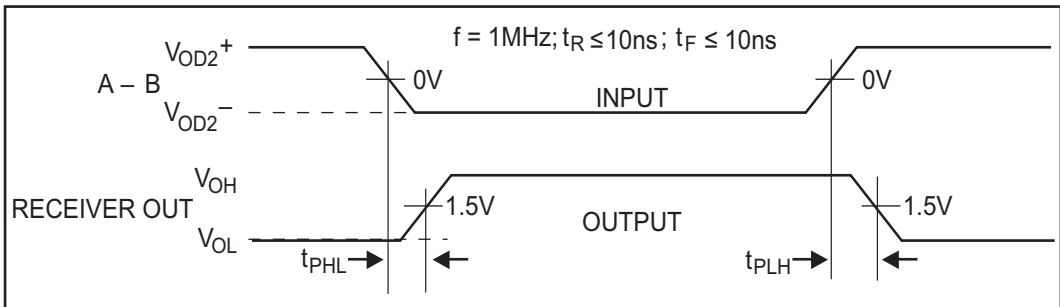

Figure 8. Receiver Propagation Delays

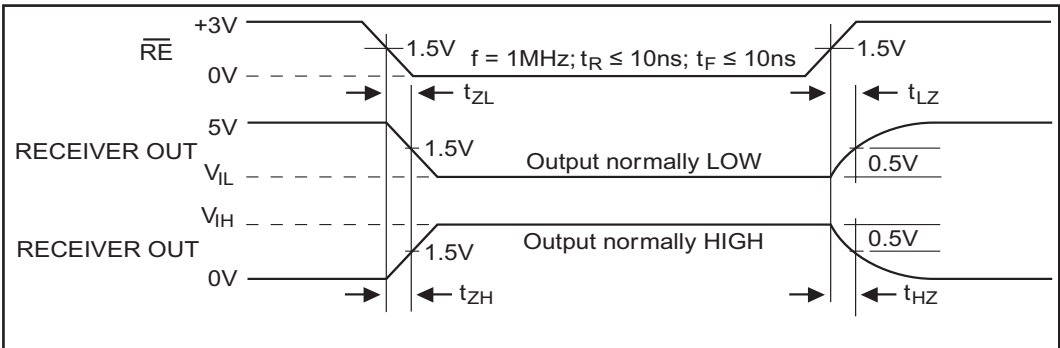

Figure 9. Receiver Enable and Disable Times

The **SP485R** is a low power RS-485 differential transceiver. Similar to the SP485, the **SP485R** contains a half-duplex driver and receiver with tri-state control. However, the **SP485R** is intended for increased connections on a single bus compared to the original RS-485 specification.

The RS-485 standard is ideal for multi-drop applications where one bus can contain many drivers and/or receivers. The RS-485 standard implementation allows up to 32 transceivers to be connected on to the data bus. RS-485 is also specified for driving higher speeds over long cable lengths of up to 4000 feet. The **SP485R** exceeds the standard by allowing up to 400 receivers to share the bus.

## DRIVERS

The driver output complies with the RS-485 electrical characteristics as specified by the standard. The output swings from 0V to  $V_{cc}$  and maintains greater than +1.5V with a 54 $\Omega$  load attached between the two outputs. In adhering to the RS-485 specification, the driver outputs inherently comply with the RS-422 standard. With a load of 100 $\Omega$  between the two outputs, the driver can sustain at least +2.0V.

The driver contains an enable pin (DE) which tri-states the output when DE is logic LOW. The outputs during the tri-state condition are at high impedance (>100k $\Omega$ ). A logic HIGH enables the driver for normal operation. The driver can operate to at least 5Mbps.

## RECEIVERS

The **SP485R** receiver has differential inputs with an input sensitivity of lower than  $\pm 200$ mV. As mentioned above, the RS-485 specification allows up to 32 transceivers on the same bus. The **SP485R** allows over 400 transceivers on the same bus due to its high impedance of at least 120k $\Omega$ . This higher capacity allows more components to be attached to the same bus without degrading the signal quality. The drivers are still able to drive an equivalent 54 $\Omega$  from the 320

transceivers with an input impedance of at least 120k $\Omega$  in parallel along with the two 125 $\Omega$  cable termination resistors on each end.

The receiver contains an enable pin ( $\overline{RE}$ ) which enables the receiver when a logic LOW is asserted. A logic HIGH will tri-state the receiver output and the inputs will maintain at least 120k $\Omega$  impedance. The receiver can operate to at least 1Mbps.

The receiver also contains a fail-safe feature which outputs a logic HIGH when the inputs are open as in a disconnected cable.

REVISION HISTORY			
REV	DESCRIPTION	DATE	APP'D
A	DRAWING ORIGINATOR	08/16/05	JL
B	DRAWING FORMAT MODIFICATION	07/19/06	JL
C	CHANGE DRAWING LOGO AND COMPANY NAME	11/16/07	JL

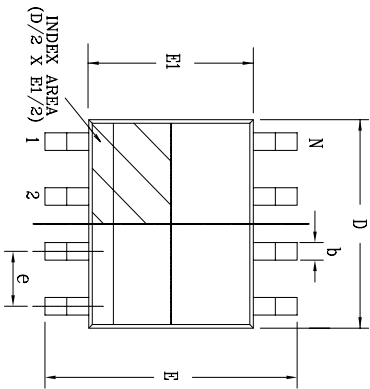

Top View

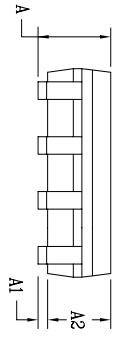

Side View

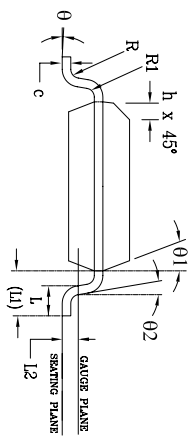

Front View

8 Pin SOICN JEDEC MS-012 Variation AA		DIMENSIONS IN MM (Control Unit)				DIMENSIONS IN INCH (Reference Unit)			
SYMBOLS		MIN	NOM	MAX	MIN	NOM	MAX		
A	1.35	—	1.75	0.053	—	0.069	—		
A1	0.10	—	0.25	0.004	—	0.010	—		
A2	1.25	—	1.65	0.049	—	0.065	—		
b	0.31	—	0.51	0.012	—	0.020	—		
c	0.17	—	0.25	0.007	—	0.010	—		
E	6.00 BSC	—	—	0.236 BSC	—	—	—		
E1	3.90 BSC	—	—	0.154 BSC	—	—	—		
e	1.27 BSC	—	—	0.050 BSC	—	—	—		
h	0.25	—	0.50	0.010	—	0.020	—		
L	0.40	—	1.27	0.016	—	0.050	—		
L1	1.04 REF	—	—	0.041 REF	—	—	—		
L2	0.25 BSC	—	—	0.010 BSC	—	—	—		
R	0.07	—	—	0.003	—	—	—		
R1	0.07	—	—	0.003	—	—	—		
0	0°	—	—	8°	—	—	—		
01	5°	—	—	15°	—	—	—		
02	0°	—	—	0°	—	—	—		
D	4.90 BSC	—	—	0.193 BSC	—	—	—		
N	8	—	—	8	—	—	—		

		<b>EXAR CORPORATION</b> EXAR CORPORATION Fremont, CA 94538	
Drawing No.: 8 PIN SOICN PACKAGE OUTLINE		Revision: C	
8 PIN SOICN PACKAGE OUTLINE		Sheet: 1 OF 1	

REVISION HISTORY				
REV.	DESCRIPTION	DATE	APP'D	
A	DRAWING ORIGINATION	04/26/06	JL	
B	CHANGE DRAWING LOGO AND COMPANY NAME	11/28/07	JL	

REMARKS:  
FOR 8LD AND 16LD  
ALL END LEADS (4X)  
ARE HALF LEAD TYPES

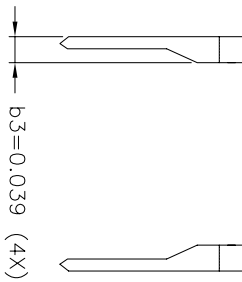
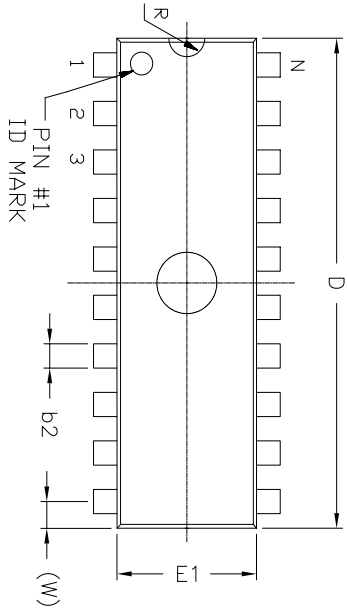

Top View

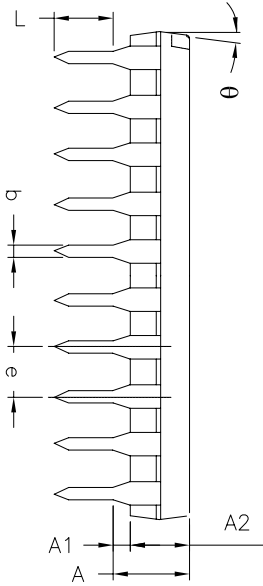

Side View

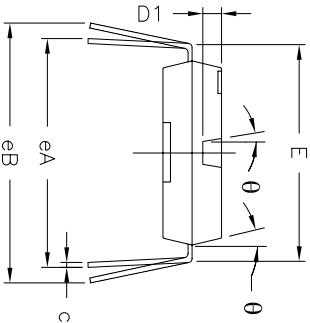

Front View

8 Pin PDIP JEDEC MS-001 Variation BA										
SYMBOLS	DIMENSIONS IN INCH (Control Unit)					DIMENSIONS IN MM (Reference Unit)				
	MIN	NOM	MAX	MIN	NOM	MAX				
A	—	—	0.210	—	—	5.33				
A1	0.015	—	—	0.38	—	—				
A2	0.115	0.130	0.195	2.92	3.30	4.95				
b	0.014	0.018	0.022	0.36	0.46	0.56				
b2	0.045	0.060	0.070	1.14	1.52	1.78				
c	0.008	0.010	0.014	0.20	0.25	0.36				
D1	0.030	—	0.060	0.76	—	1.52				
E	0.300	0.310	0.325	7.62	7.87	8.26				
E1	0.240	0.250	0.280	6.10	6.35	7.11				
e	0.100 BSC					2.54 BSC				
eA	0.300 BSC					7.62 BSC				
eB	—	—	0.430	—	—	10.92				
L	0.115	0.130	0.150	2.92	3.30	3.81				
W	0.075 REF					1.91 REF				
R	0.030 BSC					0.76 BSC				
theta	4°	7°	10°	4°	7°	10°				
D	0.355	0.365	0.400	9.02	9.27	10.16				
N	8					8				

		<b>EXAR CORPORATION</b> Packaging Approval:	
By: JL	Date: 11/28/07	Revision: B	Sheet: 1 OF 1

## ORDERING INFORMATION

Model	Temperature Range	Package Types
SP485RCN-L.....	0°C to +70°C.....	8-pin NSOIC
SP485RCN-L/TR.....	0°C to +70°C.....	8-pin NSOIC
SP485RCP-L.....	0°C to +70°C.....	8-pin PDIP
SP485REN-L.....	-40°C to +85°C.....	8-pin NSOIC
SP485REN-L/TR.....	-40°C to +85°C.....	8-pin NSOIC
SP485REP-L.....	-40°C to +85°C.....	8-pin PDIP

Note: /TR = Tape and Reel

## REVISION HISTORY

DATE	REVISION	DESCRIPTION
06/21/04	--	Legacy Sipex Datasheet
07/23/09	1.0.0	Convert to Exar Format. Update ordering information as a result of discontinued Lead type package options per PDN 081126-01. Remove all reference to the discontinued SP481R.

### Notice

EXAR Corporation reserves the right to make changes to any products contained in this publication in order to improve design, performance or reliability. EXAR Corporation assumes no representation that the circuits are free of patent infringement. Charts and schedules contained herein are only for illustration purposes and may vary depending upon a user's specific application. While the information in this publication has been carefully checked; no responsibility, however, is assumed for inaccuracies.

EXAR Corporation does not recommend the use of any of its products in life support applications where the failure or malfunction of the product can reasonably be expected to cause failure of the life support system or to significantly affect its safety or effectiveness. Products are not authorized for use in such applications unless EXAR Corporation receives, in writing, assurances to its satisfaction that: (a) the risk of injury or damage has been minimized ; (b) the user assumes all such risks; (c) potential liability of EXAR Corporation is adequately protected under the circumstances.

Copyright 2009 EXAR Corporation



Datasheet July 2009

Send your Interface technical inquiry with technical details to: [uarttechsupport@exar.com](mailto:uarttechsupport@exar.com)







Reproduction, in part or whole, without the prior written consent of EXAR Corporation is prohibited.

## Looking for pricing, stock, or lifecycle information?

Click below to explore more details on WIN SOURCE:

-  [View SP485RCP-L on WIN SOURCE](#)
-  [Exar Corporation Information](#)

## Optimize Your Supply Chain with WIN SOURCE Solutions

-  Global Sourcing Solution
-  Obsolete Management
-  Cost Control Management
-  Shortage Management
-  Alternative Solution
-  Excess Inventory Management