













**THE DATASHEET OF
0218010.MXP**



218 Series, 5x20 mm, Time-Lag Fuse



Agency Approvals

Agency	Agency File Number	Ampere Range
	Cartridge: NBK090205-E10480A NBK120802-E10480C	1A – 5A 6.3A – 15A
	Leaded: NBK090205-E10480B NBK120802-E10480D	1A – 5A 6.3A – 15A
	2005010207145715	0.032A – 6.3A
	SU05001-3005 SU05001-2008 SU05001-2009	0.032A – 0.040A 0.050A – 0.800A 1A – 10A
	E10480	0.032A – 16A
	29862	0.032A - 10A; 15A
	1620064	0.032A – 6.3A
	40013496	0.032A – 10A
	40016604	15A*
	KM41462	0.080A – 6.3A
	N/A	0.032A – 16A

* Approval for Cartridge versions only

Description

The 218 series fuse is a 5x20mm time-lag glass body cartridge fuse designed to IEC specification.

Features

- Designed to International IEC Standards for use globally
- Meets the IEC 60127-2, Sheet 3 specification for Time-Lag fuses
- Available in cartridge and axial lead form
- RoHS compliant and lead-free

Applications

Used as supplementary protection in appliance or utilization equipment to provide individual protection for components or internal circuits.

Additional Information



Datasheet



Resources



Samples



Accessories

For recommended fuse accessories for this product series, see '[Recommended Accessories](#)' section.

Electrical Characteristics

% of Ampere Rating	Ampere Rating	Opening Time
150%	0.032A - 0.100A	60 minutes, Minimum
	0.125A - 6.3A	60 minutes, Minimum
	8A - 16A	30 minutes, Minimum
210%	0.032A - 0.100A	120 sec., Maximum
	0.125A - 6.3A	120 sec., Maximum
	8A - 16A	120 sec., Maximum
275%	0.032A - 0.100A	200 ms., Min.; 10 sec. Max.
	0.125A - 6.3A	600 ms., Min.; 10 sec. Max.
	8A - 16A	600 ms., Min.; 10 sec. Max.
400%	0.032A - 0.100A	40 ms., Min.; 3 sec. Max.
	0.125A - 6.3A	150 ms., Min.; 3 sec. Max.
	8A - 16A	150 ms., Min.; 3 sec. Max.
1000%	0.032A - 0.100A	10 ms., Min.; 300 ms. Max.
	0.125A - 6.3A	20 ms., Min.; 300 ms. Max.
	8A - 16A	20 ms., Min.; 300 ms. Max.

Electrical Characteristics

Amp Code	Amp Rating (A)	Voltage Rating (V)	Interrupting Rating	Nominal Cold Resistance (Ohms)	Nominal Melting I ² t (A ² sec)	Maximum Voltage Drop at Rated Current (mV)	Maximum Power Dissipation At 1.5In(W)	Agency Approvals									
								UL	CCC	PS E	RU	SF	CS	CE	D'E		
.032	0.032	250	35 A @ 250 VAC	48.2580	0.01100	5000	1.6		x	x		x	x	x	x	x	
.040	0.04	250		31.8620	0.01100	4000	1.6		x	x		x	x	x	x	x	x
.050	0.05	250		21.2920	0.02700	3500	1.6		x	x		x	x	x	x	x	x
.063	0.063	250		14.2680	0.04600	3000	1.6		x	x		x	x	x	x	x	x
.080	0.08	250		9.0700	0.07500	2500	1.6	x	x	x		x	x	x	x	x	x
.100	0.1	250		6.0180	0.07900	2000	1.6	x	x	x		x	x	x	x	x	x
.125	0.125	250		4.2000	0.1465	1900	1.6	x	x	x		x	x	x	x	x	x
.160	0.16	250		3.7000	0.14400	1500	1.6	x	x	x		x	x	x	x	x	x
.200	0.2	250		1.6000	0.3410	1300	1.6	x	x	x		x	x	x	x	x	x
.250	0.25	250		1.0495	0.5405	1100	1.6	x	x	x		x	x	x	x	x	x
.315	0.315	250		0.8475	1.1100	1000	1.6	x	x	x	1.1100	x	x	x	x	x	x
.400	0.4	250		0.5350	1.3250	900	1.6	x	x	x		x	x	x	x	x	x
.500	0.5	250		0.3700	2.8250	300	1.6	x	x	x		x	x	x	x	x	x
.630	0.63	250		0.2750	4.6750	250	1.6	x	x	x		x	x	x	x	x	x
.800	0.8	250		0.0813	3.370	150	1.6	x	x	x		x	x	x	x	x	x
001.	1	250		0.0613	6.730	150	1.6	x	x	x	x	x	x	x	x	x	x
1.25	1.25	250	0.0446	12.650	150	1.6	x	x	x	x	x	x	x	x	x	x	
01.6	1.6	250	0.0336	23.350	150	1.6	x	x	x	x	x	x	x	x	x	x	
002.	2	250	0.0293	14.450	150	1.6	x	x	x	x	x	x	x	x	x	x	
02.5	2.5	250	0.0219	23.250	120	1.6	x	x	x	x	x	x	x	x	x	x	
3.15	3.15	250	0.0173	38.150	100	1.6	x	x	x	x	x	x	x	x	x	x	
004.	4	250	40 A @ 250 VAC	0.0129	69.10	100	1.6	x	x	x	x	x	x	x	x	x	
005.	5	250	50 A @ 250 VAC	0.0104	111.00	100	1.6	x	x	x	x	x	x	x	x	x	
06.3	6.3	250	63 A @ 250 VAC	0.0076	198.50	100	1.6	x	x	x	x	x	x	x	x	x	
008.	8	250	80 A @ 250 VAC	0.0059	341.50	100	4		x		x	x	x		x	x	
010.	10	250	100 A @ 250 VAC	0.0045	568.00	100	4		x		x	x	x		x	x	
12.5	12.5	250	63 A @ 250 VAC	0.0034	889.00	100	4				x	x			x		
015.	15	250	100 A @ 250 VAC	0.0028	1405.00	100	4				x	x	x		x	x*	
016.	16	250	63 A @ 250 VAC	0.0021	1955.00	100	4				x				x		

* Approval for cartridge versions only

Temperature Re-rating Curve

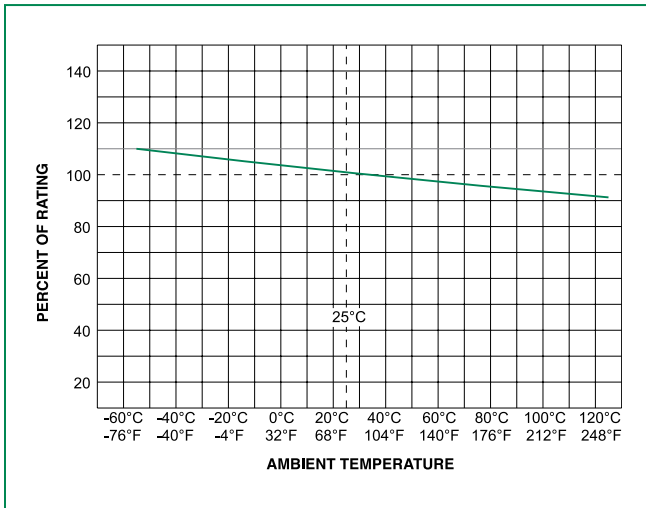

Average Time Current Curves

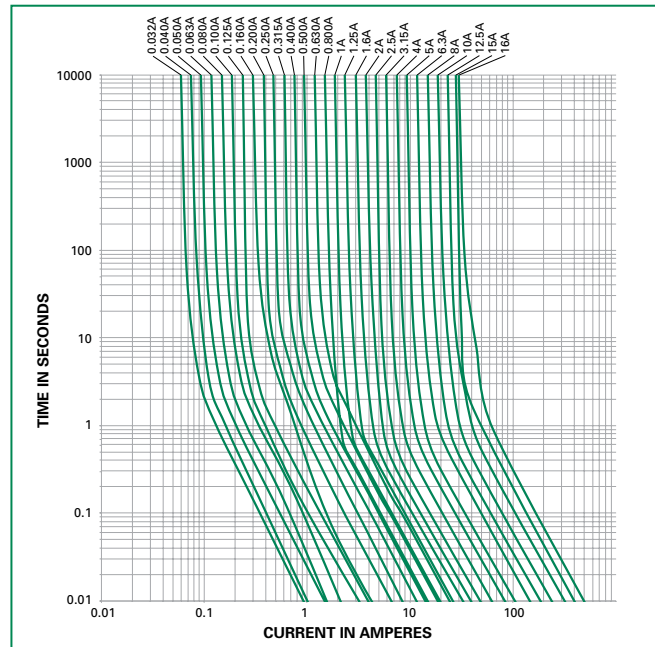

Soldering Parameters - Wave Soldering

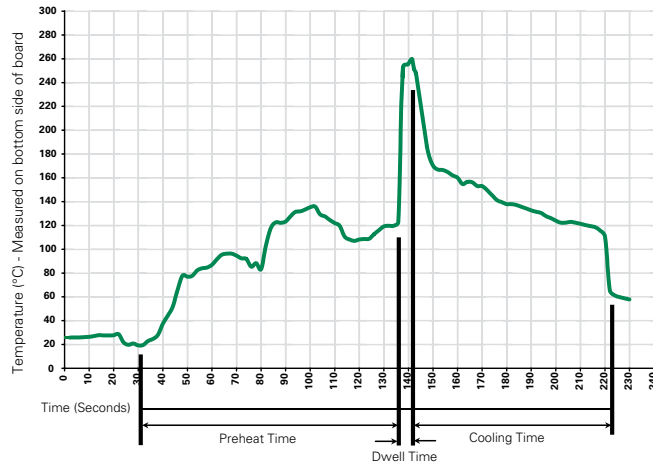

Recommended Process Parameters:

Wave Parameter	Lead-Free Recommendation
Preheat: (Depends on Flux Activation Temperature)	(Typical Industry Recommendation)
Temperature Minimum:	100°C
Temperature Maximum:	150°C
Preheat Time:	60-180 seconds
Solder Pot Temperature:	260°C Maximum
Solder Dwell Time:	2-5 seconds

Recommended Hand-Solder Parameters:

Solder Iron Temperature: 350°C +/- 5°C
 Heating Time: 5 seconds max.

Note: These devices are not recommended for IR or Convection Reflow process.

Product Characteristics

Material	Body: Glass Cap: Nickel-plated Brass Leads: Tin-plated Copper
Terminal Strength	MIL-STD-202, Method 211, Test Condition A
Solderability	MIL-STD-202, Method 208
Product Marking	Cap1: Brand logo, current and voltage ratings Cap2: Agency approval marks
Packaging	Available in Bulk (M=1000 pcs/pkg) or on Tape/Reel (MRET1=1000 pcs/reel)

Operating Temperature	-55°C to +125°C
Thermal Shock	MIL-STD-202, Method 107, Test Condition B (5 cycles, -65°C to +125°C)
Vibration	MIL-STD-202, Method 201
Humidity	MIL-STD-202, Method 103, Test Condition A (High RH (95%) and elevated temperature (40°C) for 240 hours)
Salt Spray	MIL-STD-202, Method 101, Test Condition B

Dimensions

0218 000P

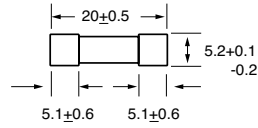

0218.032 XEP
to
0218.100XEP

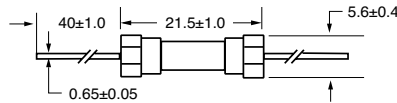

0218.125 XEP
to
0218016. XEP

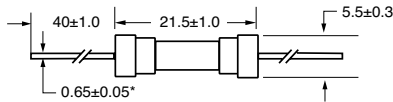

All dimensions in mm

Notes:

* Ratings above 6.3A have 0.8±0.05 diameter lead.

Part Numbering System

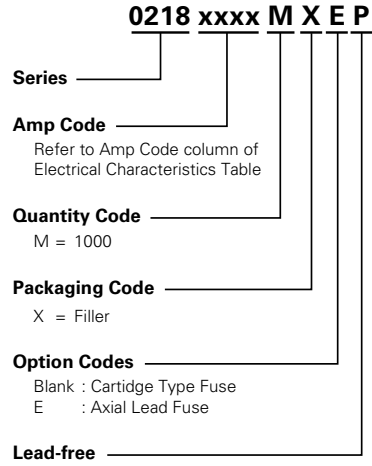

Packaging

Packaging Option	Packaging Specification	Quantity	Quantity & Packaging Code	Taping Width
218 Series				
Bulk	N/A	1000	MX	N/A
Bulk	N/A	1000	MXE	N/A
Reel and Tape	EIA 296-E	1000	MRET1	T1=53mm (2.087")
Bulk	N/A	1000	MXG	N/A
Bulk	N/A	1000	MXB	N/A
Bulk	N/A	100	HX	N/A

Recommended Accessories

Accessory Type	Series	Description	Max Application Voltage	Max Application Amperage
Holder	345_ISF	Panel Mount Shock-Safe Fuseholder	250	10
	345	Shock-Safe Fuseholder with PC Mount, Solder Mount and Panel Mount options		20
	830	PC Mount Shock-Safe Miniature Fuseholder		16
Block	520	Metric OMNI-BLOK® Fuse Block		10
	646	PC Mount Miniature Fuse Block		6.3
	658	Surface Mount Miniature Fuse Block		10
Clip	520_W	PC Mount Miniature Fuse Clip		6.3
	111	PC Board Mount Fuse Clip		10
	445	PC Board Mount Fuse Clip		10

Notes:

- Do not use in applications above rating.
- Please refer to fuseholder data sheet for specific re-rating information.
- Please contact factory for applications greater than the max voltage and amperage shown.

Disclaimer Notice - Information furnished is believed to be accurate and reliable. However, users should independently evaluate the suitability of and test each product selected for their own applications. Littelfuse products are not designed for, and may not be used in, all applications. Read complete Disclaimer Notice at: www.littelfuse.com/disclaimer-electronics.

Looking for pricing, stock, or lifecycle information?

Click below to explore more details on WIN SOURCE:

 [View 0218010.MXP](#) on WIN SOURCE

 [Littelfuse Inc.](#) Information

Optimize Your Supply Chain with WIN SOURCE Solutions

-  Global Sourcing Solution
-  Obsolete Management
-  Cost Control Management
-  Shortage Management
-  Alternative Solution
-  Excess Inventory Management