



# THE DATASHEET OF SN74LVC2G34DBVR





## SN74LVC2G34 Dual Buffer Gate

### 1 Features

- Available in the Texas Instruments NanoFree™ Package
- Supports 5.5-V  $V_{CC}$  Operation
- Inputs Accept Voltages to 5.5 V
- Maximum  $t_{pd}$  of 4.1 ns at 3.3 V
- Low Power Consumption, 10- $\mu$ A Maximum  $I_{CC}$
- $\pm$ 24-mA Output Drive at 3.3 V
- Typical  $V_{OLP}$  (Output Ground Bounce)  $<0.8$  V at  $V_{CC} = 3.3$  V,  $T_A = 25^\circ\text{C}$
- Typical  $V_{OHV}$  (Output  $V_{OH}$  Undershoot)  $>2$  V at  $V_{CC} = 3.3$  V,  $T_A = 25^\circ\text{C}$
- $I_{off}$  Supports Live Insertion, Partial-Power-Down Mode, and Back-Drive Protection
- Can Be Used as a Down Translator to Translate Inputs From a Maximum of 5.5 V Down to the  $V_{CC}$  Level
- Latch-Up Performance Exceeds 100 mA Per JESD 78, Class II
- ESD Protection Exceeds JESD 22
  - 2000-V Human Body Model (A114-A)
  - 200-V Machine Model (A115-A)
  - 1000-V Charged-Device Model (C101)

### 2 Applications

- AV Receivers
- Audio Docks: Portable
- Blu-ray Player and Home Theaters
- DVD Recorders and Players
- Embedded PCs
- MP3 Players and Recorders (Portable Audio)
- Personal Digital Assistant (PDA)
- Power: Telecom/Server AC/DC Supply: Single Controller: Analog and Digital
- Solid-State Drive (SSD): Client and Enterprise
- TV: LCD/Digital and High-Definition (HDTV)
- Tablets: Enterprise
- Video Analytics: Servers
- Wireless Headsets, Keyboards, and Mice

### 3 Description

The SN74LVC2G34 device is a dual buffer gate designed for 1.65-V to 5.5-V  $V_{CC}$  operation. The SN74LVC2G34 device performs the Boolean function  $Y = A$  in positive logic.

NanoFree package technology is a major breakthrough in IC packaging concepts, using the die as the package.

This device is fully specified for partial-power-down applications using  $I_{off}$ . The  $I_{off}$  circuitry disables the outputs, preventing damaging current backflow through the device when it is powered down.

#### Device Information<sup>(1)</sup>

PART NUMBER	PACKAGE	BODY SIZE (NOM)
SN74LVC2G34DBV	SOT-23 (6)	2.90 mm x 1.60 mm
SN74LVC2G34DCK	SC70 (6)	2.00 mm x 1.25 mm
SN74LVC2G34DRL	SOT (6)	1.60 mm x 1.20 mm
SN74LVC2G34YZP	DSBGA (6)	1.41 mm x 0.91 mm

(1) For all available packages, see the orderable addendum at the end of the data sheet.

#### Simplified Schematic

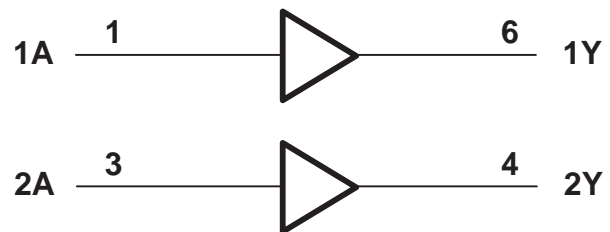

## Table of Contents

<b>1 Features</b> .....	<b>1</b>	8.2 Functional Block Diagram .....	<b>8</b>
<b>2 Applications</b> .....	<b>1</b>	8.3 Feature Description .....	<b>8</b>
<b>3 Description</b> .....	<b>1</b>	8.4 Device Functional Modes .....	<b>8</b>
<b>4 Revision History</b> .....	<b>2</b>	<b>9 Application and Implementation</b> .....	<b>9</b>
<b>5 Pin Configuration and Functions</b> .....	<b>3</b>	9.1 Application Information .....	<b>9</b>
<b>6 Specifications</b> .....	<b>3</b>	9.2 Typical Application .....	<b>9</b>
6.1 Absolute Maximum Ratings .....	<b>3</b>	<b>10 Power Supply Recommendations</b> .....	<b>10</b>
6.2 ESD Ratings .....	<b>4</b>	<b>11 Layout</b> .....	<b>10</b>
6.3 Recommended Operating Conditions .....	<b>4</b>	11.1 Layout Guidelines .....	<b>10</b>
6.4 Thermal Information .....	<b>4</b>	11.2 Layout Example .....	<b>10</b>
6.5 Electrical Characteristics .....	<b>5</b>	<b>12 Device and Documentation Support</b> .....	<b>11</b>
6.6 Switching Characteristics .....	<b>5</b>	12.1 Documentation Support .....	<b>11</b>
6.7 Operating Characteristics .....	<b>5</b>	12.2 Community Resources .....	<b>11</b>
6.8 Typical Characteristics .....	<b>6</b>	12.3 Trademarks .....	<b>11</b>
<b>7 Parameter Measurement Information</b> .....	<b>7</b>	12.4 Electrostatic Discharge Caution .....	<b>11</b>
<b>8 Detailed Description</b> .....	<b>8</b>	12.5 Glossary .....	<b>11</b>
8.1 Overview .....	<b>8</b>	<b>13 Mechanical, Packaging, and Orderable Information</b> .....	<b>11</b>

## 4 Revision History

NOTE: Page numbers for previous revisions may differ from page numbers in the current version.

<b>Changes from Revision I (December 2013) to Revision J</b>	<b>Page</b>
• Added <i>Applications</i> , <i>Device Information</i> table, <i>Pin Configuration and Functions</i> section, <i>ESD Ratings</i> table, <i>Thermal Information</i> table, <i>Typical Characteristics</i> section, <i>Feature Description</i> section, <i>Device Functional Modes</i> , <i>Application and Implementation</i> section, <i>Power Supply Recommendations</i> section, <i>Layout</i> section, <i>Device and Documentation Support</i> section, and <i>Mechanical, Packaging, and Orderable Information</i> section .....	<b>1</b>
• Deleted part number from <i>Switching Characteristics</i> table headers. ....	<b>5</b>

<b>Changes from Revision H (February 2007) to Revision I</b>	<b>Page</b>
• Updated document to new TI data sheet format. ....	<b>1</b>
• Removed <i>Ordering Information</i> table. ....	<b>1</b>
• Updated <i>Features</i> section .....	<b>1</b>
• Updated operating temperature range. ....	<b>4</b>

## 5 Pin Configuration and Functions

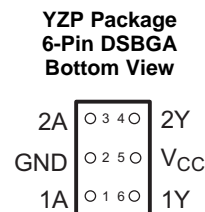
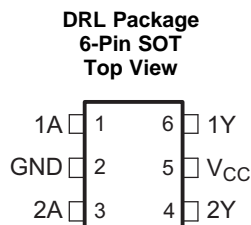
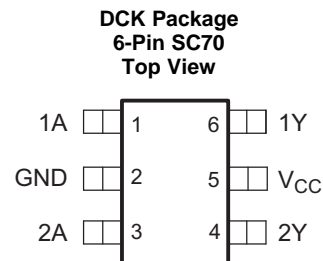
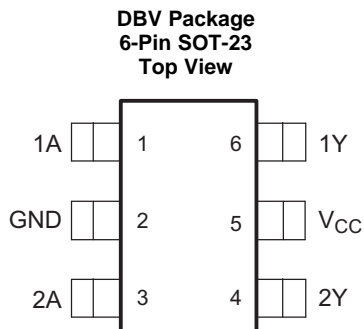

### Pin Functions<sup>(1)</sup>

PIN		I/O	DESCRIPTION
NAME	NO.		
1A	1	I	Buffer Input 1
1Y	6	O	Buffer Output 1
2A	3	I	Buffer Input 2
2Y	4	O	Buffer Output 2
GND	2	—	Ground pin
V <sub>CC</sub>	5	—	Power pin

(1) See mechanical drawings for dimensions.

## 6 Specifications

### 6.1 Absolute Maximum Ratings

over operating free-air temperature range (unless otherwise noted)<sup>(1)</sup>

		MIN	MAX	UNIT	
V <sub>CC</sub>	Supply voltage	-0.5	6.5	V	
V <sub>I</sub>	Input voltage <sup>(2)</sup>	-0.5	6.5	V	
V <sub>O</sub>	Voltage applied to any output in the high-impedance or power-off state <sup>(2)</sup>	-0.5	6.5	V	
V <sub>O</sub>	Voltage applied to any output in the high or low state <sup>(2)(3)</sup>	-0.5	V <sub>CC</sub> + 0.5	V	
I <sub>IK</sub>	Input clamp current	V <sub>I</sub> < 0		-50	mA
I <sub>OK</sub>	Output clamp current	V <sub>O</sub> < 0		-50	mA
I <sub>O</sub>	Continuous output current			±50	mA
	Continuous current through V <sub>CC</sub> or GND			±100	mA
T <sub>J</sub>	Junction temperature			150	°C
T <sub>stg</sub>	Storage temperature	-65	150	°C	

- (1) Stresses beyond those listed under *Absolute Maximum Ratings* may cause permanent damage to the device. These are stress ratings only, and functional operation of the device at these or any other conditions beyond those indicated under *Recommended Operating Conditions* is not implied. Exposure to absolute-maximum-rated conditions for extended periods may affect device reliability.
- (2) The input negative-voltage and output voltage ratings may be exceeded if the input and output current ratings are observed.
- (3) The value of V<sub>CC</sub> is provided in the *Recommended Operating Conditions* table.

## SN74LVC2G34

SCES359J – AUGUST 2001 – REVISED OCTOBER 2015

www.ti.com

### 6.2 ESD Ratings

			VALUE	UNIT
$V_{(ESD)}$	Electrostatic discharge	Human body model (HBM), per ANSI/ESDA/JEDEC JS-001, all pins <sup>(1)</sup>	2500	V
		Charged-device model (CDM), per JEDEC specification JESD22-C101, all pins <sup>(2)</sup>	1500	

(1) JEDEC document JEP155 states that 500-V HBM allows safe manufacturing with a standard ESD control process.

(2) JEDEC document JEP157 states that 250-V CDM allows safe manufacturing with a standard ESD control process.

### 6.3 Recommended Operating Conditions<sup>(1)</sup>

			MIN	MAX	UNIT
$V_{CC}$	Supply voltage	Operating	1.65	5.5	V
		Data retention only	1.5		
$V_{IH}$	High-level input voltage	$V_{CC} = 1.65\text{ V to }1.95\text{ V}$	$0.65 \times V_{CC}$		V
		$V_{CC} = 2.3\text{ V to }2.7\text{ V}$	1.7		
		$V_{CC} = 3\text{ V to }3.6\text{ V}$	2		
		$V_{CC} = 4.5\text{ V to }5.5\text{ V}$	$0.7 \times V_{CC}$		
$V_{IL}$	Low-level input voltage	$V_{CC} = 1.65\text{ V to }1.95\text{ V}$		$0.35 \times V_{CC}$	V
		$V_{CC} = 2.3\text{ V to }2.7\text{ V}$		0.7	
		$V_{CC} = 3\text{ V to }3.6\text{ V}$		0.8	
		$V_{CC} = 4.5\text{ V to }5.5\text{ V}$		$0.3 \times V_{CC}$	
$V_I$	Input voltage		0	5.5	V
$V_O$	Output voltage		0	$V_{CC}$	V
$I_{OH}$	High-level output current	$V_{CC} = 1.65\text{ V}$		-4	mA
		$V_{CC} = 2.3\text{ V}$		-8	
		$V_{CC} = 3\text{ V}$		-16	
		$V_{CC} = 4.5\text{ V}$		-24	
$I_{OL}$	Low-level output current	$V_{CC} = 1.65\text{ V}$		4	mA
		$V_{CC} = 2.3\text{ V}$		8	
		$V_{CC} = 3\text{ V}$		16	
		$V_{CC} = 4.5\text{ V}$		24	
$\Delta t/\Delta v$	Input transition rise or fall rate	$V_{CC} = 1.8\text{ V} \pm 0.15\text{ V}, 2.5\text{ V} \pm 0.2\text{ V}$		20	ns/V
		$V_{CC} = 3.3\text{ V} \pm 0.3\text{ V}$		10	
		$V_{CC} = 5\text{ V} \pm 0.5\text{ V}$		5	
$T_A$	Operating free-air temperature	DBV, DCK, DRL Package	-40	125	°C
		YZP Package	-40	85	

(1) All unused inputs of the device must be held at  $V_{CC}$  or GND to ensure proper device operation. Refer to the TI application report, *Semiconductor and Implications of Slow or Floating CMOS Inputs*, [SCBA004](#).

### 6.4 Thermal Information

THERMAL METRIC <sup>(1)</sup>	SN74LVC2G34				UNIT	
	DBV (SOT-23)	DCK (SC70)	DRL (SOT)	YZP (DSBGA)		
	6 PINS	6 PINS	6 PINS	6 PINS		
$R_{\theta JA}$	Junction-to-ambient thermal resistance	165	259	142	123	°C/W

(1) For more information about traditional and new thermal metrics, see the *IC Package Thermal Metrics* application report, [SPRA953](#).

## 6.5 Electrical Characteristics

over recommended operating free-air temperature range (unless otherwise noted)

PARAMETER		TEST CONDITIONS	V <sub>CC</sub>	MIN	TYP <sup>(1)</sup>	MAX	UNIT
V <sub>OH</sub>		I <sub>OH</sub> = –100 μA	1.65 V to 5.5 V	V <sub>CC</sub> – 0.1			V
		I <sub>OH</sub> = –4 mA	1.65 V	1.2			
		I <sub>OH</sub> = –8 mA	2.3 V	1.9			
		I <sub>OH</sub> = –16 mA	3 V	2.4			
		I <sub>OH</sub> = –24 mA		2.3			
		I <sub>OH</sub> = –32 mA		3.8			
V <sub>OL</sub>		I <sub>OL</sub> = 100 μA	1.65 V to 5.5 V			0.1	V
		I <sub>OL</sub> = 4 mA	1.65 V			0.45	
		I <sub>OL</sub> = 8 mA	2.3 V			0.3	
		I <sub>OL</sub> = 16 mA	3 V			0.4	
		I <sub>OL</sub> = 24 mA				0.55	
		I <sub>OL</sub> = 32 mA				0.55	
I <sub>I</sub>	A inputs	V <sub>I</sub> = 5.5 V or GND	0 to 5.5 V			±5	μA
I <sub>off</sub>		V <sub>I</sub> or V <sub>O</sub> = 5.5 V	0			±10	μA
I <sub>CC</sub>		V <sub>I</sub> = 5.5 V or GND, I <sub>O</sub> = 0	1.65 V to 5.5 V			10	μA
ΔI <sub>CC</sub>		One input at V <sub>CC</sub> – 0.6 V, Other inputs at V <sub>CC</sub> or GND	3 V to 5.5 V			500	μA
C <sub>i</sub>		V <sub>I</sub> = V <sub>CC</sub> or GND	3.3 V	3.5			pF

(1) All typical values are at V<sub>CC</sub> = 3.3 V, T<sub>A</sub> = 25°C.

## 6.6 Switching Characteristics

over recommended operating free-air temperature range (unless otherwise noted) (see Figure 2)

PARAMETER	FROM (INPUT)	TO (OUTPUT)	OPERATING FREE-AIR TEMPERATURE (T <sub>A</sub> )	V <sub>CC</sub>	MIN	MAX	UNIT
t <sub>pd</sub>	A	Y	–40°C to 85°C	V <sub>CC</sub> = 1.8 V ± 0.15 V	3.2	8.6	ns
				V <sub>CC</sub> = 2.5 V ± 0.2 V	1.5	4.4	
				V <sub>CC</sub> = 3.3 V ± 0.3 V	1.4	4.1	
				V <sub>CC</sub> = 5 V ± 0.5 V	1	3.2	
t <sub>pd</sub>	A	Y	–40°C to 125°C	V <sub>CC</sub> = 1.8 V ± 0.15 V	3.2	9.6	ns
				V <sub>CC</sub> = 2.5 V ± 0.2 V	1.5	4.9	
				V <sub>CC</sub> = 3.3 V ± 0.3 V	1.2	4.6	
				V <sub>CC</sub> = 5 V ± 0.5 V	1	3.7	

## 6.7 Operating Characteristics

T<sub>A</sub> = 25°C

PARAMETER		TEST CONDITIONS	V <sub>CC</sub>	TYP	UNIT
C <sub>pd</sub>	Power dissipation capacitance	f = 10 MHz	V <sub>CC</sub> = 1.8 V	14	pF
			V <sub>CC</sub> = 2.5 V	14	
			V <sub>CC</sub> = 3.3 V	15	
			V <sub>CC</sub> = 5 V	17	

## 6.8 Typical Characteristics

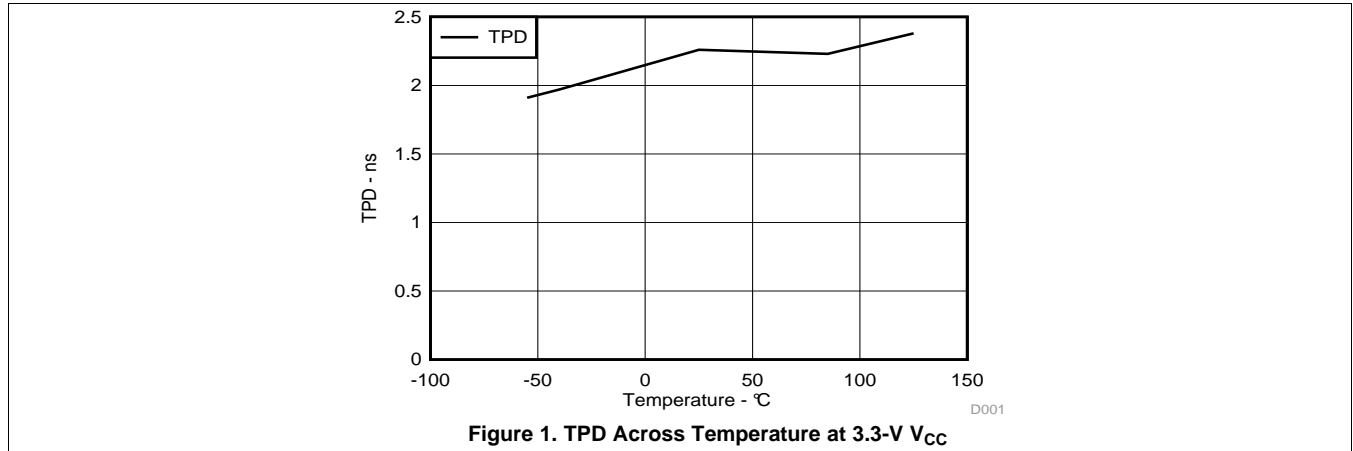

## 7 Parameter Measurement Information

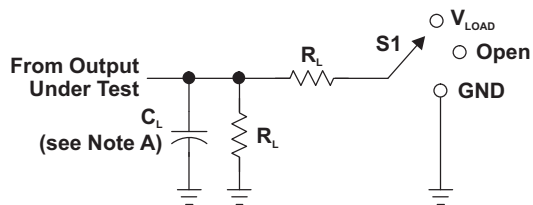

LOAD CIRCUIT

TEST	S1
$t_{PLH}/t_{PHL}$	Open
$t_{PLZ}/t_{PZL}$	$V_{LOAD}$
$t_{PHZ}/t_{PZH}$	GND

$V_{CC}$	INPUTS		$V_M$	$V_{LOAD}$	$C_L$	$R_L$	$V_{\Delta}$
	$V_i$	$t_i/t_r$					
$1.8\text{ V} \pm 0.15\text{ V}$	$V_{CC}$	$\leq 2\text{ ns}$	$V_{CC}/2$	$2 \times V_{CC}$	30 pF	1 k $\Omega$	0.15 V
$2.5\text{ V} \pm 0.2\text{ V}$	$V_{CC}$	$\leq 2\text{ ns}$	$V_{CC}/2$	$2 \times V_{CC}$	30 pF	500 $\Omega$	0.15 V
$3.3\text{ V} \pm 0.3\text{ V}$	3 V	$\leq 2.5\text{ ns}$	1.5 V	6 V	50 pF	500 $\Omega$	0.3 V
$5\text{ V} \pm 0.5\text{ V}$	$V_{CC}$	$\leq 2.5\text{ ns}$	$V_{CC}/2$	$2 \times V_{CC}$	50 pF	500 $\Omega$	0.3 V



VOLTAGE WAVEFORMS PULSE DURATION

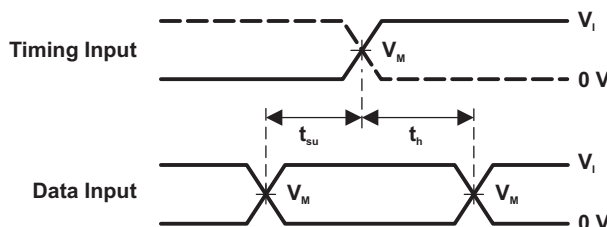

VOLTAGE WAVEFORMS SETUP AND HOLD TIMES



VOLTAGE WAVEFORMS PROPAGATION DELAY TIMES INVERTING AND NONINVERTING OUTPUTS



VOLTAGE WAVEFORMS ENABLE AND DISABLE TIMES LOW- AND HIGH-LEVEL ENABLING

- NOTES:
- A.  $C_L$  includes probe and jig capacitance.
  - B. Waveform 1 is for an output with internal conditions such that the output is low, except when disabled by the output control. Waveform 2 is for an output with internal conditions such that the output is high, except when disabled by the output control.
  - C. All input pulses are supplied by generators having the following characteristics: PRR  $\leq$  10 MHz,  $Z_o = 50\ \Omega$ .
  - D. The outputs are measured one at a time, with one transition per measurement.
  - E.  $t_{PLZ}$  and  $t_{PHZ}$  are the same as  $t_{dis}$ .
  - F.  $t_{PZL}$  and  $t_{PZH}$  are the same as  $t_{en}$ .
  - G.  $t_{PLH}$  and  $t_{PHL}$  are the same as  $t_{pd}$ .
  - H. All parameters and waveforms are not applicable to all devices.

Figure 2. Load Circuit and Voltage Waveforms

## 8 Detailed Description

### 8.1 Overview

The SN74LVC2G34 device contains two buffer gates that each perform the Boolean function  $Y = A$ . This device is fully specified for partial-power-down applications using  $I_{off}$ . The  $I_{off}$  circuitry disables the outputs, preventing damaging current backflow through the device when it is powered down.

### 8.2 Functional Block Diagram

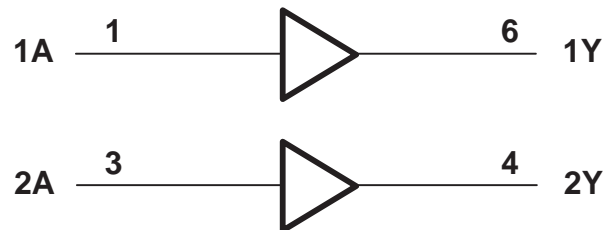

### 8.3 Feature Description

The SN74LVC2G34 device has a wider operating voltage range, operating from 1.65 V to 5.5 V, and allows down voltage translation. The SN74LVC2G34  $I_{off}$  feature allows voltages on the inputs and outputs when  $V_{CC}$  is 0 V.

### 8.4 Device Functional Modes

[Table 1](#) lists the functional modes of the SN74LVC2G34.

**Table 1. Function Table**

INPUT A	OUTPUT Y
H	H
L	L

## 9 Application and Implementation

### 9.1 Application Information

The SN74LVC2G34 is a high-drive CMOS device that can be used as a buffer with a high output drive, such as an LED application. It can produce 24 mA of drive current at 3.3 V, making it ideal for driving multiple outputs and good for high-speed applications up to 100 MHz. The inputs are 5.5-V tolerant allowing it to translate down to  $V_{CC}$ .

### 9.2 Typical Application

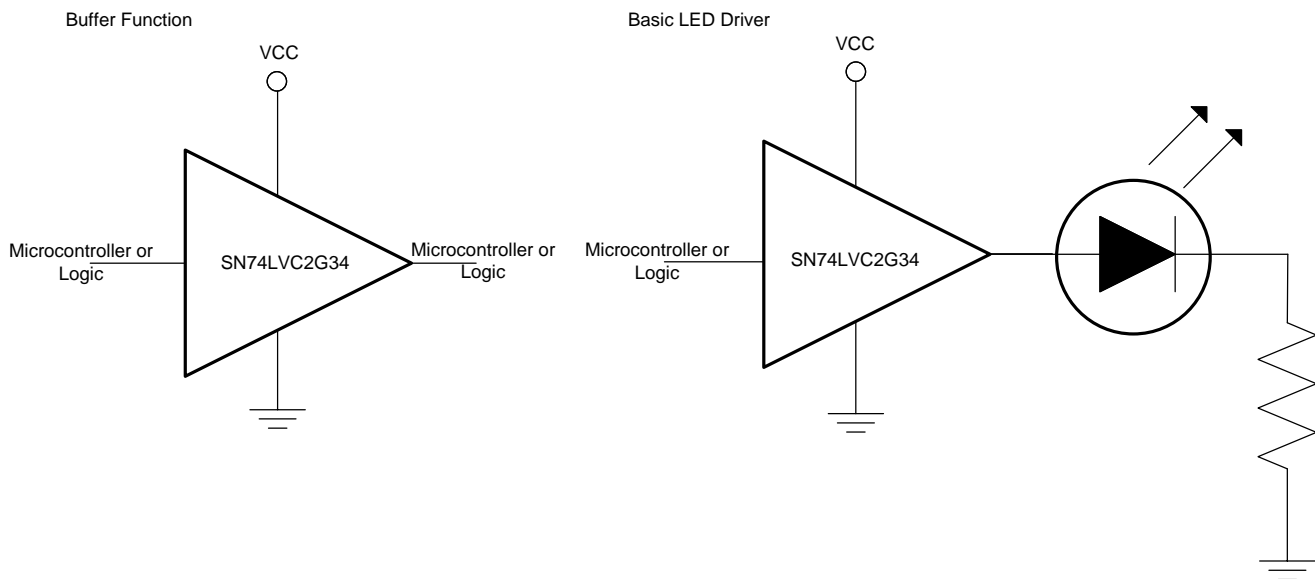

**Figure 3. Typical Application**

#### 9.2.1 Design Requirements

This device uses CMOS technology and has balanced output drive. Take care to avoid bus contention because it can drive currents that would exceed maximum limits. The high drive will also create fast edges into light loads so routing and load conditions must be considered to prevent ringing.

#### 9.2.2 Detailed Design Procedure

1. Recommended Input Conditions
  - Rise time and fall time specs. See  $(\Delta t/\Delta V)$  in the [Recommended Operating Conditions](#) table.
  - Specified high and low levels. See  $(V_{IH}$  and  $V_{IL})$  in the [Recommended Operating Conditions](#) table.
  - Inputs are overvoltage tolerant allowing them to go as high as  $(VI \text{ max})$  in the [Recommended Operating Conditions](#) table at any valid  $V_{CC}$ .
2. Recommended Output Conditions
  - Load currents must not exceed  $(I_O \text{ max})$  per output and must not exceed (Continuous current through  $V_{CC}$  or GND) total current for the part. These limits are located in the [Recommended Operating Conditions](#) table.
  - Outputs must not be pulled above  $V_{CC}$  under normal operating conditions.

## Typical Application (continued)

### 9.2.3 Application Curve

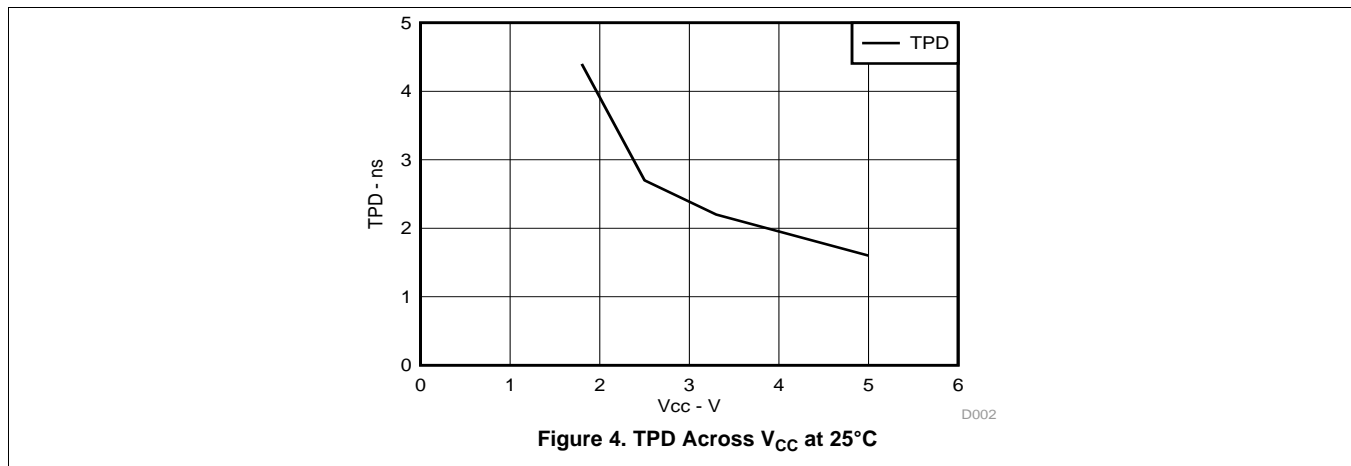

## 10 Power Supply Recommendations

The power supply can be any voltage between the minimum and maximum supply voltage rating located in the [Recommended Operating Conditions](#) table.

Each V<sub>CC</sub> pin must have a good bypass capacitor to prevent power disturbance. For devices with a single supply, a 0.1-μF capacitor is recommended and if there are multiple V<sub>CC</sub> pins then a 0.01-μF or 0.022-μF capacitor is recommended for each power pin. It is ok to parallel multiple bypass caps to reject different frequencies of noise. 0.1-μF and 1-μF capacitors are commonly used in parallel. The bypass capacitor must be installed as close to the power pin as possible for best results.

## 11 Layout

### 11.1 Layout Guidelines

When using multiple bit logic devices inputs must not ever float. In many cases, functions or parts of functions of digital logic devices are unused; for example, when only two inputs of a triple-input AND gate are used or only 3 of the 4 buffer gates are used. Such input pins must not be left unconnected because the undefined voltages at the outside connections result in undefined operational states. Specified below are the rules that must be observed under all circumstances. All unused inputs of digital logic devices must be connected to a high or low bias to prevent them from floating. The logic level that must be applied to any particular unused input depends on the function of the device. Generally they will be tied to GND or V<sub>CC</sub> whichever make more sense or is more convenient.

### 11.2 Layout Example



## 12 Device and Documentation Support

### 12.1 Documentation Support

#### 12.1.1 Documentation Support

For related documentation, see the following:

*Implications of Slow or Floating CMOS Inputs*, [SCBA004](#)

### 12.2 Community Resources

The following links connect to TI community resources. Linked contents are provided "AS IS" by the respective contributors. They do not constitute TI specifications and do not necessarily reflect TI's views; see TI's [Terms of Use](#).

**TI E2E™ Online Community** *TI's Engineer-to-Engineer (E2E) Community*. Created to foster collaboration among engineers. At [e2e.ti.com](#), you can ask questions, share knowledge, explore ideas and help solve problems with fellow engineers.

**Design Support** *TI's Design Support* Quickly find helpful E2E forums along with design support tools and contact information for technical support.

### 12.3 Trademarks

NanoFree, E2E are trademarks of Texas Instruments.  
All other trademarks are the property of their respective owners.

### 12.4 Electrostatic Discharge Caution



These devices have limited built-in ESD protection. The leads should be shorted together or the device placed in conductive foam during storage or handling to prevent electrostatic damage to the MOS gates.

### 12.5 Glossary

[SLYZ022](#) — *TI Glossary*.

This glossary lists and explains terms, acronyms, and definitions.

## 13 Mechanical, Packaging, and Orderable Information

The following pages include mechanical packaging and orderable information. This information is the most current data available for the designated devices. This data is subject to change without notice and revision of this document. For browser based versions of this data sheet, refer to the left hand navigation.

**PACKAGING INFORMATION**

Orderable Device	Status (1)	Package Type	Package Drawing	Pins	Package Qty	Eco Plan (2)	Lead finish/ Ball material (6)	MSL Peak Temp (3)	Op Temp (°C)	Device Marking (4/5)	Samples
SN74LVC2G34DBVR	ACTIVE	SOT-23	DBV	6	3000	RoHS & Green	NIPDAU   SN	Level-1-260C-UNLIM	-40 to 125	(C345, C34F, C34K, C34O, C34R)	<a href="#">Samples</a>
SN74LVC2G34DBVRE4	ACTIVE	SOT-23	DBV	6	3000	RoHS & Green	NIPDAU	Level-1-260C-UNLIM	-40 to 125	(C34F, C34R)	<a href="#">Samples</a>
SN74LVC2G34DBVRG4	ACTIVE	SOT-23	DBV	6	3000	RoHS & Green	NIPDAU	Level-1-260C-UNLIM	-40 to 125	(C34F, C34R)	<a href="#">Samples</a>
SN74LVC2G34DBVT	ACTIVE	SOT-23	DBV	6	250	RoHS & Green	NIPDAU   SN	Level-1-260C-UNLIM	-40 to 125	(C345, C34F, C34K, C34R)	<a href="#">Samples</a>
SN74LVC2G34DBVTG4	ACTIVE	SOT-23	DBV	6	250	RoHS & Green	NIPDAU	Level-1-260C-UNLIM	-40 to 125	(C34F, C34R)	<a href="#">Samples</a>
SN74LVC2G34DCK3	ACTIVE	SC70	DCK	6	3000	RoHS & Non-Green	SNBI	Level-1-260C-UNLIM	-40 to 85	C9Z	<a href="#">Samples</a>
SN74LVC2G34DCKR	ACTIVE	SC70	DCK	6	3000	RoHS & Green	NIPDAU   SN	Level-1-260C-UNLIM	-40 to 125	(C95, C9F, C9K, C9R)	<a href="#">Samples</a>
SN74LVC2G34DCKRE4	ACTIVE	SC70	DCK	6	3000	RoHS & Green	NIPDAU	Level-1-260C-UNLIM	-40 to 125	C95	<a href="#">Samples</a>
SN74LVC2G34DCKRG4	ACTIVE	SC70	DCK	6	3000	RoHS & Green	NIPDAU	Level-1-260C-UNLIM	-40 to 125	C95	<a href="#">Samples</a>
SN74LVC2G34DRLR	ACTIVE	SOT-5X3	DRL	6	4000	RoHS & Green	NIPDAU   NIPDAUAG	Level-1-260C-UNLIM	-40 to 125	(1K8, C97, C9R)	<a href="#">Samples</a>
SN74LVC2G34YZPR	ACTIVE	DSBGA	YZP	6	3000	RoHS & Green	SNAGCU	Level-1-260C-UNLIM	-40 to 85	C9N	<a href="#">Samples</a>

(1) The marketing status values are defined as follows:

**ACTIVE:** Product device recommended for new designs.

**LIFEBUY:** TI has announced that the device will be discontinued, and a lifetime-buy period is in effect.

**NRND:** Not recommended for new designs. Device is in production to support existing customers, but TI does not recommend using this part in a new design.

**PREVIEW:** Device has been announced but is not in production. Samples may or may not be available.

**OBsolete:** TI has discontinued the production of the device.

(2) **RoHS:** TI defines "RoHS" to mean semiconductor products that are compliant with the current EU RoHS requirements for all 10 RoHS substances, including the requirement that RoHS substance do not exceed 0.1% by weight in homogeneous materials. Where designed to be soldered at high temperatures, "RoHS" products are suitable for use in specified lead-free processes. TI may reference these types of products as "Pb-Free".

**RoHS Exempt:** TI defines "RoHS Exempt" to mean products that contain lead but are compliant with EU RoHS pursuant to a specific EU RoHS exemption.

**Green:** TI defines "Green" to mean the content of Chlorine (Cl) and Bromine (Br) based flame retardants meet JS709B low halogen requirements of <=1000ppm threshold. Antimony trioxide based flame retardants must also meet the <=1000ppm threshold requirement.

- (3) MSL, Peak Temp. - The Moisture Sensitivity Level rating according to the JEDEC industry standard classifications, and peak solder temperature.
- (4) There may be additional marking, which relates to the logo, the lot trace code information, or the environmental category on the device.
- (5) Multiple Device Markings will be inside parentheses. Only one Device Marking contained in parentheses and separated by a "~" will appear on a device. If a line is indented then it is a continuation of the previous line and the two combined represent the entire Device Marking for that device.
- (6) Lead finish/Ball material - Orderable Devices may have multiple material finish options. Finish options are separated by a vertical ruled line. Lead finish/Ball material values may wrap to two lines if the finish value exceeds the maximum column width.

**Important Information and Disclaimer:**The information provided on this page represents TI's knowledge and belief as of the date that it is provided. TI bases its knowledge and belief on information provided by third parties, and makes no representation or warranty as to the accuracy of such information. Efforts are underway to better integrate information from third parties. TI has taken and continues to take reasonable steps to provide representative and accurate information but may not have conducted destructive testing or chemical analysis on incoming materials and chemicals. TI and TI suppliers consider certain information to be proprietary, and thus CAS numbers and other limited information may not be available for release.

In no event shall TI's liability arising out of such information exceed the total purchase price of the TI part(s) at issue in this document sold by TI to Customer on an annual basis.

**OTHER QUALIFIED VERSIONS OF SN74LVC2G34 :**

- Enhanced Product : [SN74LVC2G34-EP](#)

NOTE: Qualified Version Definitions:

- Enhanced Product - Supports Defense, Aerospace and Medical Applications

**TAPE AND REEL INFORMATION**

**QUADRANT ASSIGNMENTS FOR PIN 1 ORIENTATION IN TAPE**

\*All dimensions are nominal

Device	Package Type	Package Drawing	Pins	SPQ	Reel Diameter (mm)	Reel Width W1 (mm)	A0 (mm)	B0 (mm)	K0 (mm)	P1 (mm)	W (mm)	Pin1 Quadrant
SN74LVC2G34DBVR	SOT-23	DBV	6	3000	180.0	8.4	3.2	3.2	1.4	4.0	8.0	Q3
SN74LVC2G34DBVRG4	SOT-23	DBV	6	3000	178.0	9.0	3.23	3.17	1.37	4.0	8.0	Q3
SN74LVC2G34DBVT	SOT-23	DBV	6	250	178.0	9.0	3.23	3.17	1.37	4.0	8.0	Q3
SN74LVC2G34DBVT	SOT-23	DBV	6	250	180.0	8.4	3.23	3.17	1.37	4.0	8.0	Q3
SN74LVC2G34DBVTG4	SOT-23	DBV	6	250	178.0	9.0	3.23	3.17	1.37	4.0	8.0	Q3
SN74LVC2G34DCKR	SC70	DCK	6	3000	180.0	8.4	2.3	2.5	1.2	4.0	8.0	Q3
SN74LVC2G34DCKRG4	SC70	DCK	6	3000	178.0	9.2	2.4	2.4	1.22	4.0	8.0	Q3
SN74LVC2G34DRLR	SOT-5X3	DRL	6	4000	180.0	8.4	2.0	1.8	0.75	4.0	8.0	Q3
SN74LVC2G34YZPR	DSBGA	YZP	6	3000	178.0	9.2	1.02	1.52	0.63	4.0	8.0	Q1

**TAPE AND REEL BOX DIMENSIONS**

\*All dimensions are nominal

Device	Package Type	Package Drawing	Pins	SPQ	Length (mm)	Width (mm)	Height (mm)
SN74LVC2G34DBVR	SOT-23	DBV	6	3000	210.0	185.0	35.0
SN74LVC2G34DBVRG4	SOT-23	DBV	6	3000	180.0	180.0	18.0
SN74LVC2G34DBVT	SOT-23	DBV	6	250	180.0	180.0	18.0
SN74LVC2G34DBVT	SOT-23	DBV	6	250	202.0	201.0	28.0
SN74LVC2G34DBVTG4	SOT-23	DBV	6	250	180.0	180.0	18.0
SN74LVC2G34DCKR	SC70	DCK	6	3000	210.0	185.0	35.0
SN74LVC2G34DCKRG4	SC70	DCK	6	3000	180.0	180.0	18.0
SN74LVC2G34DRLR	SOT-5X3	DRL	6	4000	210.0	185.0	35.0
SN74LVC2G34YZPR	DSBGA	YZP	6	3000	220.0	220.0	35.0



# DBV0006A

# PACKAGE OUTLINE

## SOT-23 - 1.45 mm max height

SMALL OUTLINE TRANSISTOR

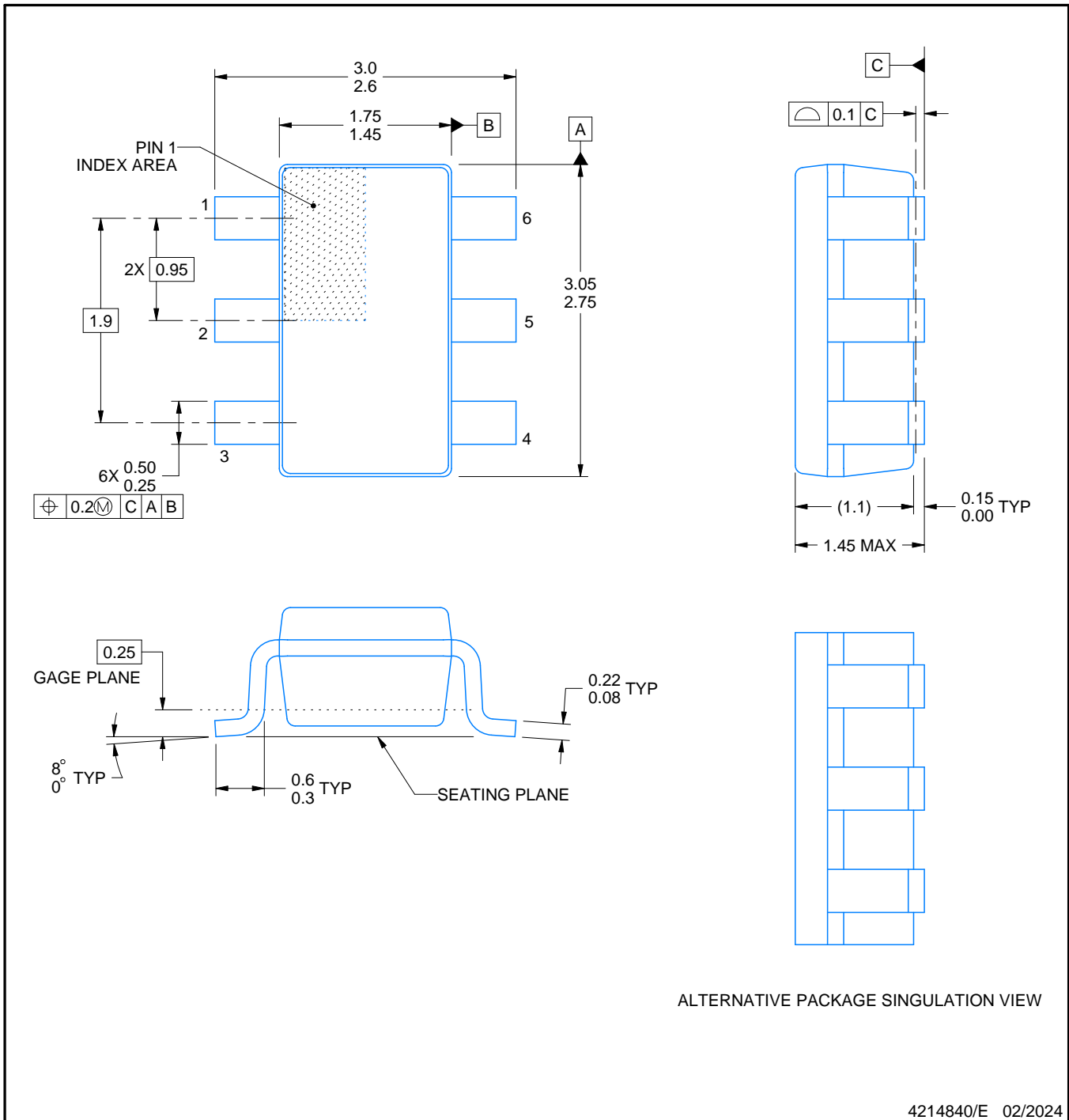

### NOTES:

1. All linear dimensions are in millimeters. Any dimensions in parenthesis are for reference only. Dimensioning and tolerancing per ASME Y14.5M.
2. This drawing is subject to change without notice.
3. Body dimensions do not include mold flash or protrusion. Mold flash and protrusion shall not exceed 0.25 per side.
4. Leads 1,2,3 may be wider than leads 4,5,6 for package orientation.
5. Reference JEDEC MO-178.

# EXAMPLE BOARD LAYOUT

DBV0006A

SOT-23 - 1.45 mm max height

SMALL OUTLINE TRANSISTOR

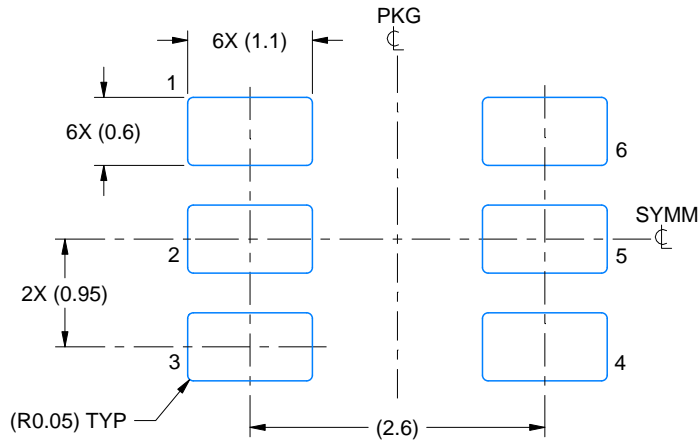

LAND PATTERN EXAMPLE  
EXPOSED METAL SHOWN  
SCALE:15X

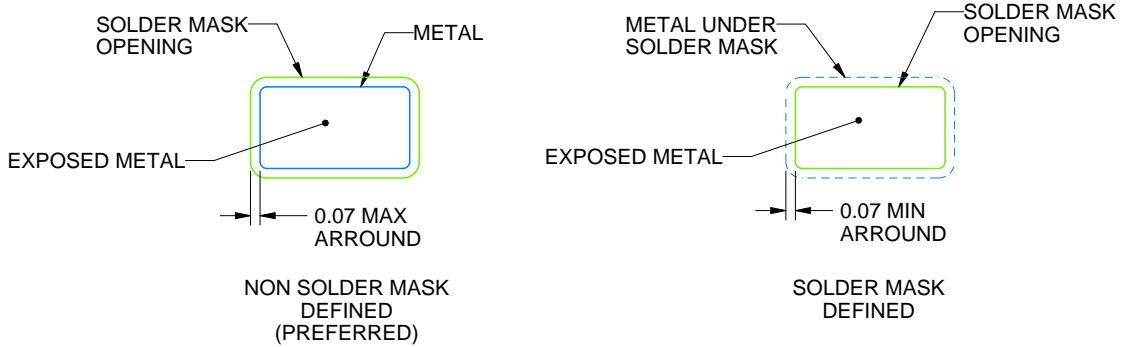

SOLDER MASK DETAILS

4214840/E 02/2024

NOTES: (continued)

- 6. Publication IPC-7351 may have alternate designs.
- 7. Solder mask tolerances between and around signal pads can vary based on board fabrication site.

# EXAMPLE STENCIL DESIGN

DBV0006A

SOT-23 - 1.45 mm max height

SMALL OUTLINE TRANSISTOR

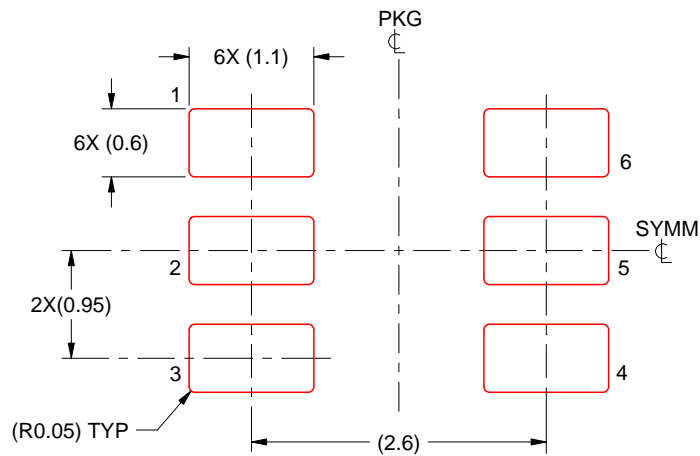

SOLDER PASTE EXAMPLE  
BASED ON 0.125 mm THICK STENCIL  
SCALE:15X

4214840/E 02/2024

NOTES: (continued)

8. Laser cutting apertures with trapezoidal walls and rounded corners may offer better paste release. IPC-7525 may have alternate design recommendations.
9. Board assembly site may have different recommendations for stencil design.

YZP0006

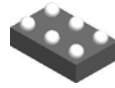

PACKAGE OUTLINE

DSBGA - 0.5 mm max height

DIE SIZE BALL GRID ARRAY

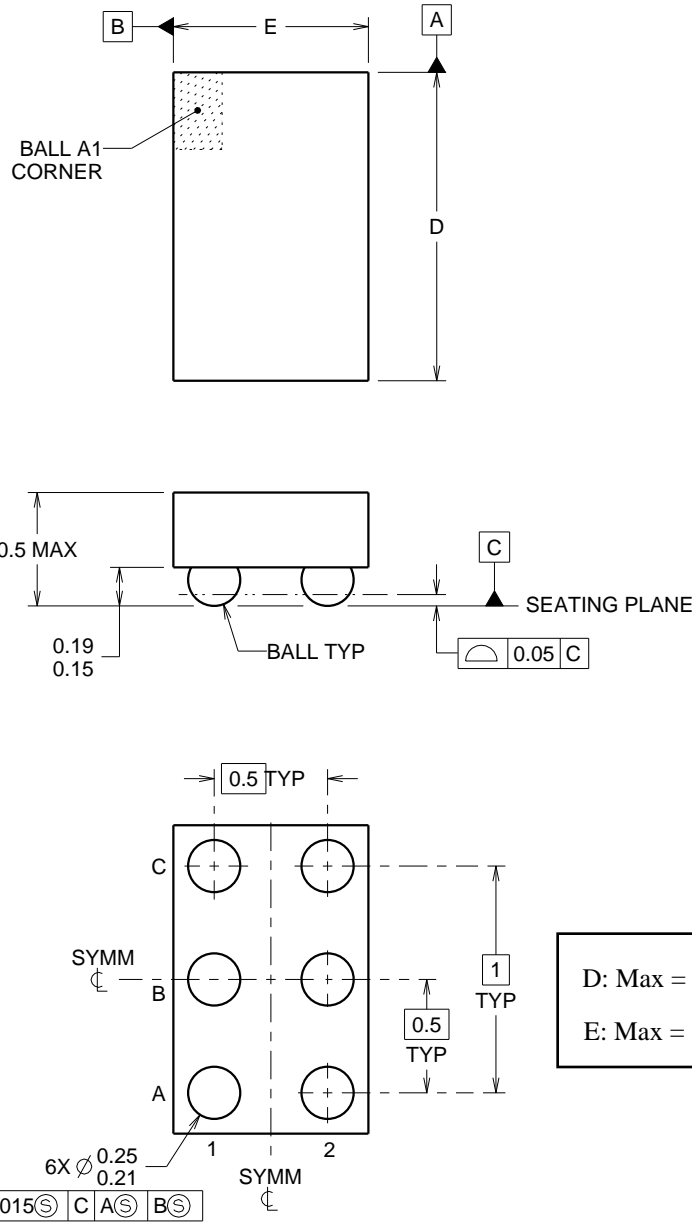

D: Max = 1.418 mm, Min = 1.358 mm  
 E: Max = 0.918 mm, Min = 0.858 mm

4219524/A 06/2014

NOTES:

NanoFree Is a trademark of Texas Instruments.

1. All linear dimensions are in millimeters. Any dimensions in parenthesis are for reference only. Dimensioning and tolerancing per ASME Y14.5M.
2. This drawing is subject to change without notice.
3. NanoFree™ package configuration.

# EXAMPLE BOARD LAYOUT

YZP0006

DSBGA - 0.5 mm max height

DIE SIZE BALL GRID ARRAY

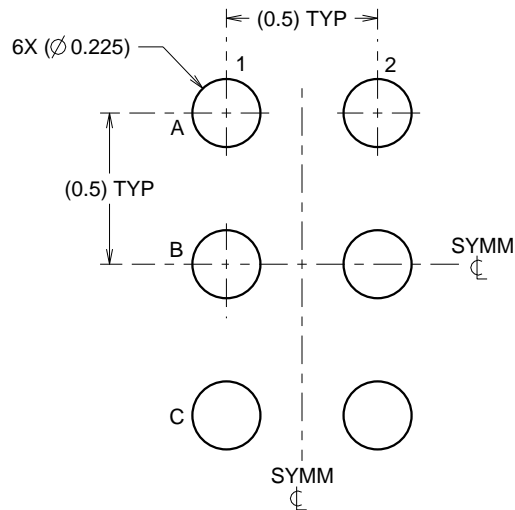

LAND PATTERN EXAMPLE  
SCALE:40X

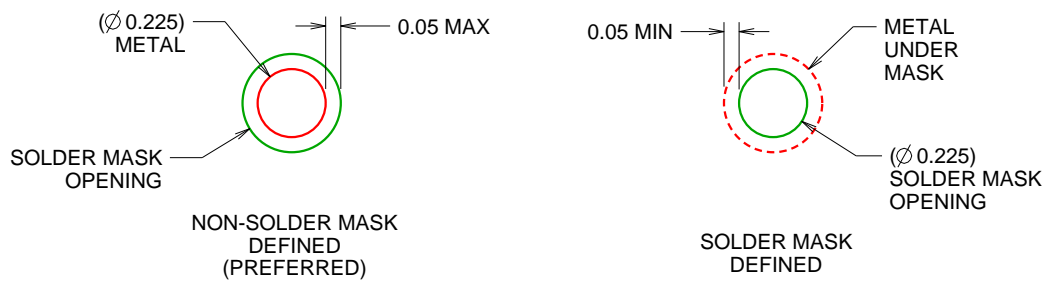

SOLDER MASK DETAILS  
NOT TO SCALE

4219524/A 06/2014

NOTES: (continued)

- 4. Final dimensions may vary due to manufacturing tolerance considerations and also routing constraints. For more information, see Texas Instruments literature number SBVA017 ([www.ti.com/lit/sbva017](http://www.ti.com/lit/sbva017)).

# EXAMPLE STENCIL DESIGN

YZP0006

DSBGA - 0.5 mm max height

DIE SIZE BALL GRID ARRAY

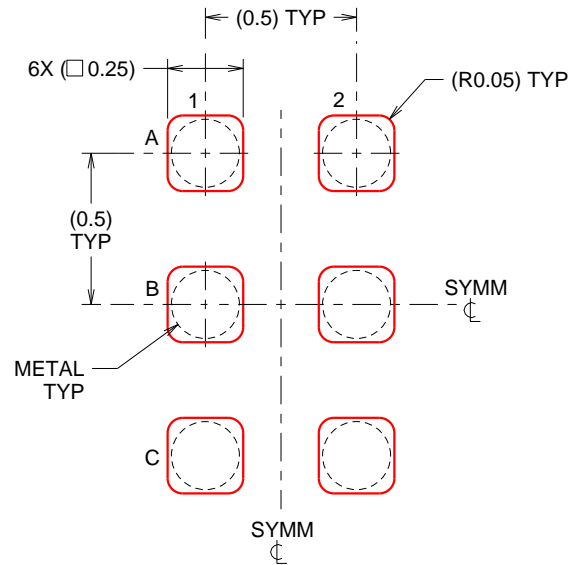

SOLDER PASTE EXAMPLE  
BASED ON 0.1 mm THICK STENCIL  
SCALE:40X

4219524/A 06/2014

NOTES: (continued)

5. Laser cutting apertures with trapezoidal walls and rounded corners may offer better paste release.

# DCK0006A



# PACKAGE OUTLINE

SOT - 1.1 max height

SMALL OUTLINE TRANSISTOR

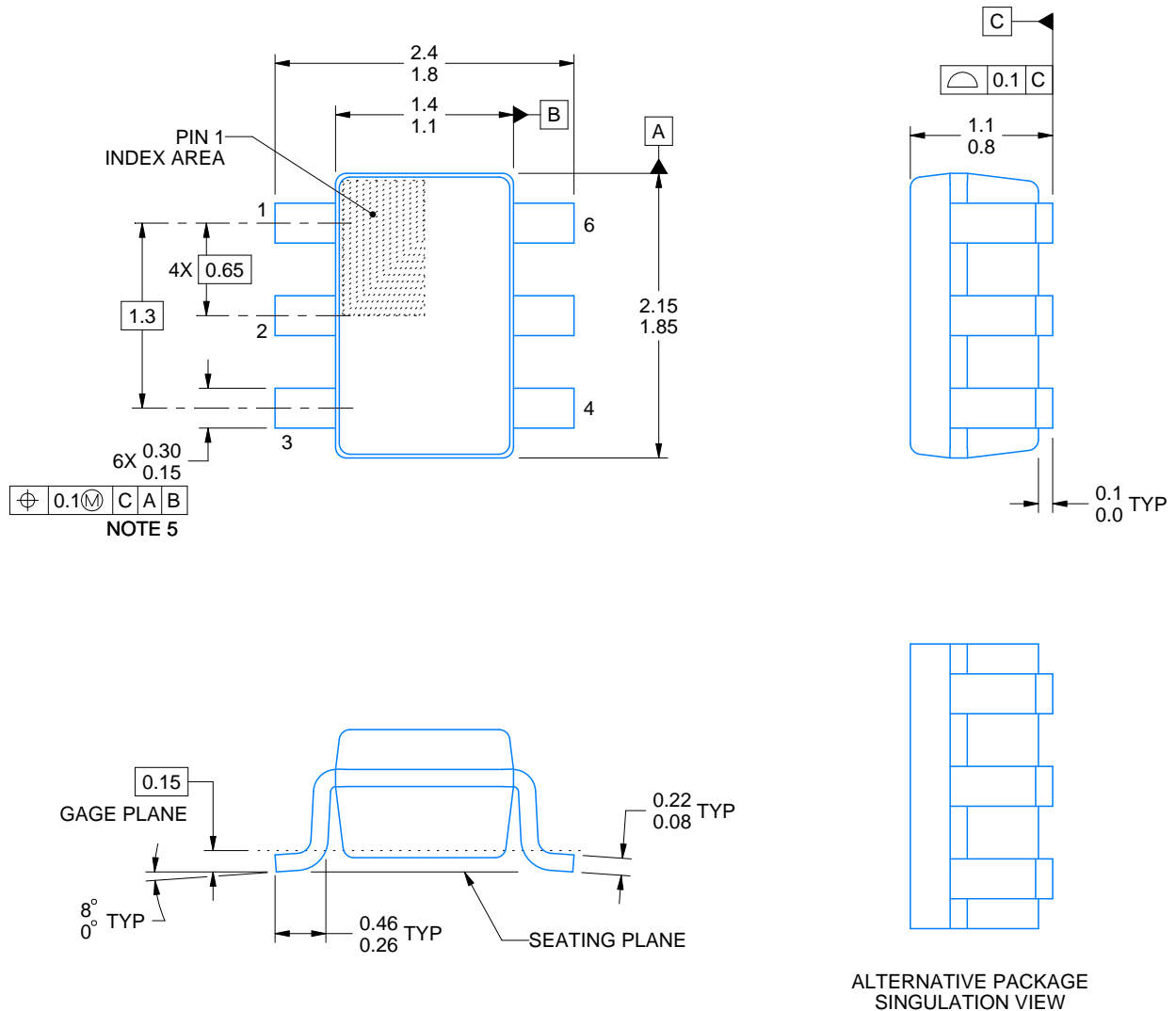

4214835/B 04/2024

**NOTES:**

1. All linear dimensions are in millimeters. Any dimensions in parenthesis are for reference only. Dimensioning and tolerancing per ASME Y14.5M.
2. This drawing is subject to change without notice.
3. Body dimensions do not include mold flash or protrusion. Mold flash and protrusion shall not exceed 0.15 per side.
4. Falls within JEDEC MO-203 variation AB.

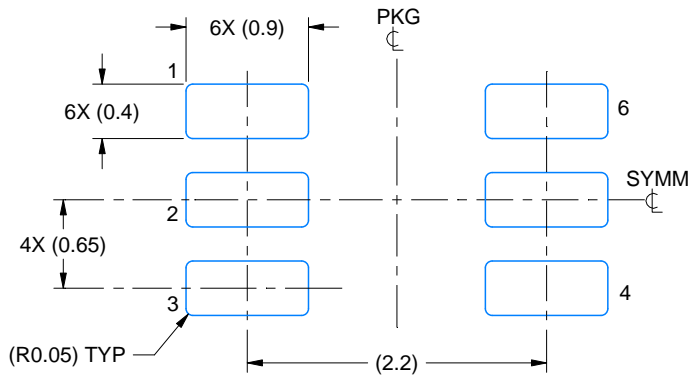

LAND PATTERN EXAMPLE  
EXPOSED METAL SHOWN  
SCALE:18X

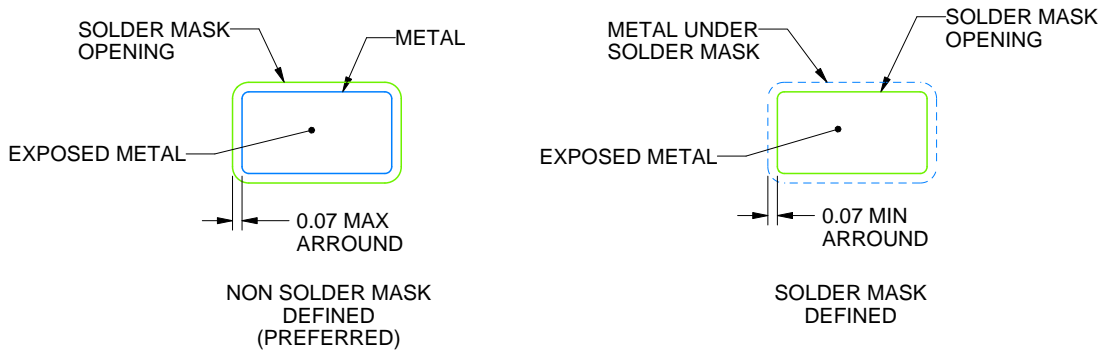

SOLDER MASK DETAILS

4214835/B 04/2024

NOTES: (continued)

5. Publication IPC-7351 may have alternate designs.
6. Solder mask tolerances between and around signal pads can vary based on board fabrication site.

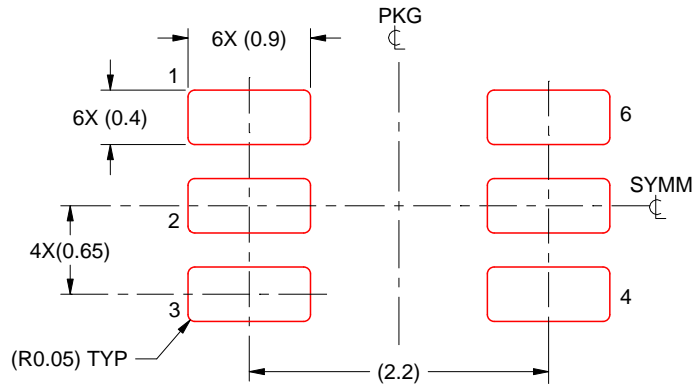

SOLDER PASTE EXAMPLE  
BASED ON 0.125 THICK STENCIL  
SCALE:18X

4214835/B 04/2024

NOTES: (continued)

7. Laser cutting apertures with trapezoidal walls and rounded corners may offer better paste release. IPC-7525 may have alternate design recommendations.
8. Board assembly site may have different recommendations for stencil design.

# DRL0006A

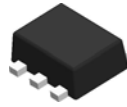

# PACKAGE OUTLINE

## SOT - 0.6 mm max height

PLASTIC SMALL OUTLINE

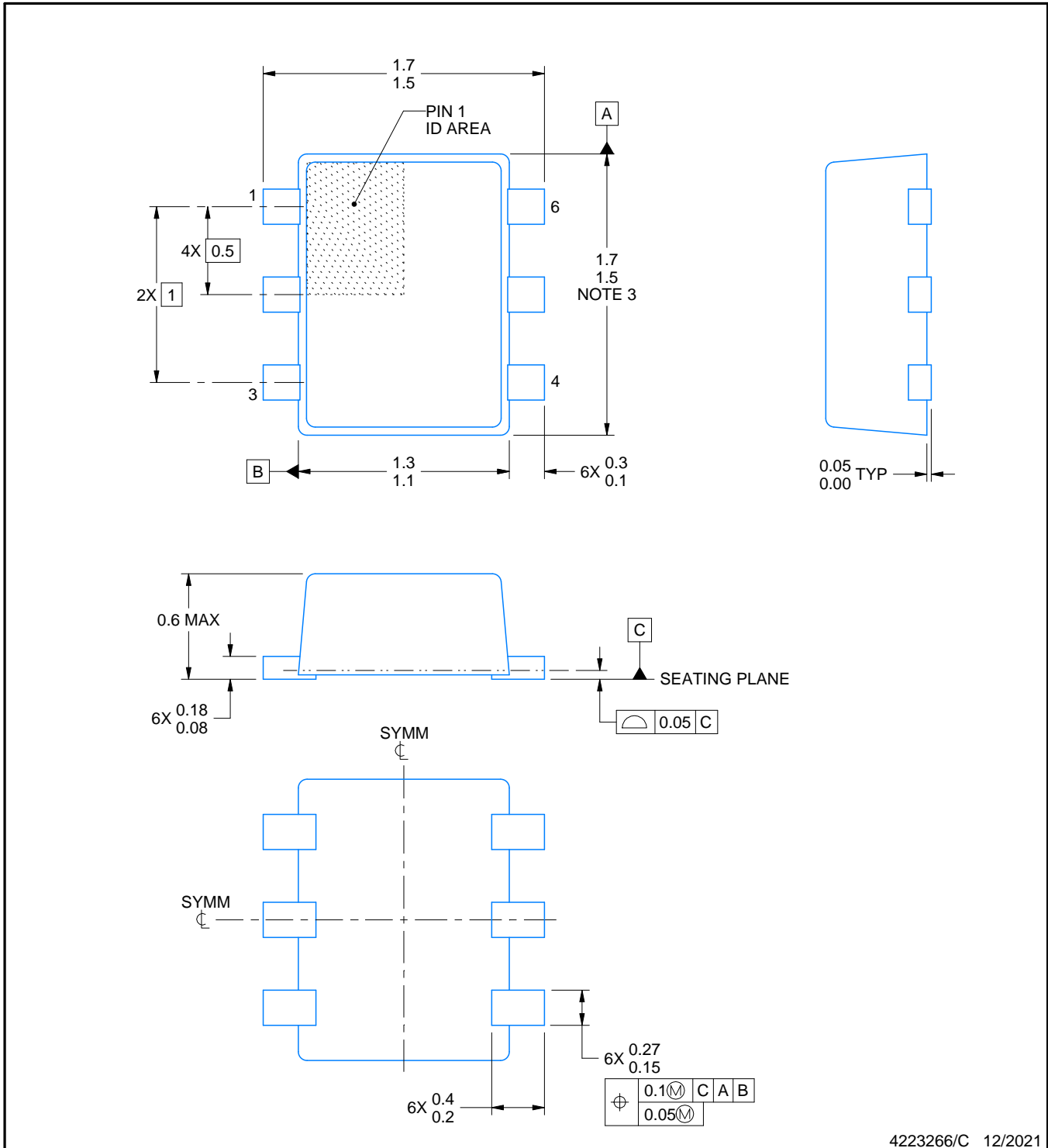

4223266/C 12/2021

### NOTES:

1. All linear dimensions are in millimeters. Any dimensions in parenthesis are for reference only. Dimensioning and tolerancing per ASME Y14.5M.
2. This drawing is subject to change without notice.
3. This dimension does not include mold flash, protrusions, or gate burrs. Mold flash, protrusions, or gate burrs shall not exceed 0.15 mm per side.
4. Reference JEDEC registration MO-293 Variation UAAD

# EXAMPLE BOARD LAYOUT

DRL0006A

SOT - 0.6 mm max height

PLASTIC SMALL OUTLINE

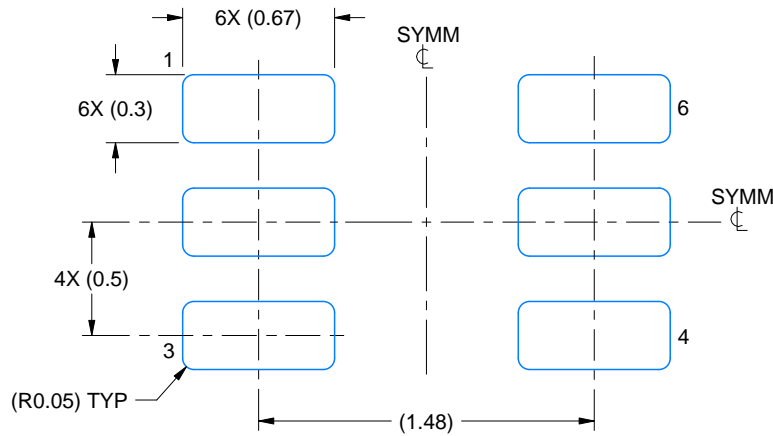

LAND PATTERN EXAMPLE  
SCALE:30X

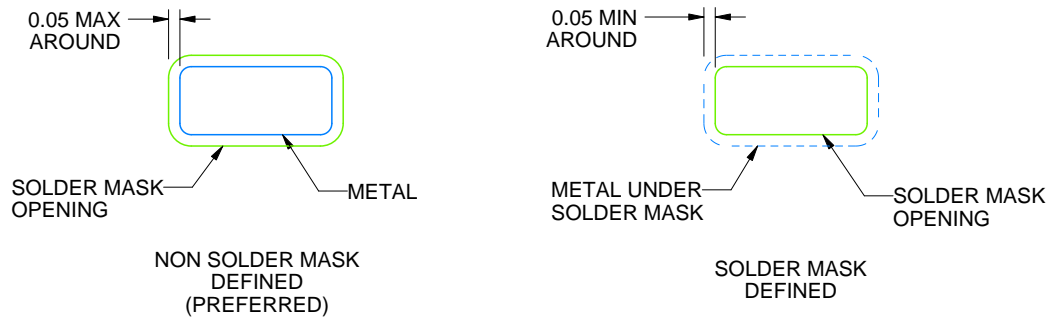

SOLDERMASK DETAILS

4223266/C 12/2021

NOTES: (continued)

5. Publication IPC-7351 may have alternate designs.
6. Solder mask tolerances between and around signal pads can vary based on board fabrication site.
7. Land pattern design aligns to IPC-610, Bottom Termination Component (BTC) solder joint inspection criteria.

# EXAMPLE STENCIL DESIGN

DRL0006A

SOT - 0.6 mm max height

PLASTIC SMALL OUTLINE

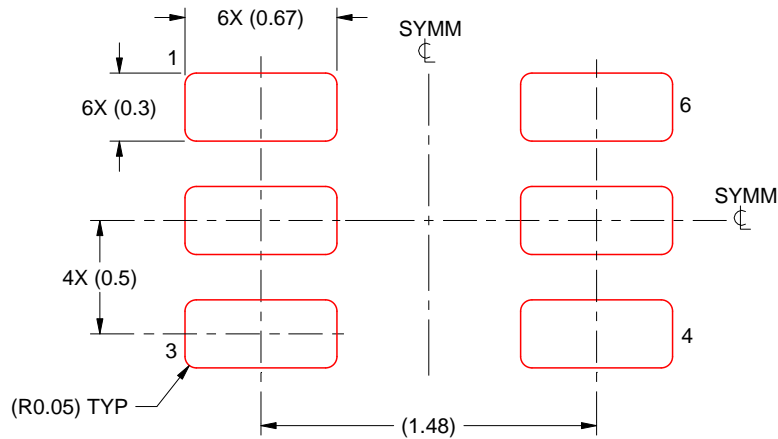

SOLDER PASTE EXAMPLE  
BASED ON 0.1 mm THICK STENCIL  
SCALE:30X

4223266/C 12/2021

NOTES: (continued)

8. Laser cutting apertures with trapezoidal walls and rounded corners may offer better paste release. IPC-7525 may have alternate design recommendations.
9. Board assembly site may have different recommendations for stencil design.

## IMPORTANT NOTICE AND DISCLAIMER

TI PROVIDES TECHNICAL AND RELIABILITY DATA (INCLUDING DATA SHEETS), DESIGN RESOURCES (INCLUDING REFERENCE DESIGNS), APPLICATION OR OTHER DESIGN ADVICE, WEB TOOLS, SAFETY INFORMATION, AND OTHER RESOURCES "AS IS" AND WITH ALL FAULTS, AND DISCLAIMS ALL WARRANTIES, EXPRESS AND IMPLIED, INCLUDING WITHOUT LIMITATION ANY IMPLIED WARRANTIES OF MERCHANTABILITY, FITNESS FOR A PARTICULAR PURPOSE OR NON-INFRINGEMENT OF THIRD PARTY INTELLECTUAL PROPERTY RIGHTS.

These resources are intended for skilled developers designing with TI products. You are solely responsible for (1) selecting the appropriate TI products for your application, (2) designing, validating and testing your application, and (3) ensuring your application meets applicable standards, and any other safety, security, regulatory or other requirements.

These resources are subject to change without notice. TI grants you permission to use these resources only for development of an application that uses the TI products described in the resource. Other reproduction and display of these resources is prohibited. No license is granted to any other TI intellectual property right or to any third party intellectual property right. TI disclaims responsibility for, and you will fully indemnify TI and its representatives against, any claims, damages, costs, losses, and liabilities arising out of your use of these resources.

TI's products are provided subject to [TI's Terms of Sale](#) or other applicable terms available either on [ti.com](https://www.ti.com) or provided in conjunction with such TI products. TI's provision of these resources does not expand or otherwise alter TI's applicable warranties or warranty disclaimers for TI products.

TI objects to and rejects any additional or different terms you may have proposed.

Mailing Address: Texas Instruments, Post Office Box 655303, Dallas, Texas 75265  
Copyright © 2024, Texas Instruments Incorporated

## Looking for pricing, stock, or lifecycle information?

Click below to explore more details on WIN SOURCE:

 [View SN74LVC2G34DBVR on WIN SOURCE](#)

 [Texas Instruments](#) Information

## Optimize Your Supply Chain with WIN SOURCE Solutions

-  Global Sourcing Solution
-  Obsolete Management
-  Cost Control Management
-  Shortage Management
-  Alternative Solution
-  Excess Inventory Management