



**THE DATASHEET OF
RCLAMP0521P.TCT**



PROTECTION PRODUCTS - RailClamp®
Description

RailClamp® TVS arrays are ultra low capacitance ESD protection devices designed to protect high speed data interfaces. This series has been specifically designed to protect sensitive components which are connected to high-speed data and transmission lines from overvoltage caused by ESD (electrostatic discharge), CDE (Cable Discharge Events), and EFT (electrical fast transients).

The RClamp®0521P has a maximum capacitance of only 0.50pF. This allows it to be used on circuits operating in excess of 3GHz without signal attenuation. They may be used to meet the ESD immunity requirements of IEC 61000-4-2, Level 4 ($\pm 15\text{kV}$ air, $\pm 8\text{kV}$ contact discharge).

The RClamp0521P is in a 2-pin SLP1006P2 package measuring 1.0 x 0.6 x 0.5mm. The leads are spaced at a pitch of 0.65mm and feature a lead-free finish. Each device will protect one high-speed line operating at 5 volts. It gives the designer the flexibility to protect single lines in applications where arrays are not practical. The combination of small size, low capacitance, and high ESD surge capability makes them ideal for use in applications such as cellular phones and digital video interfaces.

Features

- ◆ Transient protection for data lines to **IEC 61000-4-2 (ESD) $\pm 15\text{kV}$ (air), $\pm 8\text{kV}$ (contact)**
IEC 61000-4-4 (EFT) 40A (tp = 5/50ns)
Cable Discharge Event (CDE)
- ◆ Ultra-small package (1.0 x 0.6 x 0.5mm)
- ◆ Protects one data or I/O line
- ◆ Low capacitance: **0.5pF**
- ◆ Low clamping voltage
- ◆ Low operating voltage: 5.0V
- ◆ Solid-state silicon-avalanche technology

Mechanical Characteristics

- ◆ SLP1006P2 package
- ◆ Molding compound flammability rating: UL 94V-0
- ◆ Marking: Marking code
- ◆ Packaging: Tape and Reel
- ◆ Lead Finish: NiPdAu
- ◆ Pb-Free, Halogen Free, RoHS/WEEE Compliant

Applications

- ◆ Cellular Handsets & Accessories
- ◆ Digital Visual Interface (DVI)
- ◆ Display Port
- ◆ MDDI Ports
- ◆ USB Ports
- ◆ PCI Express
- ◆ Serial ATA

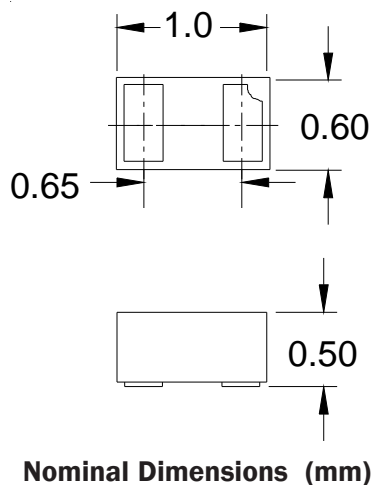
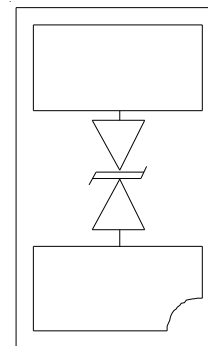
Dimensions

Schematic & Pin Configuration

SLP1006P2 (Bottom View)

PROTECTION PRODUCTS
Absolute Maximum Rating

Rating	Symbol	Value	Units
Peak Pulse Power (tp = 8/20μs)	P_{pk}	100	Watts
Maximum Peak Pulse Current (tp = 8/20μs)	I_{pp}	4	Amps
ESD per IEC 61000-4-2 (Air) ESD per IEC 61000-4-2 (Contact)	V_{ESD}	+/- 15 +/- 8	kV
Operating Temperature	T_J	-55 to +125	°C
Storage Temperature	T_{STG}	-55 to +150	°C

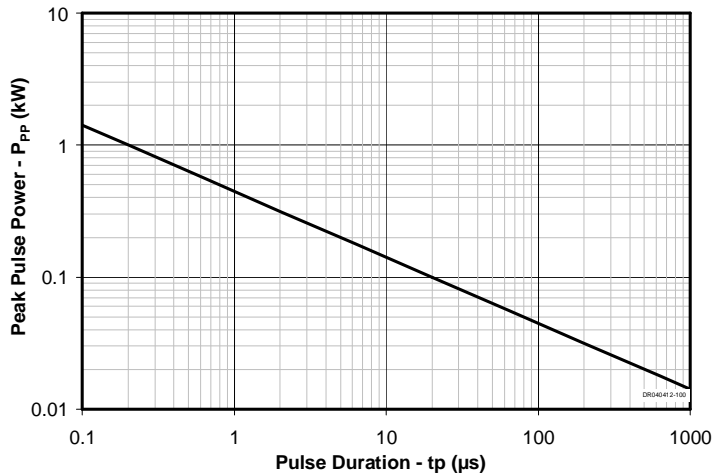
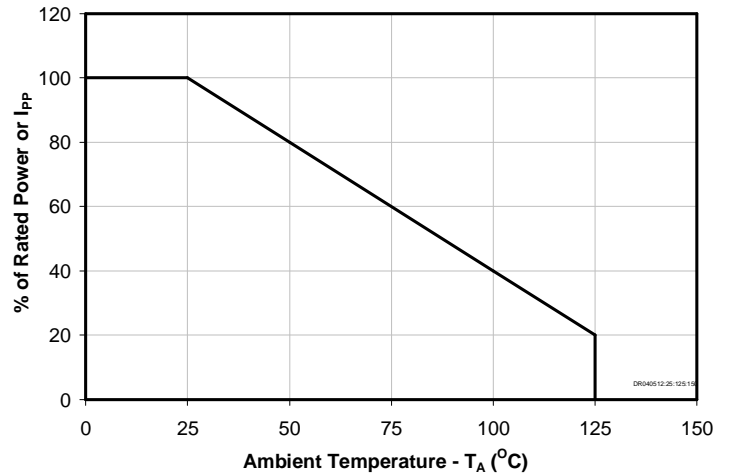
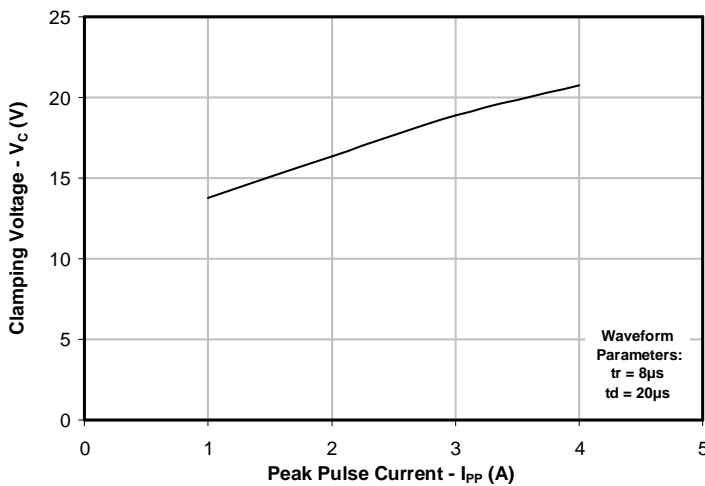
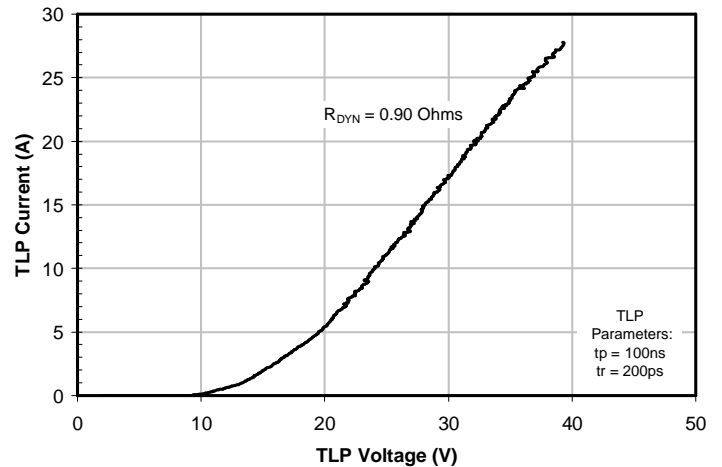
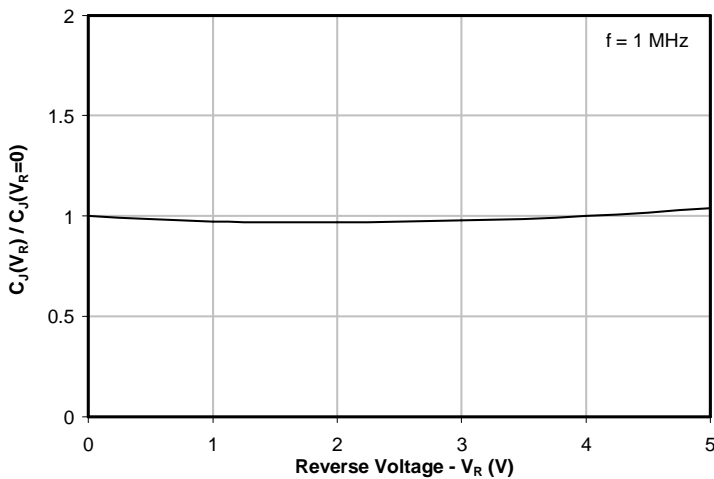
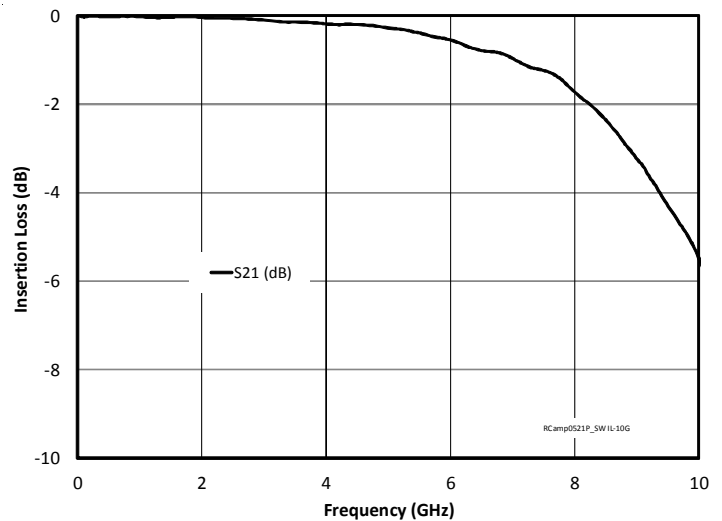
Electrical Characteristics (T=25°C)

Parameter	Symbol	Conditions	Minimum	Typical	Maximum	Units
Reverse Stand-Off Voltage	V_{RWM}				5	V
Reverse Breakdown Voltage	V_{BR}	$I_t = 1mA$	6	9.3	11	V
Reverse Leakage Current	I_R	$V_{RWM} = 5V, T=25°C$		0.025	1	μA
Clamping Voltage	V_C	$I_{pp} = 1A, tp = 8/20μs$			15	V
Clamping Voltage	V_C	$I_{pp} = 4A, tp = 8/20μs$			25	V
Junction Capacitance	C_J	$V_R = 0V, f = 1MHz$		0.30	0.50	pF

PROTECTION PRODUCTS
Typical Characteristics
Non-Repetitive Peak Pulse Power vs. Pulse Time

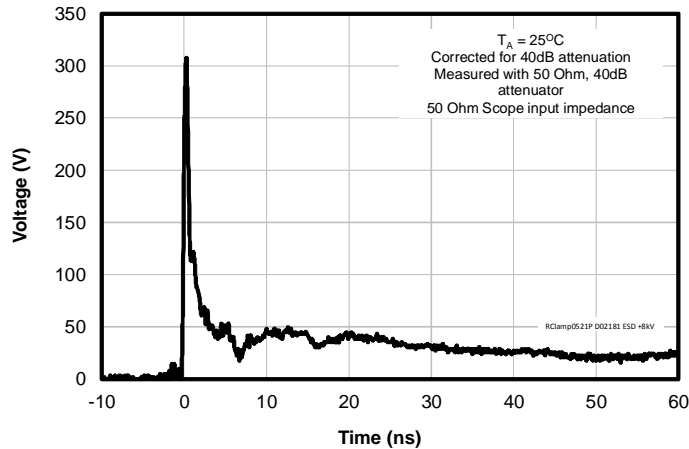
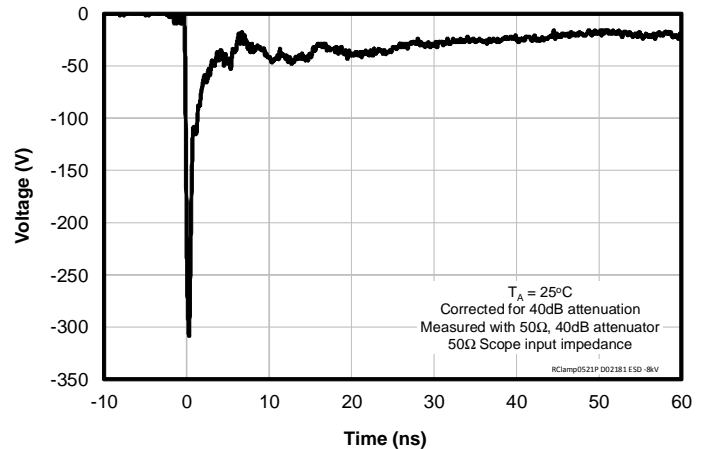
Power Derating Curve

Clamping Voltage vs. Peak Pulse Current

TLP Characteristic (Positive Pulse)

Normalized Capacitance vs. Reverse Voltage

Typical Insertion Loss (S21)

PROTECTION PRODUCTS
Typical Characteristics
ESD Clamping (+8kV Contact per IEC 61000-4-2)

ESD Clamping (-8kV Contact per IEC 61000-4-2)

Applications Information
Device Connection Options

These low capacitance TVS diodes are designed to provide common mode protection for one high-speed line or differential protection for one line pair. The device is bidirectional and may be used on lines where the signal polarity is positive and negative.

Circuit Board Layout Recommendations for Suppression of ESD.

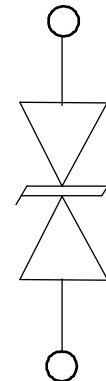
Good circuit board layout is critical for the suppression of ESD induced transients. The following guidelines are recommended:

- Place the TVS near the input terminals or connectors to restrict transient coupling.
- Minimize the path length between the TVS and the protected line.
- Minimize all conductive loops including power and ground loops.
- The ESD transient return path to ground should be kept as short as possible.
- Never run critical signals near board edges.
- Use ground planes whenever possible.

Equivalent Circuit Diagram

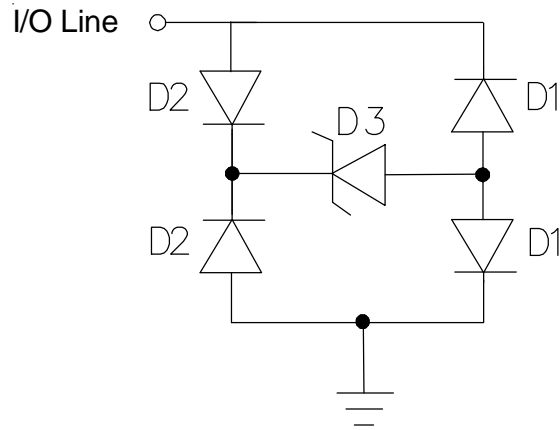
Applications Information - Spice Model

RClamp0521P Spice Model

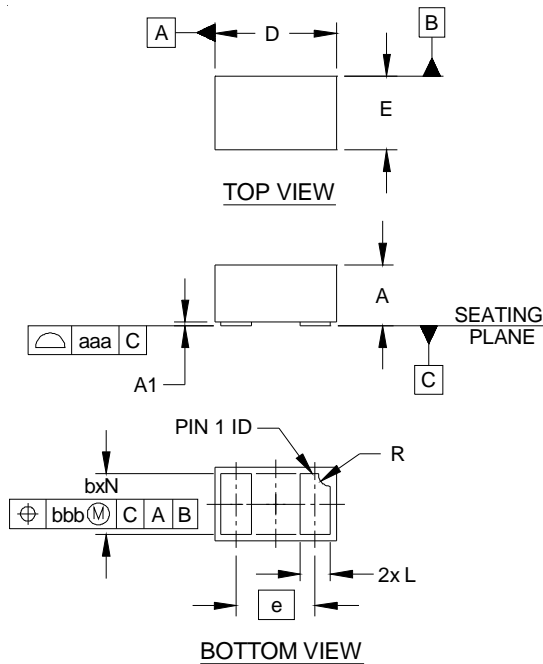
RClamp0521P Spice Parameters				
Parameter	Unit	D1 (LCRD)	D2 (LCRD)	D3 (TVS)
IS	Amp	1.0E-20	1.0E-20	2.0E-12
BV	Volt	100	100	9.36
VJ	Volt	0.7	0.7	0.6
RS	Ohm	0.458	0.89	0.8
IBV	Amp	1E-3	1E-3	1E-3
CJO	Farad	0.4E-12	0.4E-12	56E-12
TT	sec	2.541E-9	2.541E-9	2.541E-9
M	--	0.01	0.01	0.23
N	--	1.1	1.1	1.1
EG	eV	1.11	1.11	1.11

PROTECTION PRODUCTS
Outline Drawing - SLP1006P2

DIM	INCHES			MILLIMETERS		
	MIN	NOM	MAX	MIN	NOM	MAX
A	.016	.020	.022	0.40	0.50	0.55
A1	.000	.001	.002	0.00	0.03	0.05
b	.018	.020	.022	0.45	0.50	0.55
D	.035	.039	.043	0.90	1.00	1.10
E	.020	.024	.028	0.50	0.60	0.70
e	.026 BSC		.65 BSC			
L	.008	.010	.012	0.20	0.25	0.30
R	.002	.004	.006	0.05	0.10	0.15
N	2			2		
aaa	.003			0.08		
bbb	.004			0.10		

NOTES:

1. CONTROLLING DIMENSIONS ARE IN MILLIMETERS (ANGLES IN DEGREES).

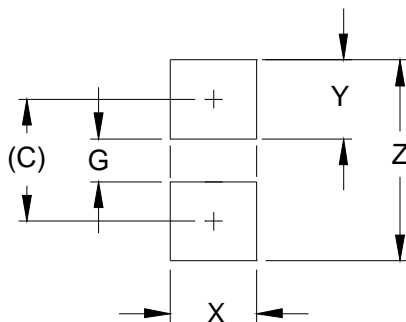
Land Pattern - SLP1006P2

DIM	DIMENSIONS	
	INCHES	MILLIMETERS
C	(.033)	(0.85)
G	.012	0.30
X	.024	0.60
Y	.022	0.55
Z	.055	1.40

NOTES:

1. CONTROLLING DIMENSIONS ARE IN MILLIMETERS (ANGLES IN DEGREES).
2. THIS LAND PATTERN IS FOR REFERENCE PURPOSES ONLY.
CONSULT YOUR MANUFACTURING GROUP TO ENSURE YOUR COMPANY'S MANUFACTURING GUIDELINES ARE MET.

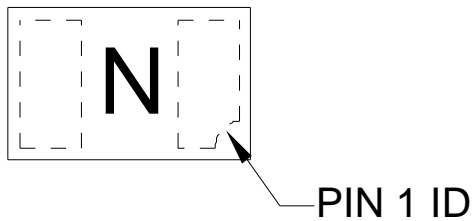
PROTECTION PRODUCTS
Marking Codes

Ordering Information

Part Number	Tape Pitch	Qty per Reel	Reel Size
RClamp0521P.TCT	4mm	3,000	7 Inch
RClamp0521P.TNT	2mm	10,000	7 Inch

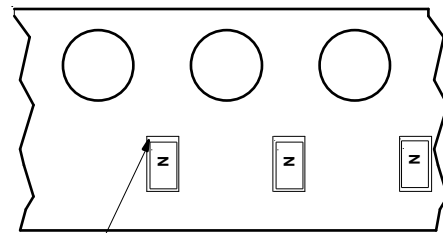
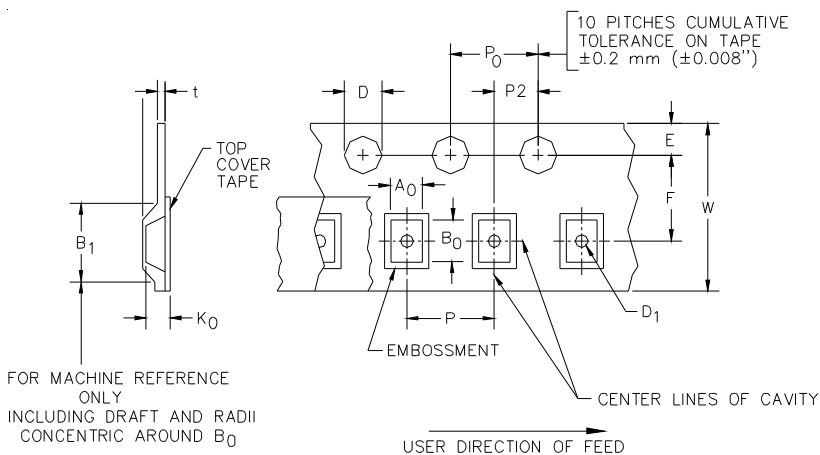
RailClamp and RClamp are marks of Semtech Corporation.

Carrier Tape Specification
3,000 piece, 4mm Pitch Reel

**Pin 1 Location
(Towards Sprocket Holes)**
Device Orientation in Tape

A0	B0	K0
0.69 +/-0.10 mm	1.19 +/-0.10 mm	0.66 +/-0.10 mm

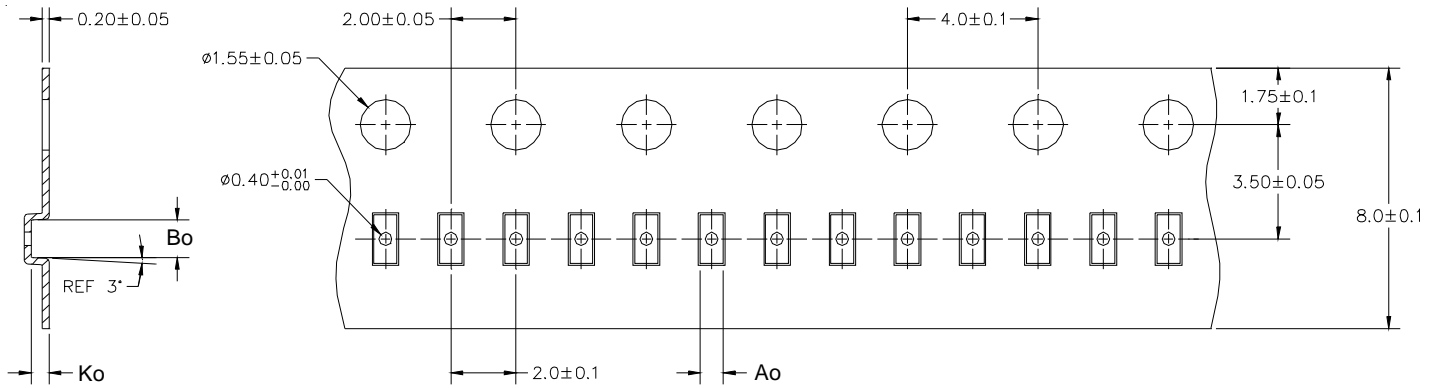
Tape Width	B, (Max)	D	D1	E	F	P	P0	P2	T	W
8 mm	4.2 mm (.165)	1.5 + 0.1 mm - 0.0 mm (0.59 +0.05 -.000)	0.4 mm ±0.25 (.031)	1.750±.10 mm (.069±.004)	3.5±0.05 mm (.138±.002)	4.0±0.10 mm (.157±.00- 4)	4.0±0.1 mm (.157±.00- 4)	2.0±0.05 mm (.079±.002)	0.254±0.02 mm (.016)	8.0 mm + 0.3 mm - 0.1 mm (.312±.012)

PROTECTION PRODUCTS
10,000 piece, 2mm Pitch Reel

A0	B0	K0
0.69 +/-0.10 mm	1.19 +/-0.10 mm	0.66 +/-0.10 mm

Note: All dimensions in mm unless otherwise specified

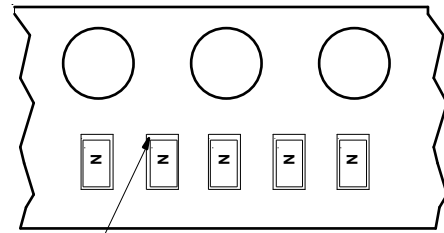



Pin 1 Location
(Towards Sprocket Holes)

Device Orientation in Tape
Contact Information

Semtech Corporation
 Protection Products Division
 200 Flynn Road, Camarillo, CA 93012
 Phone: (805)498-2111 FAX (805)498-3804

Looking for pricing, stock, or lifecycle information?

Click below to explore more details on WIN SOURCE:

-  [View RCLAMP0521P.TCT on WIN SOURCE](#)
-  [Semtech Corporation](#) Information

Optimize Your Supply Chain with WIN SOURCE Solutions

-  Global Sourcing Solution
-  Obsolete Management
-  Cost Control Management
-  Shortage Management
-  Alternative Solution
-  Excess Inventory Management