



# THE DATASHEET OF P0300SCLRP



### SIDActo<sup>®</sup> Protection Thyristor Series - DO-214



#### Agency Approvals

Agency	Agency File Number
	E133083

#### Schematic Symbol

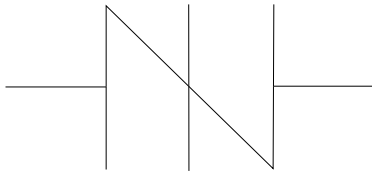

#### Description

SIDActo<sup>®</sup> Series DO-214AA are designed to protect baseband equipment such as modems, line cards, CPE and DSL from damaging overvoltage transients.

The series provides a surface mount solution that enables equipment to comply with global regulatory standards.

#### Features and Benefits

- Low voltage overshoot
- Low on-state voltage
- Does not degrade in capability after multiple surge events within limit.
- Low capacitance
- Fails short circuit when surged in excess of ratings
- Pb-free E3 means 2nd level interconnect is Pb-free and the terminal finish material is tin(Sn) (IPC/JEDEC J-STD-609A.01)
- UL Recognized to UL 497B as an Isolated Loop Circuit Protector

#### Applicable Global Standards

- TIA-968-A
- TIA-968-B
- ITU K.20/21 Enhanced Level\*
- ITU K.20/21 Basic Level
- GR 1089 Inter-building\*
- GR 1089 Intra-building
- IEC 61000-4-5 2nd Edition
- YD/T 1082
- YD/T 993
- YD/T 950

\*A/B-rated parts require series resistance

#### Electrical Characteristics

Part Number	Marking	$V_{DRM}$ @ $I_{DRM} = 5\mu A$	$V_S$ @ 100V/ $\mu s$	$I_H$	$I_S$	$I_T$	$V_T$ @ $I_T = 2.2$ Amps	Capacitance @ 1MHz, 2V bias	
		V min	V max	mA min	mA max	A max	V max	pF min	pF max
P0080SALRP	P-8A	6	25	50	800	2.2	4	20	35
P1200SALRP	P12A	100	130	120	800	2.2	4	15	40
P2000SALRP	P20A	180	220	120	800	2.2	4	15	35
P0220SALRP	P22A	15	32	50	800	2.2	4	20	40
P2500SALRP	P25A	230	290	120	800	2.2	4	15	35
P0300SALRP	P03A	25	40	50	800	2.2	4	15	40
P0640SALRP	P06A	58	77	150	800	2.2	4	15	40
P0720SALRP	P07A	65	88	150	800	2.2	4	15	40
P0900SALRP	P09A	75	98	150	800	2.2	4	15	40
P1100SALRP	P11A	90	130	150	800	2.2	4	15	40
P1300SALRP	P13A	120	160	150	800	2.2	4	15	40
P1500SALRP	P15A	140	180	150	800	2.2	4	15	40
P1800SALRP	P18A	170	220	150	800	2.2	4	15	35
P2100SALRP	P21A	180	240	150	800	2.2	4	15	35
P2300SALRP	P23A	190	260	150	800	2.2	4	15	35
P2600SALRP	P26A	220	300	150	800	2.2	4	15	35
P3100SALRP	P31A	275	350	150	800	2.2	4	15	35
P3500SALRP	P35A	320	400	150	800	2.2	4	15	35
P0080SBLRP	P-8B	6	25	50	800	2.2	4	20	50
P0220SBLRP	P22B	15	32	50	800	2.2	4	20	50
P0300SBLRP	P03B	25	40	50	800	2.2	4	15	50
P0640SBLRP	P06B	58	77	150	800	2.2	4	20	50
P0720SBLRP	P07B	65	88	150	800	2.2	4	20	50

### Electrical Parameters (continued)

Part Number	Marking	$V_{DRM}$ @ $I_{DRM}=5\mu A$	$V_S$ @ 100V/ $\mu s$	$I_H$	$I_S$	$I_T$	$V_T$ @ $I_T=2.2$ Amps	Capacitance @ 1MHz, 2V bias	
		V min	V max	mA min	mA max	A max	V max	pF min	pF max
P0900SBLRP	P09B	75	98	150	800	2.2	4	20	50
P1100SBLRP	P11B	90	130	150	800	2.2	4	20	50
P1200SBLRP	P12B	100	130	120	800	2.2	4	20	50
P1300SBLRP	P13B	120	160	150	800	2.2	4	20	50
P1500SBLRP	P15B	140	180	150	800	2.2	4	20	50
P1800SBLRP	P18B	170	220	150	800	2.2	4	20	50
P2000SBLRP	P20B	180	220	120	800	2.2	4	20	50
P2100SBLRP	P21B	180	240	150	800	2.2	4	20	35
P2300SBLRP	P23B	190	260	150	800	2.2	4	20	50
P2500SBLRP	P25B	230	290	120	800	2.2	4	20	50
P2600SBLRP	P26B	220	300	150	800	2.2	4	20	35
P3100SBLRP	P31B	275	350	150	800	2.2	4	20	35
P3500SBLRP	P35B	320	400	150	800	2.2	4	20	35
P4500SBLRP	P45B	400	530	150	800	2.2	4	20	50
P0080SCLRP	P-8C	6	25	50	800	2.2	4	25	70
P0220SCLRP	P22C	15	32	50	800	2.2	4	25	70
P0300SCLRP	P03C	25	40	50	800	2.2	4	20	50
P0640SCLRP	P06C	58	77	150	800	2.2	4	45	100
P0720SCLRP	P07C	65	88	150	800	2.2	4	45	100
P0900SCLRP	P09C	75	98	150	800	2.2	4	45	100
P1100SCLRP	P11C	90	130	150	800	2.2	4	45	90
P1200SCLRP	P12C	100	130	120	800	2.2	4	20	35
P1300SCLRP	P13C	120	160	150	800	2.2	4	40	85
P1500SCLRP	P15C	140	180	150	800	2.2	4	25	70
P1800SCLRP	P18C	170	220	150	800	2.2	4	25	70
P2000SCLRP	P20C	180	220	120	800	2.2	4	25	35
P2100SCLRP	P21C	180	240	150	800	2.2	4	25	70
P2300SCLRP	P23C	190	260	150	800	2.2	4	25	70
P2500SCLRP	P25C	230	290	120	800	2.2	4	30	70
P2600SCLRP	P26C	220	300	150	800	2.2	4	30	70
P3100SCLRP	P31C	275	350	150	800	2.2	4	30	70
P3500SCLRP	P35C	320	400	150	800	2.2	4	25	65
P4500SCLRP	P45C	400	530	150	800	2.2	4	25	65

**Notes:**

- Absolute maximum ratings measured at  $T_A=25^\circ C$  (unless otherwise noted).
- Components are bi-directional.

### Surge Ratings

Series	$I_{PP}$									$I_{TSM}$ 50/60 Hz	di/dt
	0.2/310 <sup>1</sup> 0.5/700 <sup>2</sup>	2/10 <sup>1</sup> 2/10 <sup>2</sup>	8/20 <sup>1</sup> 1.2/50 <sup>2</sup>	10/160 <sup>1</sup> 10/160 <sup>2</sup>	10/560 <sup>1</sup> 10/560 <sup>2</sup>	5/320 <sup>1</sup> 9/720 <sup>2</sup>	10/360 <sup>1</sup> 10/360 <sup>2</sup>	10/1000 <sup>1</sup> 10/1000 <sup>2</sup>	5/310 <sup>1</sup> 10/700 <sup>2</sup>		
	A min	A min	A min	A min	A min	A min	A min	A min	A min		
A	20	150	150	90	50	75	75	45	75	25	500
B	25	250	250	150	100	100	125	80	100	30	500
C	50	500	400	200	150	200	175	100	200	35	500

**Notes:**

- Current waveform in  $\mu s$
  - Voltage waveform in  $\mu s$
- Peak pulse current rating ( $I_{PP}$ ) is repetitive and guaranteed for the life of the product.
  - $I_{PP}$  ratings applicable over temperature range of  $-40^\circ C$  to  $+85^\circ C$
  - The component must initially be in thermal equilibrium with  $-40^\circ C \leq T_J \leq +150^\circ C$

**Thermal Considerations**

Package	Symbol	Parameter	Value	Unit
DO-214AA 	$T_J$	Operating Junction Temperature Range	-40 to +150	°C
	$T_S$	Storage Temperature Range	-65 to +150	°C
	$R_{\theta JA}$	Thermal Resistance: Junction to Ambient	90	°C/W

**V-I Characteristics**



**$t_r \times t_d$  Pulse Waveform**

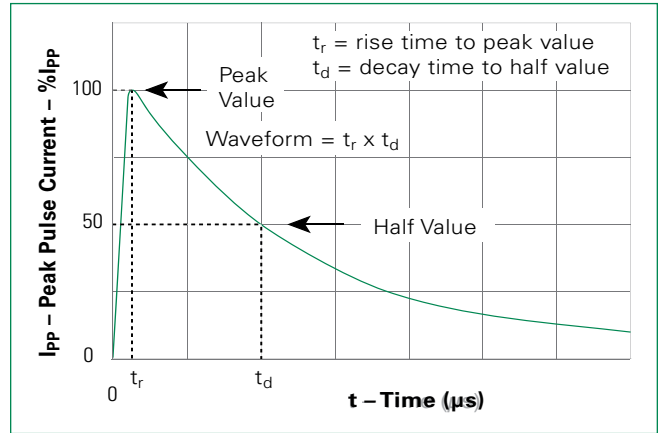

**Normalized  $V_S$  Change vs. Junction Temperature**

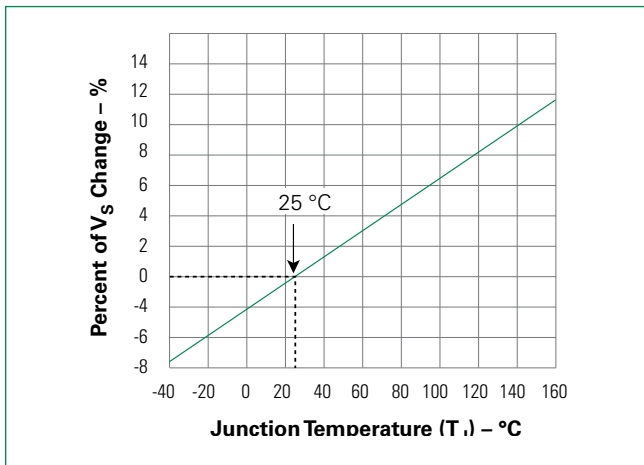

**Normalized DC Holding Current vs. Case Temperature**

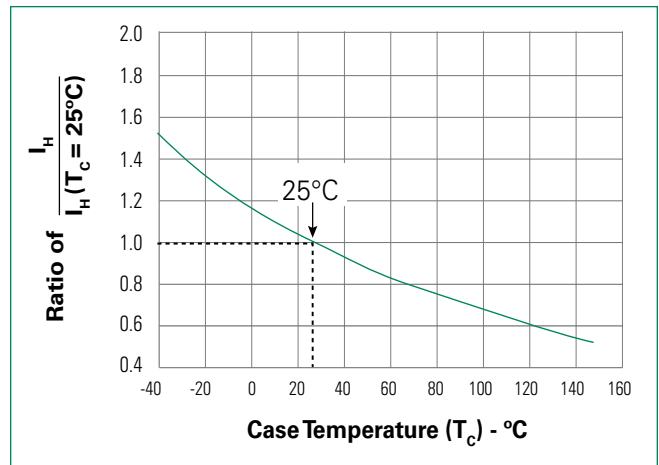

**Soldering Parameters**

<b>Reflow Condition</b>		Pb-Free assembly
<b>Pre Heat</b>	- Temperature Min ( $T_{s(min)}$ )	+150°C
	- Temperature Max ( $T_{s(max)}$ )	+200°C
	- Time (Min to Max) ( $t_s$ )	60-180 secs.
<b>Average ramp up rate (Liquidus Temp (<math>T_L</math>) to peak)</b>		3°C/sec. Max.
<b><math>T_{s(max)}</math> to <math>T_L</math> - Ramp-up Rate</b>		3°C/sec. Max.
<b>Reflow</b>	- Temperature ( $T_L$ ) (Liquidus)	+217°C
	- Temperature ( $t_L$ )	60-150 secs.
<b>Peak Temp (<math>T_p</math>)</b>		+260(+0/-5)°C
<b>Time within 5°C of actual Peak Temp (<math>t_p</math>)</b>		30 secs. Max.
<b>Ramp-down Rate</b>		6°C/sec. Max.
<b>Time 25°C to Peak Temp (<math>T_p</math>)</b>		8 min. Max.
<b>Do not exceed</b>		+260°C

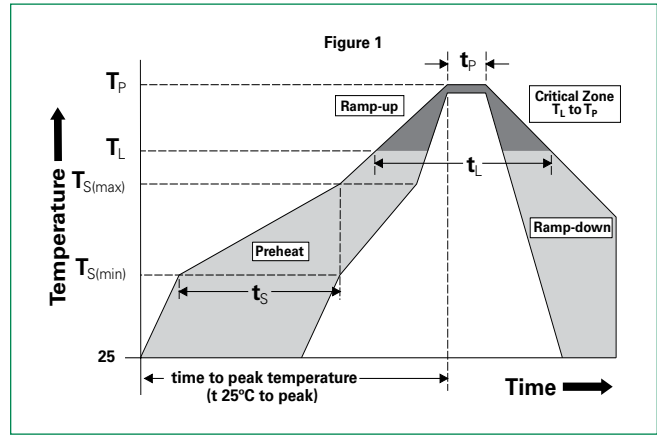

**Physical Specifications**

<b>Lead Material</b>	Copper Alloy
<b>Terminal Finish</b>	100% Matte-Tin Plated
<b>Body Material</b>	UL recognized epoxy meeting flammability classification V-0

**Environmental Specifications**

<b>High Temp Voltage Blocking</b>	80% Rated $V_{DRM}$ ( $V_{AC}$ Peak) +125°C or +150°C, 504 or 1008 hrs. MIL-STD-750 (Method 1040) JEDEC, JESD22-A-101
<b>Temp Cycling</b>	-65°C to +150°C, 15 min. dwell, 10 up to 100 cycles. MIL-STD-750 (Method 1051) EIA/JEDEC, JESD22-A104
<b>Biased Temp &amp; Humidity</b>	52 $V_{DC}$ (+85°C) 85% RH, 504 up to 1008 hrs. EIA/JEDEC, JESD22-A-101
<b>High Temp Storage</b>	+150°C 1008 hrs. MIL-STD-750 (Method 1031) JEDEC, JESD22-A-101
<b>Low Temp Storage</b>	-65°C, 1008 hrs.
<b>Thermal Shock</b>	0°C to +100°C, 5 min. dwell, 10 sec. transfer, 10 cycles. MIL-STD-750 (Method 1056) JEDEC, JESD22-A-106
<b>Autoclave (Pressure Cooker Test)</b>	+121°C, 100% RH, 2atm, 24 up to 168 hrs. EIA/JEDEC, JESD22-A-102
<b>Resistance to Solder Heat</b>	+260°C, 30 secs. MIL-STD-750 (Method 2031)
<b>Moisture Sensitivity Level</b>	85% RH, +85°C, 168 hrs., 3 reflow cycles (+260°C Peak). JEDEC-J-STD-020, Level 1

**Part Numbering**

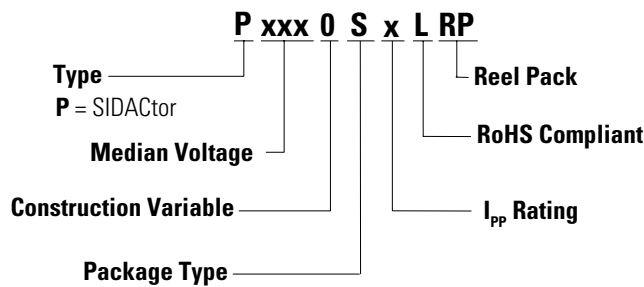

**Part Marking**

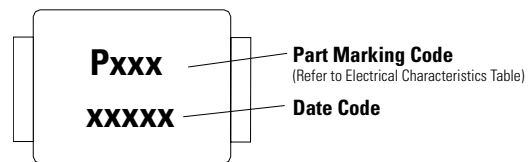

**Dimensions — DO-214AA**

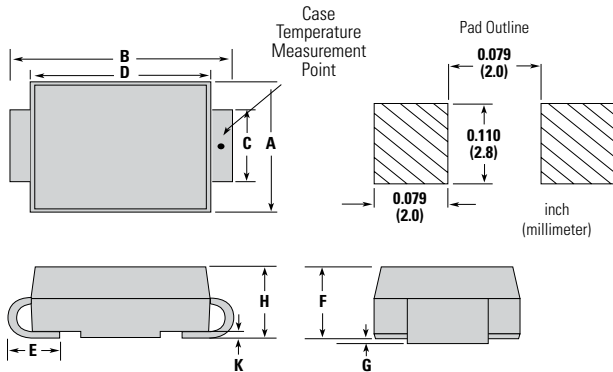

Dimensions	Inches		Millimeters	
	Min	Max	Min	Max
A	0.130	0.156	3.30	3.95
B	0.201	0.220	5.10	5.60
C	0.077	0.087	1.95	2.20
D	0.159	0.181	4.05	4.60
E	0.030	0.063	0.75	1.60
F	0.075	0.096	1.90	2.45
G	0.002	0.008	0.05	0.20
H	0.077	0.104	1.95	2.65
K	0.006	0.016	0.15	0.41

**Packing Options**

Package Type	Description	Quantity	Added Suffix	Industry Standard
S	DO-214AA Tape & Reel Pack	2500	RP	EIA-481-D

**Tape and Reel Specification — DO-214AA**

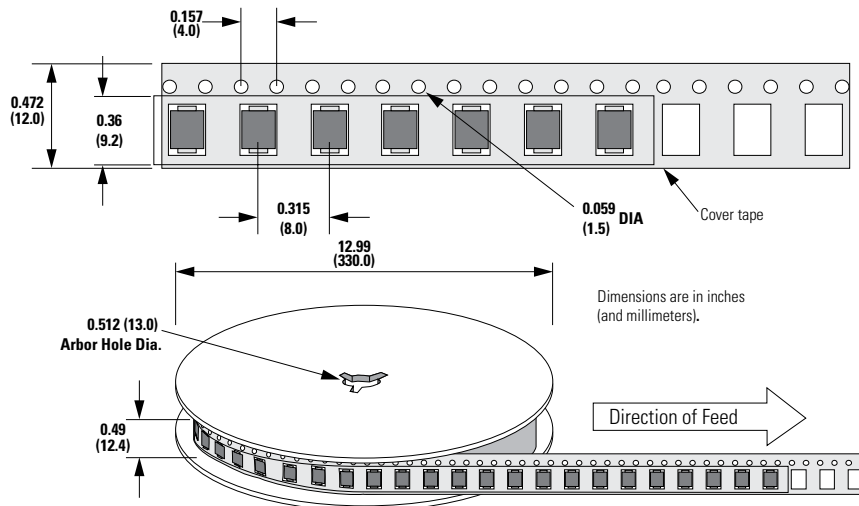

## Looking for pricing, stock, or lifecycle information?

Click below to explore more details on WIN SOURCE:

 [View P0300SCLRP on WIN SOURCE](#)

 [Littelfuse Inc. Information](#)

## Optimize Your Supply Chain with WIN SOURCE Solutions

-  Global Sourcing Solution
-  Obsolete Management
-  Cost Control Management
-  Shortage Management
-  Alternative Solution
-  Excess Inventory Management