



**THE DATASHEET OF
NC7WZ14EP6X**



NC7WZ14

TinyLogic UHS Dual Inverter with Schmitt Trigger Inputs

Description

The NC7WZ14 is a dual inverter with Schmitt trigger input from ON Semiconductor's Ultra-High Speed (UHS) Series of TinyLogic. The device is fabricated with advanced CMOS technology to achieve ultra-high speed with high output drive while maintaining low static power dissipation over a very broad V_{CC} operating range. The device is specified to operate over the 1.65 V to 5.5 V V_{CC} range. The inputs and outputs are high-impedance when V_{CC} is 0 V. Inputs tolerate voltages up to 5.5 V independent of V_{CC} operating voltage. Schmitt trigger inputs achieve typically 1 V hysteresis between the positive-and negative-going input threshold voltage at 5 V.

Features

- Ultra High-Speed: t_{PD} 3.2 ns (Typical) into 50 pF at 5 V
- High Output Drive: ± 24 mA at 3 V V_{CC}
- Broad V_{CC} Operating Range: 1.65 V to 5.5 V
- Matches Performance of LCX when Operated at 3.3 V V_{CC}
- Power Down High Impedance Inputs / Outputs
- Over-Voltage Tolerance Inputs Facilitate 5 V to 3 V Translation
- Proprietary Noise / EMI Reduction Circuitry
- Ultra-Small MicroPak™ Packages
- Space-Saving SC70 Package
- These Devices are Pb-Free, Halogen Free/BFR Free and are RoHS Compliant

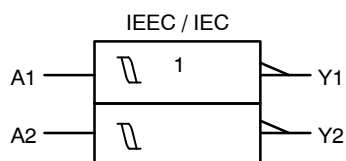

Figure 1. Logic Symbol



ON Semiconductor®

www.onsemi.com

MARKING DIAGRAMS



SIP6 1.45x1.0
CASE 127EB

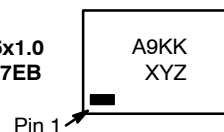

UDFN6
1.0x1.0, 0.35P
CASE 517DP

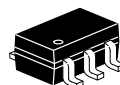
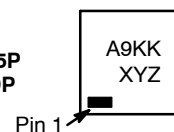

SC-88
(SC-70 6 Lead)
1.25x2
CASE 419AD-01

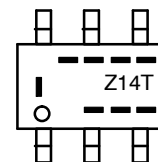

A9, Z14 = Specific Device Code
 KK = 2-Digit Lot Run Traceability Code
 XY = 2-Digit Date Code Format
 Z = Assembly Plant Code
 - - - - = Year Coding Scheme
 | - - = Plant Code Identifier
 T = Die Run Code
 - - - = Eight-Week Datacoding Scheme

ORDERING INFORMATION

See detailed ordering, marking and shipping information in the package dimensions section on page 6 of this data sheet.

NC7WZ14

Pin Configurations

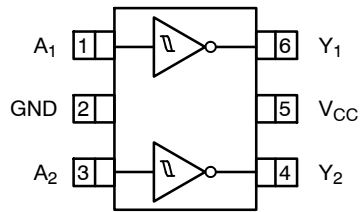

Figure 2. SC70 (Top View)

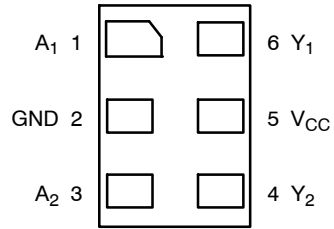
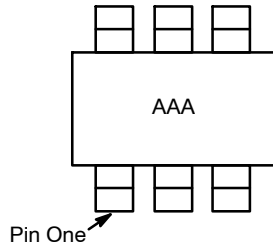

Figure 3. MicroPak (Top Through View)



NOTES:

1. AAA represents Product Code Top Mark (see *Ordering Information*).
2. Orientation of Top Mark determines Pin One location. Read the top mark left to right, pin one is the lower left pin.

Figure 4. SC70 Pin 1 Orientation

PIN DEFINITIONS

Pin # SC70	Pin # MicroPak	Name	Description
1	1	A ₁	Input
2	2	GND	Ground
3	3	A ₂	Input
4	4	Y ₂	Output
5	5	V _{CC}	Supply Voltage
6	6	Y ₁	Input

FUNCTION TABLE (Y = /A)

Input	Output
A	Y
L	H
H	L

H = HIGH Logic Level
L = LOW Logic Level

NC7WZ14

ABSOLUTE MAXIMUM RATINGS

Symbol	Parameter		Min	Max	Unit
V _{CC}	Supply Voltage		-0.5	6.5	V
V _{IN}	DC Input Voltage		-0.5	6.5	V
V _{OUT}	DC Output Voltage		-0.5	6.5	V
I _{IK}	DC Input Diode Current	V _{IN} < -0.5 V	-	-50	mA
I _{OK}	DC Output Diode Current	V _{OUT} < -0.5 V	-	-50	mA
I _{OUT}	DC Output Current		-	±100	mA
I _{CC} or I _{GND}	DC V _{CC} or Ground Current		-	±50	mA
T _{STG}	Storage Temperature Range		-65	+150	°C
T _J	Junction Temperature Under Bias		-	+150	°C
T _L	Junction Lead Temperature (Soldering, 10 Seconds)		-	+260	°C
P _D	Power Dissipation	SC70-6	-	190	mW
		MicroPak-6	-	327	
		MicroPak2™-6	-	327	
ESD	Human Body Model, JEDEC: JESD22-A114		-	4000	V
	Charge Device Model, JEDEC: JESD22-C101		-	2000	

Stresses exceeding those listed in the Maximum Ratings table may damage the device. If any of these limits are exceeded, device functionality should not be assumed, damage may occur and reliability may be affected.

RECOMMENDED OPERATING CONDITIONS

Symbol	Parameter	Conditions	Min	Max	Unit
V _{CC}	Supply Voltage Operating		1.65	5.50	V
	Supply Voltage Data Retention		1.5	5.5	
V _{IN}	Input Voltage		0	5.5	V
V _{OUT}	Output Voltage		0	V _{CC}	V
T _A	Operating Temperature	SC70-6	-40	+125	°C
		MicroPak-6	-40	+85	
		MicroPak2-6	-40	+85	
θ _{JA}	Thermal Resistance	SC70-6	-	659	°C/W
		MicroPak-6	-	382	
		MicroPak2-6	-	382	

Functional operation above the stresses listed in the Recommended Operating Ranges is not implied. Extended exposure to stresses beyond the Recommended Operating Ranges limits may affect device reliability.

3. Unused inputs must be held HIGH or LOW. They may not float.

DC ELECTRICAL CHARACTERISTICS

Symbol	Parameter	V _{CC} (V)	Conditions	T _A = +25°C			T _A = -40 to +85°C		T _A = -40 to +125°C		Unit
				Min	Typ	Max	Min	Max	Min	Max	
V _P	Positive Threshold Voltage	1.65		-	-	1.40	-	1.40	-	1.40	V
		1.80		-	-	1.50	-	1.50	-	1.50	
		2.30		-	-	1.80	-	1.80	-	1.80	
		3.00		-	-	2.20	-	2.20	-	2.20	
		4.50		-	-	3.10	-	3.10	-	3.20	
		5.50		-	-	3.60	-	3.60	-	3.70	

NC7WZ14

DC ELECTRICAL CHARACTERISTICS (continued)

Symbol	Parameter	V _{CC} (V)	Conditions	T _A = +25°C			T _A = -40 to +85°C		T _A = -40 to +125°C		Unit	
				Min	Typ	Max	Min	Max	Min	Max		
V _N	Negative Threshold Voltage	1.65		0.20	0.50	-	0.20	-	0.30	-	V	
		1.80		0.25	0.56	-	0.25	-	0.35	-		
		2.30		0.40	0.75	-	0.40	-	0.50	-		
		3.00		0.60	0.98	-	0.60	-	0.70	-		
		4.50		1.00	1.42	-	1.00	-	1.10	-		
		5.50		1.20	1.68	-	1.20	-	1.40	-		
V _H	Hysteresis Voltage	1.65		0.10	0.48	0.90	0.10	0.90	0.10	0.90	V	
		1.80		0.15	0.51	1.00	0.15	1.00	0.15	1.00		
		2.30		0.25	0.62	1.10	0.25	1.10	0.25	1.10		
		3.00		0.40	0.76	1.20	0.40	1.20	0.40	1.20		
		4.50		0.60	1.01	1.50	0.60	1.50	0.60	1.50		
		5.50		0.70	1.20	1.70	0.70	1.70	0.70	1.70		
V _{OH}	HIGH Level Output Voltage	1.65	V _{IN} = V _{IL} , I _{OH} = -100 μA	1.55	1.65	-	1.55	-	1.55	-	V	
		1.80		1.70	1.80	-	1.70	-	1.70	-		
		2.30		2.20	2.30	-	2.20	-	2.20	-		
		3.00		2.90	3.00	-	2.90	-	2.90	-		
		4.50		4.40	4.50	-	4.40	-	4.40	-		
		1.65	I _{OH} = -4 mA	1.29	1.52	-	1.29	-	1.26	-		
		2.30		I _{OH} = -8 mA	1.90	2.14	-	1.90	-	1.80		-
		3.00		I _{OH} = -16 mA	2.40	2.75	-	2.40	-	2.30		-
		3.00		I _{OH} = -24 mA	2.30	2.62	-	2.30	-	2.20		-
		4.50		I _{OH} = -32 mA	3.80	4.13	-	3.80	-	3.70		-
V _{OL}	LOW Level Output Voltage	1.65	V _{IN} = V _{IH} , I _{OL} = 100 μA	-	0.00	0.10	-	0.10	-	0.10	V	
		1.80		-	0.00	0.10	-	0.10	-	0.10		
		2.30		-	0.00	0.10	-	0.10	-	0.10		
		3.00		-	0.00	0.10	-	0.10	-	0.10		
		4.50		-	0.00	0.10	-	0.10	-	0.10		
		1.65	I _{OL} = 4 mA	-	0.08	0.24	-	0.24	-	0.26		
		2.30		I _{OL} = 8 mA	-	0.10	0.30	-	0.30	-		0.32
		3.00		I _{OL} = 16 mA	-	0.16	0.40	-	0.40	-		0.43
		3.00		I _{OL} = 24 mA	-	0.24	0.55	-	0.55	-		0.60
		4.50		I _{OL} = 32 mA	-	0.25	0.55	-	0.55	-		0.60
		4.50		I _{OL} = 32 mA	-	0.25	0.55	-	0.55	-		0.60
I _{IN}	Input Leakage Current	1.65 to 5.5	V _{IN} = 5.5 V, GND	-	-	±0.1	-	±1.0	-	±2.0	μA	
I _{OFF}	Power Off Leakage Current	0	V _{IN} or V _{OUT} = 5.5 V	-	-	1	-	10	-	20	μA	
I _{CC}	Quiescent Supply Current	1.65 to 5.5	V _{IN} = 5.5 V, GND	-	-	1.0	-	10	-	20	μA	

AC ELECTRICAL CHARACTERISTICS

Symbol	Parameter	V _{CC} (V)	Conditions	T _A = +25°C			T _A = -40 to +85°C		T _A = -40 to +125°C		Unit
				Min	Typ	Max	Min	Max	Min	Max	
t _{PLH} , t _{PHL}	Propagation Delay (Figure 5, 6)	1.65	C _L = 15 pF, R _L = 1 MΩ,	-	7.6	13.1	-	14.5	-	14.7	ns
		1.80		-	6.3	10.9	-	12.0	-	12.3	
		2.50 ±0.20		-	4.3	7.4	-	8.1	-	8.4	
		3.30 ±0.30	-	3.3	5.0	-	5.5	-	5.8		
		5.00 ±0.50	-	2.7	4.1	-	4.5	-	4.8		
		3.30 ±0.30	C _L = 50 pF, R _L = 500 Ω,	-	4.0	6.0	-	6.6	-	6.9	
		5.00 ±0.50		-	3.2	4.9	-	5.4	-	5.7	
C _{IN}	Input Capacitance	0.00		-	2.5	-	-	-	-	pF	
C _{PD}	Power Dissipation Capacitance (Note 4) (Figure 7)	3.30		-	11.0	-	-	-	-	pF	
		5.00		-	12.5	-	-	-	-		

4. C_{PD} is defined as the value of the internal equivalent capacitance which is derived from dynamic operating current consumption (I_{CCD}) at no output loading and operating at 50% duty cycle. C_{PD} is related to I_{CCD} dynamic operating current by the expression:
I_{CCD} = (C_{PD}) (V_{CC}) (f_{IN}) + (I_{CCstatic}).

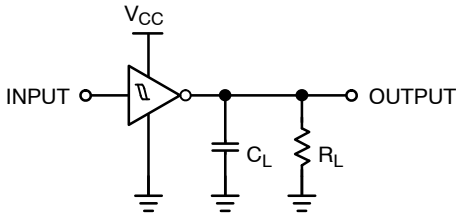

NOTE:
5. C_L includes load and stray capacitance;
Inputs PRR = 1.0 MHz, t_W = 500 ns.

Figure 5. AC Test Circuit

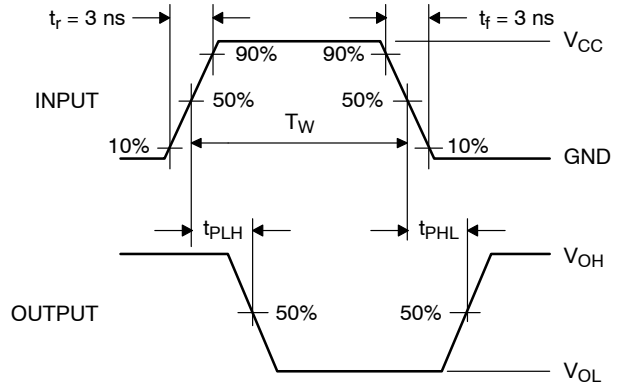
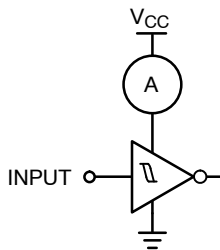

Figure 6. AC Waveforms



NOTE:
6. Input = AC Waveform; t_r = t_f = 1.8 ns; PRR = variable;
Duty Cycle = 50%.

Figure 7. I_{CCD} Test Circuit

NC7WZ14

ORDERING INFORMATION

Device	Operating Temperature	Top Mark	Packages	Shipping [†]
NC7WZ14P6X	-40 to +85°C	Z14	6-Lead SC70, EIAJ SC-88a, 1.25 mm Wide	3000 / Tape & Reel
NC7WZ14EP6X	-40 to +125°C	Z14	6-Lead SC70, EIAJ SC-88a, 1.25 mm Wide	3000 / Tape & Reel
NC7WZ14L6X	-40 to +85°C	A9	6-Lead MicroPak, 1.00 mm Wide	5000 / Tape & Reel
NC7WZ14FHX	-40 to +85°C	A9	6-Lead, MicroPak2, 1x1 mm Body, .35 mm Pitch	5000 / Tape & Reel

[†]For information on tape and reel specifications, including part orientation and tape sizes, please refer to our Tape and Reel Packaging Specifications Brochure, BRD8011/D.

MicroPak and MicroPak2 are trademarks of Semiconductor Components Industries, LLC (SCILLC) or its subsidiaries in the United States and/or other countries.

MECHANICAL CASE OUTLINE

PACKAGE DIMENSIONS

ON Semiconductor®



SIP6 1.45X1.0
CASE 127EB
ISSUE O

DATE 31 AUG 2016

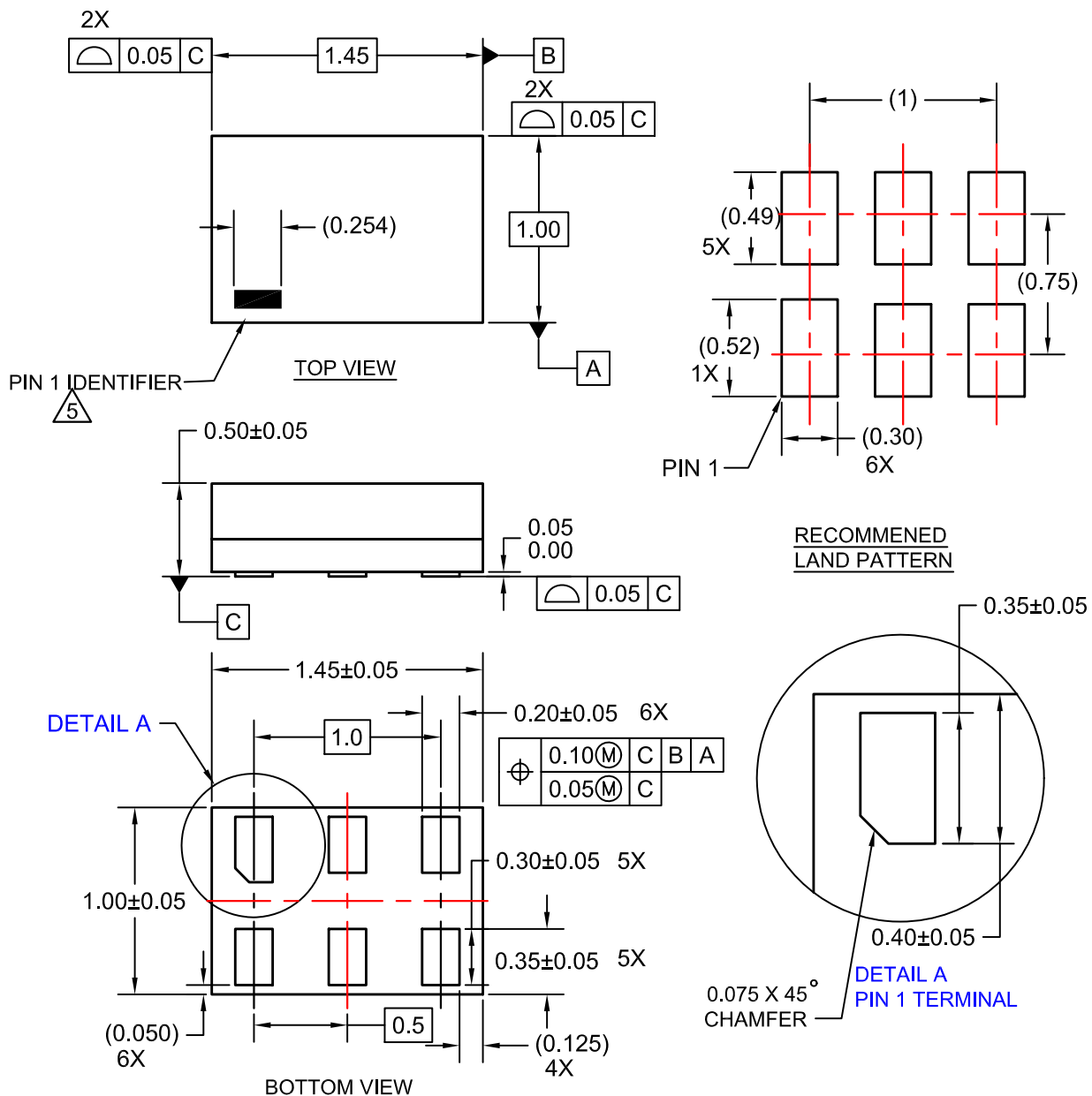

NOTES:

1. CONFORMS TO JEDEC STANDARD MO-252 VARIATION UAAD
2. DIMENSIONS ARE IN MILLIMETERS
3. DRAWING CONFORMS TO ASME Y14.5M-2009
4. PIN ONE IDENTIFIER IS 2X LENGTH OF ANY OTHER LINE IN THE MARK CODE LAYOUT.

DOCUMENT NUMBER:	98AON13590G	Electronic versions are uncontrolled except when accessed directly from the Document Repository. Printed versions are uncontrolled except when stamped "CONTROLLED COPY" in red.
STATUS:	ON SEMICONDUCTOR STANDARD	
NEW STANDARD:		
DESCRIPTION:	SIP6 1.45X1.0	PAGE 1 OF 2

MECHANICAL CASE OUTLINE

PACKAGE DIMENSIONS

ON Semiconductor®



SC-88 (SC-70 6 Lead), 1.25x2
CASE 419AD-01
ISSUE A

DATE 07 JUL 2010

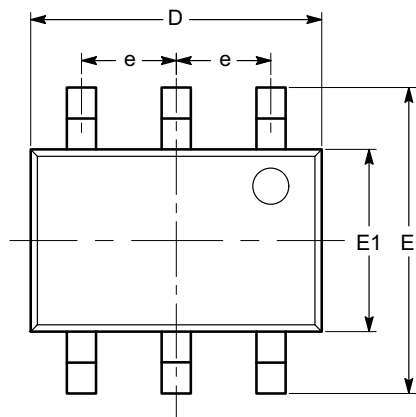

TOP VIEW

SYMBOL	MIN	NOM	MAX
A	0.80		1.10
A1	0.00		0.10
A2	0.80		1.00
b	0.15		0.30
c	0.10		0.18
D	1.80	2.00	2.20
E	1.80	2.10	2.40
E1	1.15	1.25	1.35
e	0.65 BSC		
L	0.26	0.36	0.46
L1	0.42 REF		
L2	0.15 BSC		
θ	0°		8°
θ_1	4°		10°

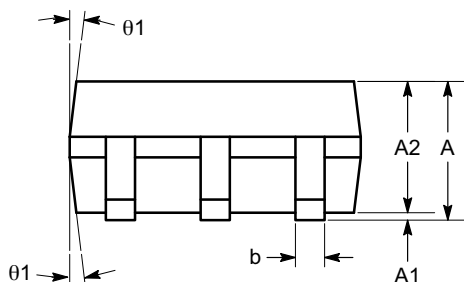

SIDE VIEW

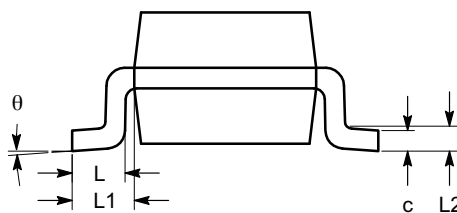

END VIEW

Notes:

- (1) All dimensions are in millimeters. Angles in degrees.
- (2) Complies with JEDEC MO-203.

DOCUMENT NUMBER:	98AON34266E	Electronic versions are uncontrolled except when accessed directly from the Document Repository. Printed versions are uncontrolled except when stamped "CONTROLLED COPY" in red.
STATUS:	ON SEMICONDUCTOR STANDARD	
REFERENCE:		
DESCRIPTION:	SC-88 (SC-70 6 LEAD), 1.25X2	PAGE 1 OF 2

MECHANICAL CASE OUTLINE
PACKAGE DIMENSIONS

ON Semiconductor®



UDFN6 1.0X1.0, 0.35P
CASE 517DP
ISSUE O

DATE 31 AUG 2016

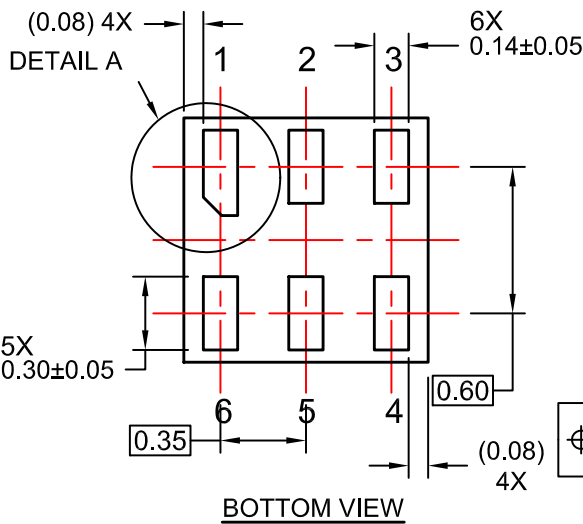
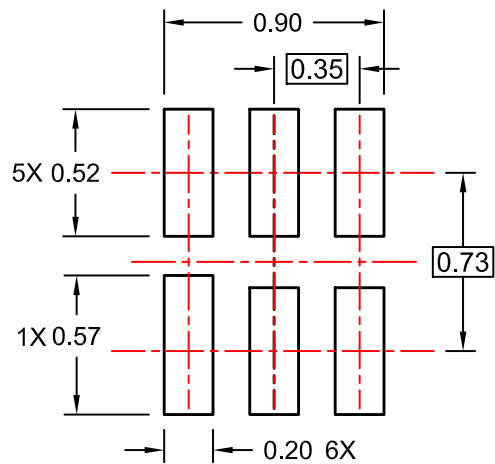
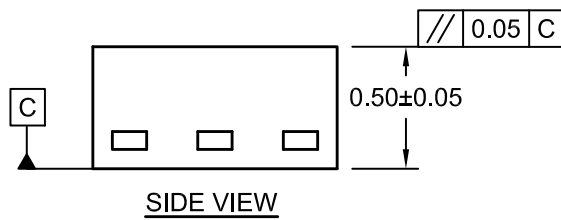
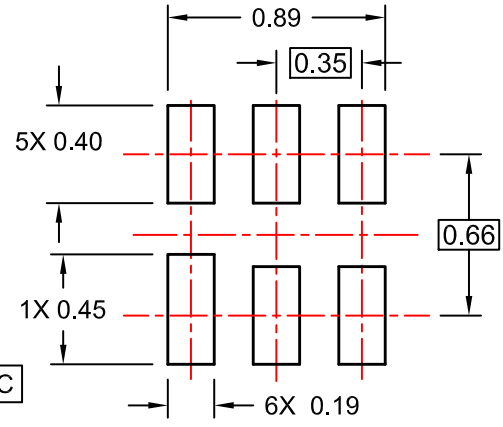
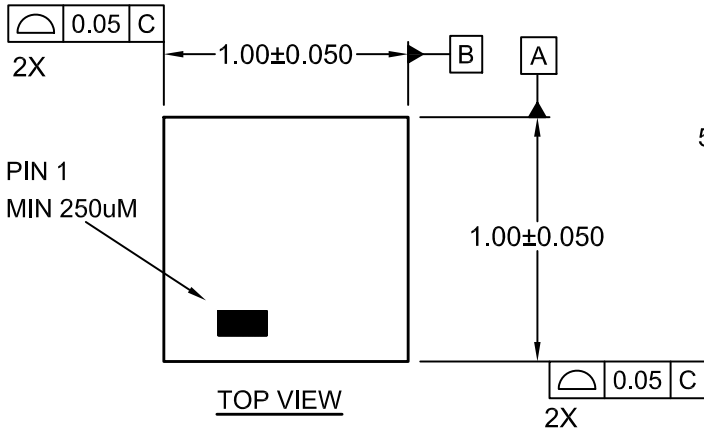

ALTERNATIVE LAND PATTERN FOR UNIVERSAL APPLICATION

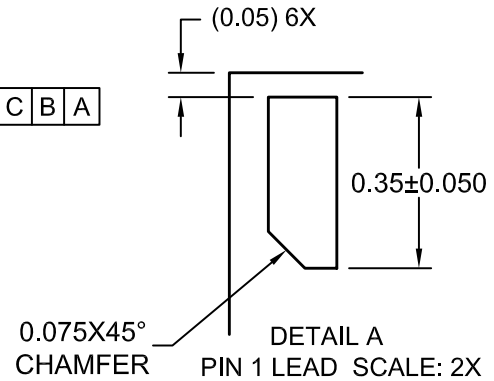

- NOTES:
A. COMPLIES TO JEDEC MO-252 STANDARD
B. DIMENSIONS ARE IN MILLIMETERS.
C. DIMENSIONS AND TOLERANCES PER ASME Y14.5M, 2009

DOCUMENT NUMBER:	98AON13593G	Electronic versions are uncontrolled except when accessed directly from the Document Repository. Printed versions are uncontrolled except when stamped "CONTROLLED COPY" in red.
STATUS:	ON SEMICONDUCTOR STANDARD	
NEW STANDARD:		
DESCRIPTION:	UDFN6 1.0X1.0, 0.35P	PAGE 1 OF 2

ON Semiconductor and  are trademarks of Semiconductor Components Industries, LLC dba ON Semiconductor or its subsidiaries in the United States and/or other countries. ON Semiconductor owns the rights to a number of patents, trademarks, copyrights, trade secrets, and other intellectual property. A listing of ON Semiconductor's product/patent coverage may be accessed at www.onsemi.com/site/pdf/Patent-Marking.pdf. ON Semiconductor reserves the right to make changes without further notice to any products herein. ON Semiconductor makes no warranty, representation or guarantee regarding the suitability of its products for any particular purpose, nor does ON Semiconductor assume any liability arising out of the application or use of any product or circuit, and specifically disclaims any and all liability, including without limitation special, consequential or incidental damages. Buyer is responsible for its products and applications using ON Semiconductor products, including compliance with all laws, regulations and safety requirements or standards, regardless of any support or applications information provided by ON Semiconductor. "Typical" parameters which may be provided in ON Semiconductor data sheets and/or specifications can and do vary in different applications and actual performance may vary over time. All operating parameters, including "Typicals" must be validated for each customer application by customer's technical experts. ON Semiconductor does not convey any license under its patent rights nor the rights of others. ON Semiconductor products are not designed, intended, or authorized for use as a critical component in life support systems or any FDA Class 3 medical devices or medical devices with a same or similar classification in a foreign jurisdiction or any devices intended for implantation in the human body. Should Buyer purchase or use ON Semiconductor products for any such unintended or unauthorized application, Buyer shall indemnify and hold ON Semiconductor and its officers, employees, subsidiaries, affiliates, and distributors harmless against all claims, costs, damages, and expenses, and reasonable attorney fees arising out of, directly or indirectly, any claim of personal injury or death associated with such unintended or unauthorized use, even if such claim alleges that ON Semiconductor was negligent regarding the design or manufacture of the part. ON Semiconductor is an Equal Opportunity/Affirmative Action Employer. This literature is subject to all applicable copyright laws and is not for resale in any manner.

PUBLICATION ORDERING INFORMATION

LITERATURE FULFILLMENT:

Literature Distribution Center for ON Semiconductor
19521 E. 32nd Pkwy, Aurora, Colorado 80011 USA
Phone: 303-675-2175 or 800-344-3860 Toll Free USA/Canada
Fax: 303-675-2176 or 800-344-3867 Toll Free USA/Canada
Email: orderlit@onsemi.com

N. American Technical Support: 800-282-9855 Toll Free
USA/Canada
Europe, Middle East and Africa Technical Support:
Phone: 421 33 790 2910

ON Semiconductor Website: www.onsemi.com

Order Literature: <http://www.onsemi.com/orderlit>

For additional information, please contact your local
Sales Representative

Looking for pricing, stock, or lifecycle information?

Click below to explore more details on WIN SOURCE:

-  [View NC7WZ14EP6X on WIN SOURCE](#)
-  [Fairchild/ON Semiconductor](#) Information

Optimize Your Supply Chain with WIN SOURCE Solutions

-  Global Sourcing Solution
-  Obsolete Management
-  Cost Control Management
-  Shortage Management
-  Alternative Solution
-  Excess Inventory Management