



**THE DATASHEET OF  
MSQA6V1W5T2G**



# MSQA6V1W5T2G, SZMSQA6V1W5T2G

## ESD Protection Diode Array

### Low Clamping Voltage

This quad monolithic silicon voltage suppressor is designed for applications requiring transient overvoltage protection capability. It is intended for use in voltage and ESD sensitive equipment such as computers, printers, business machines, communication systems, medical equipment, and other applications. Its quad junction common anode design protects four separate lines using only one package. These devices are ideal for situations where board space is at a premium.

#### Features

- Low Clamping Voltage
- Stand Off Voltage 3 V
- Low Leakage < 1  $\mu$ A @ 3 V
- SC-88A Package Allows Four Separate Unidirectional Configurations
- IEC1000-4-2 Level 4 ESD Protection
- SZ Prefix for Automotive and Other Applications Requiring Unique Site and Control Change Requirements; AEC-Q101 Qualified and PPAP Capable
- Pb-Free Package is Available\*

#### Mechanical Characteristics:

- Void Free, Transfer-Molded, Thermosetting Plastic Case
- Corrosion Resistant Finish, Easily Solderable
- Package Designed for Optimal Automated Board Assembly
- Small Package Size for High Density Applications

\*For additional information on our Pb-Free strategy and soldering details, please download the ON Semiconductor Soldering and Mounting Techniques Reference Manual, SOLDERRM/D.



ON Semiconductor®

[www.onsemi.com](http://www.onsemi.com)

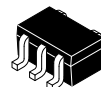

SCALE 2:1

SC-88A/SOT-323  
CASE 419A

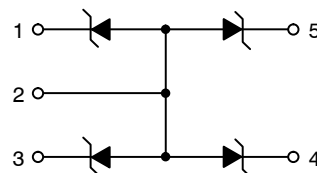

#### MARKING DIAGRAM

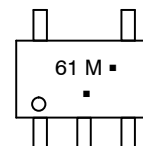

61 = Device Code  
M = Date Code  
▪ = Pb-Free Package

(Note: Microdot may be in either location)

#### ORDERING INFORMATION

Device	Package	Shipping†
MSQA6V1W5T2G	SC-88A (Pb-Free)	3,000 / Tape & Reel
SZMSQA6V1W5T2G	SC-88A (Pb-Free)	3,000 / Tape & Reel

†For information on tape and reel specifications, including part orientation and tape sizes, please refer to our Tape and Reel Packaging Specification Brochure, BRD8011/D.

\*T2 Suffix Devices are Packaged with Pin 1 Opposing Sprocket Hole.

# MSQA6V1W5T2G, SZMSQA6V1W5T2G

## MAXIMUM RATINGS

Rating	Symbol	Value	Unit
Peak Power Dissipation @ 20 $\mu$ s @ $T_A \leq 25^\circ\text{C}$ (Note 1)	$P_{pk}$	150	W
Steady State Power – 1 Diode (Note 2)	$P_D$	385	mW
Thermal Resistance Junction-to-Ambient Above $25^\circ\text{C}$ , Derate	$R_{\theta JA}$	325 3.1	$^\circ\text{C/W}$ mW/ $^\circ\text{C}$
Maximum Junction Temperature	$T_{Jmax}$	150	$^\circ\text{C}$
Operating Junction and Storage Temperature Range	$T_J T_{stg}$	-55 to +150	$^\circ\text{C}$
ESD Discharge MIL STD 883C – Method 3015-6 IEC1000-4-2, Air Discharge IEC1000-4-2, Contact Discharge	$V_{PP}$	16 16 9	kV
Lead Solder Temperature (10 s duration)	$T_L$	260	$^\circ\text{C}$

Stresses exceeding those listed in the Maximum Ratings table may damage the device. If any of these limits are exceeded, device functionality should not be assumed, damage may occur and reliability may be affected.

1. Non-repetitive current per Figure 5. Derate per Figure 10.
  2. Only 1 diode under power. For all 4 diodes under power,  $P_D$  will be 25%. Mounted on FR-4 board with min pad.
- See Application Note AND8308/D for further description of survivability specs.

## ELECTRICAL CHARACTERISTICS

( $T_A = 25^\circ\text{C}$  unless otherwise noted)

Symbol	Parameter
$I_{PP}$	Maximum Reverse Peak Pulse Current
$V_C$	Clamping Voltage @ $I_{PP}$
$V_{RWM}$	Working Peak Reverse Voltage
$I_R$	Maximum Reverse Leakage Current @ $V_{RWM}$
$V_{BR}$	Breakdown Voltage @ $I_T$
$I_T$	Test Current
$I_F$	Forward Current
$V_F$	Forward Voltage @ $I_F$
$P_{pk}$	Peak Power Dissipation
C	Capacitance @ $V_R = 0$ and $f = 1.0$ MHz

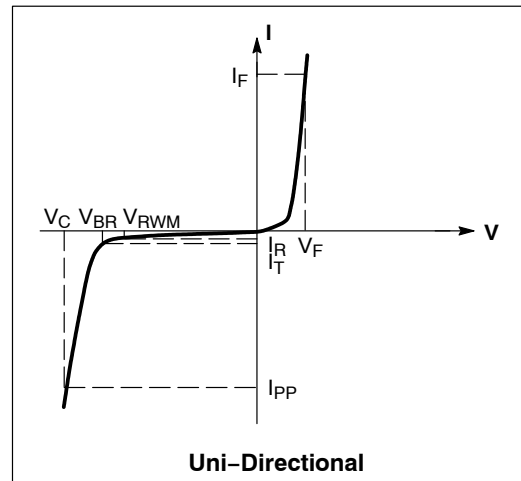

\*See Application Note AND8308/D for detailed explanations of datasheet parameters.

## ELECTRICAL CHARACTERISTICS

Device*	Breakdown Voltage $V_{BR}$ @ 1 mA ( $V_o$ ) (Note 3)			Leakage Current $I_{RM}$ @ $V_{RWM} = 3$ V ( $\mu\text{A}$ )	Capacitance @ 0 V Bias (pF)	Max $V_F$ @ $I_F = 200$ mA (V)	$V_C$
	Min	Nom	Max				Per IEC61000-4-2 (Note 4)
MSQA6V1W5T2G	6.1	6.6	7.2	1.0	90	1.25	Figures 1 and 2 See Below

3.  $V_{BR}$  is measured with a pulse test current  $I_T$  at an ambient temperature of  $25^\circ\text{C}$ .

4. For test procedure see Figures 3 and 4 and Application Note AND8307/D.

\*Include SZ-prefix devices where applicable.

# MSQA6V1W5T2G, SZMSQA6V1W5T2G

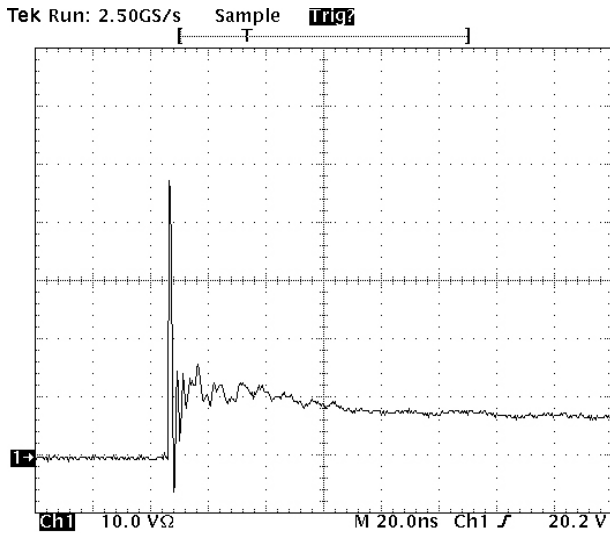

Figure 1. ESD Clamping Voltage Screenshot Positive 8 kV Contact per IEC61000-4-2

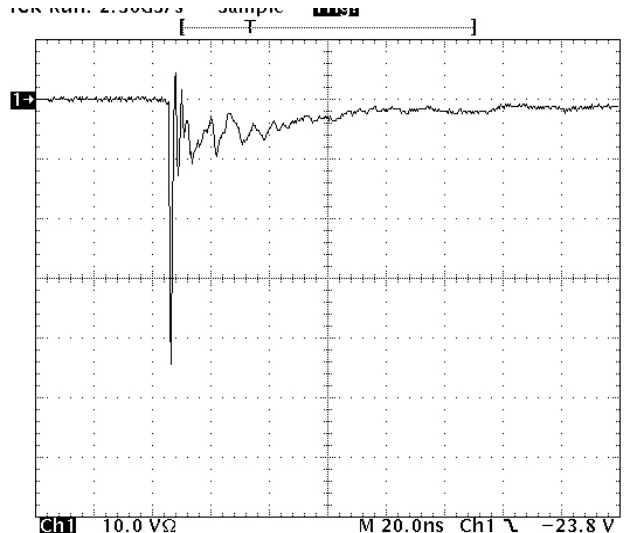

Figure 2. ESD Clamping Voltage Screenshot Negative 8 kV Contact per IEC61000-4-2

## IEC 61000-4-2 Spec.

Level	Test Voltage (kV)	First Peak Current (A)	Current at 30 ns (A)	Current at 60 ns (A)
1	2	7.5	4	2
2	4	15	8	4
3	6	22.5	12	6
4	8	30	16	8

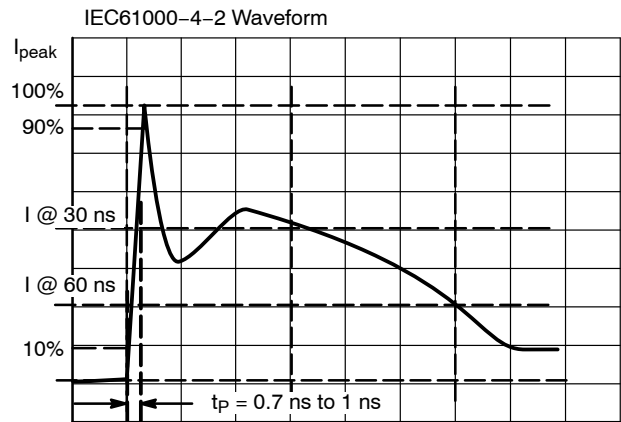

Figure 3. IEC61000-4-2 Spec

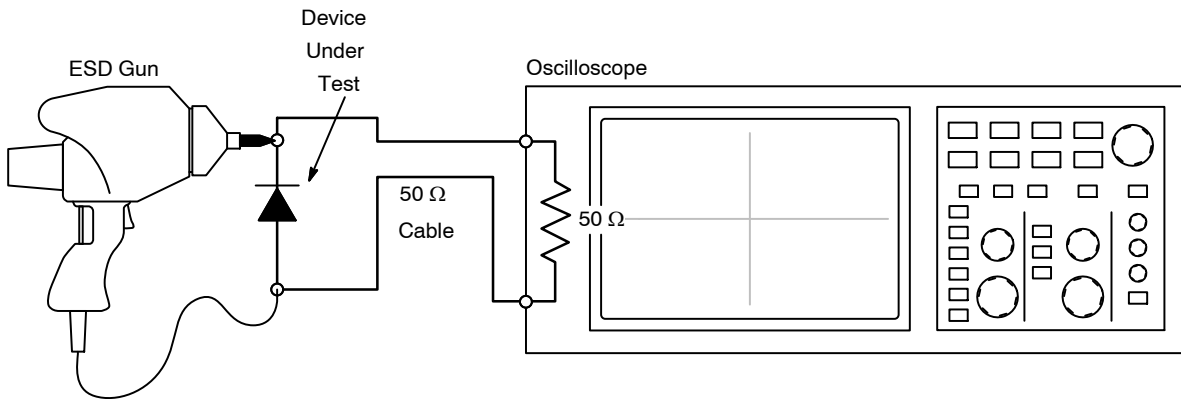

Figure 4. Diagram of ESD Test Setup

## MSQA6V1W5T2G, SZMSQA6V1W5T2G

The following is taken from Application Note  
AND8308/D – Interpretation of Datasheet Parameters  
for ESD Devices.

### ESD Voltage Clamping

For sensitive circuit elements it is important to limit the voltage that an IC will be exposed to during an ESD event to as low a voltage as possible. The ESD clamping voltage is the voltage drop across the ESD protection diode during an ESD event per the IEC61000-4-2 waveform. Since the IEC61000-4-2 was written as a pass/fail spec for larger

systems such as cell phones or laptop computers it is not clearly defined in the spec how to specify a clamping voltage at the device level. ON Semiconductor has developed a way to examine the entire voltage waveform across the ESD protection diode over the time domain of an ESD pulse in the form of an oscilloscope screenshot, which can be found on the datasheets for all ESD protection diodes. For more information on how ON Semiconductor creates these screenshots and how to interpret them please refer to AND8307/D.

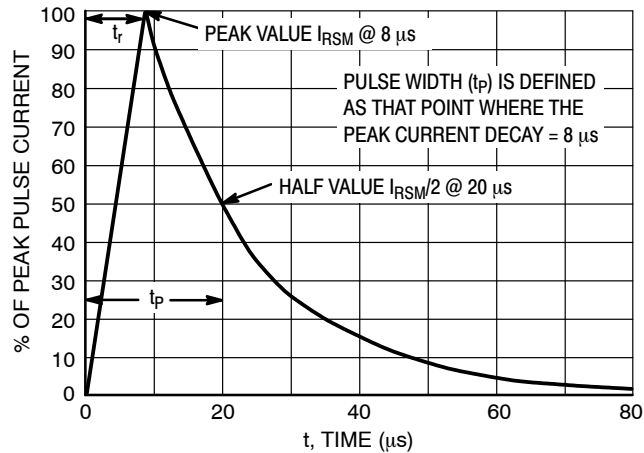

Figure 5. 8 x 20 μs Pulse Waveform

# MSQA6V1W5T2G, SZMSQA6V1W5T2G

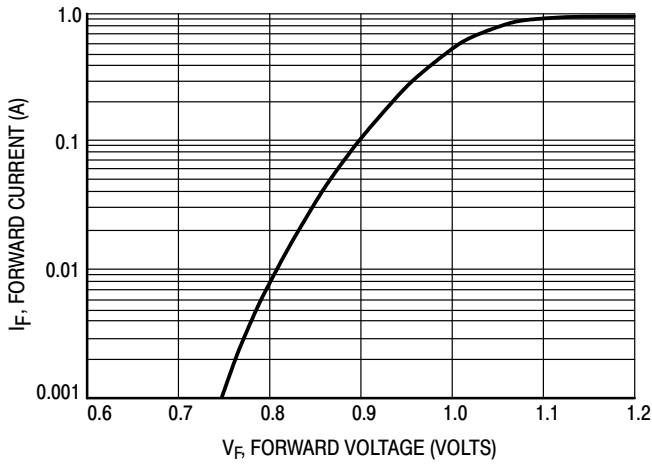

Figure 6. Forward Voltage

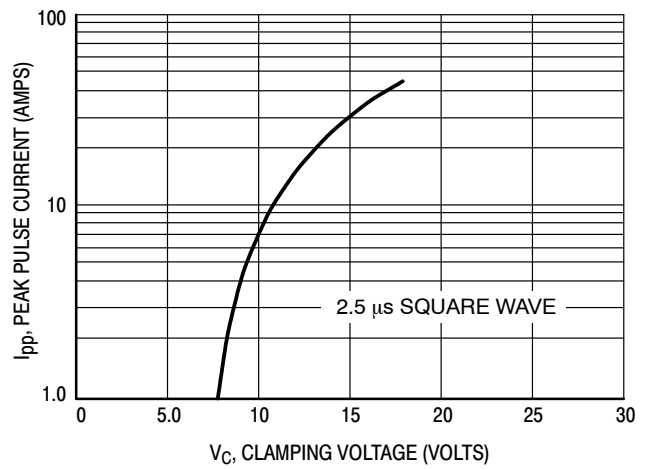

Figure 7. Clamping Voltage versus Peak Pulse Current (Reverse Direction)

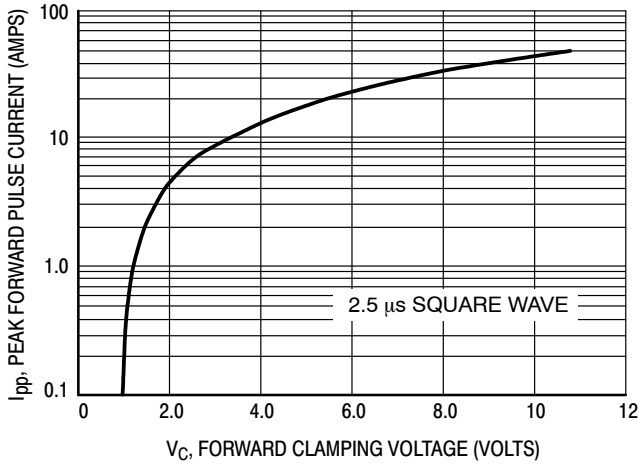

Figure 8. Clamping Voltage versus Peak Pulse Current (Forward Direction)

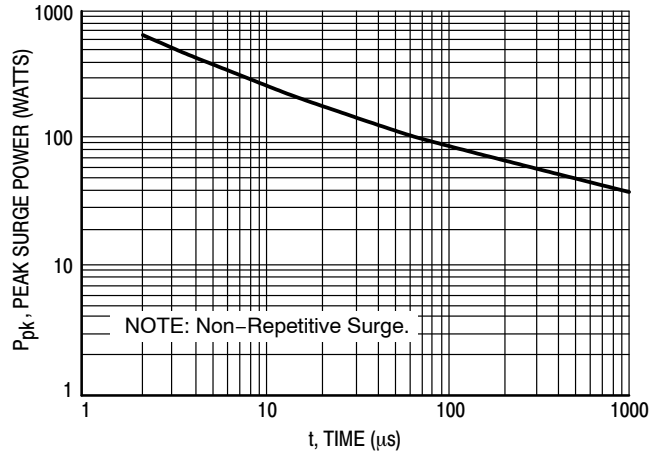

Figure 9. Pulse Width

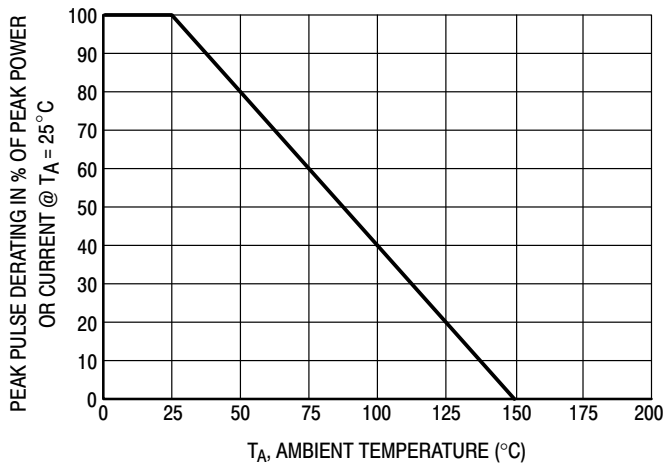

Figure 10. Pulse Derating Curve

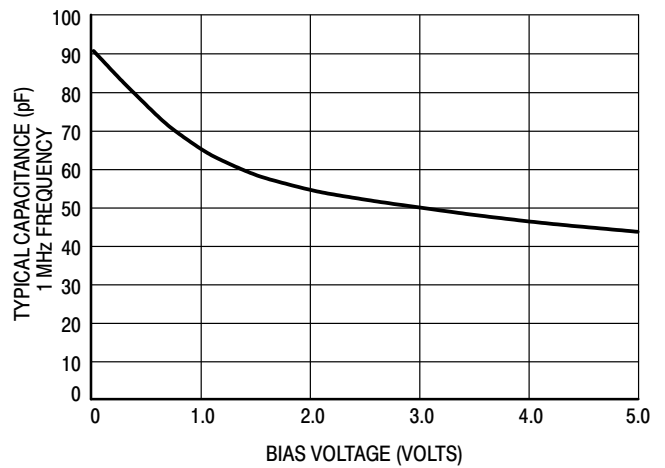

Figure 11. Capacitance

# MECHANICAL CASE OUTLINE PACKAGE DIMENSIONS



SCALE 2:1

## SC-88A (SC-70-5/SOT-353) CASE 419A-02 ISSUE M

DATE 11 APR 2023

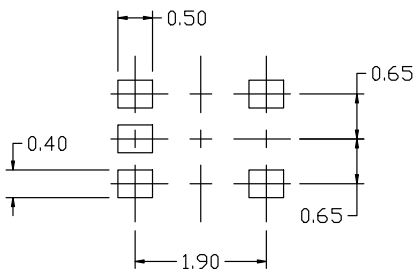
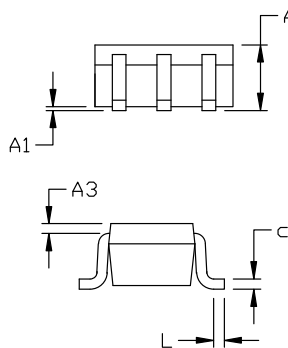
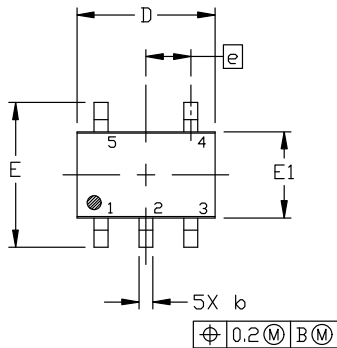

### RECOMMENDED MOUNTING FOOTPRINT

\* For additional information on our Pb-Free strategy and soldering details, please download the ON Semiconductor Soldering and Mounting Techniques Reference Manual, SOLDERM/D.

### NOTES:

1. DIMENSIONING AND TOLERANCING PER ANSI Y14.5M, 1982.
2. CONTROLLING DIMENSION: MILLIMETERS
3. 419A-01 OBSOLETE. NEW STANDARD 419A-02
4. DIMENSIONS D AND E1 DO NOT INCLUDE MOLD FLASH, PROTRUSIONS, OR GATE BURRS. MOLD FLASH, PROTRUSIONS, OR GATE BURRS SHALL NOT EXCEED 0.1016MM PER SIDE.

DIM	MILLIMETERS		
	MIN.	NOM.	MAX.
A	0.80	0.95	1.10
A1	---	---	0.10
A3	0.20 REF		
b	0.10	0.20	0.30
c	0.10	---	0.25
D	1.80	2.00	2.20
E	2.00	2.10	2.20
E1	1.15	1.25	1.35
e	0.65 BSC		
L	0.10	0.15	0.30

### GENERIC MARKING DIAGRAM\*

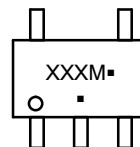

\*This information is generic. Please refer to device data sheet for actual part marking. Pb-Free indicator, "G" or microdot "▪", may or may not be present. Some products may not follow the Generic Marking.

XXX = Specific Device Code

M = Date Code

▪ = Pb-Free Package

(Note: Microdot may be in either location)

#### STYLE 1:

- PIN 1. BASE
- EMITTER
- BASE
- COLLECTOR
- COLLECTOR

#### STYLE 2:

- PIN 1. ANODE
- EMITTER
- BASE
- COLLECTOR
- CATHODE

#### STYLE 3:

- PIN 1. ANODE 1
- N/C
- ANODE 2
- CATHODE 2
- CATHODE 1

#### STYLE 4:

- PIN 1. SOURCE 1
- DRAIN 1/2
- SOURCE 1
- GATE 1
- GATE 2

#### STYLE 5:

- PIN 1. CATHODE
- COMMON ANODE
- CATHODE 2
- CATHODE 3
- CATHODE 4

#### STYLE 6:

- PIN 1. EMITTER 2
- BASE 2
- EMITTER 1
- COLLECTOR
- COLLECTOR 2/BASE 1

#### STYLE 7:

- PIN 1. BASE
- EMITTER
- BASE
- COLLECTOR
- COLLECTOR

#### STYLE 8:

- PIN 1. CATHODE
- COLLECTOR
- N/C
- BASE
- EMITTER

#### STYLE 9:

- PIN 1. ANODE
- CATHODE
- ANODE
- ANODE
- ANODE

Note: Please refer to datasheet for style callout. If style type is not called out in the datasheet refer to the device datasheet pinout or pin assignment.

<b>DOCUMENT NUMBER:</b>	<b>98ASB42984B</b>	Electronic versions are uncontrolled except when accessed directly from the Document Repository. Printed versions are uncontrolled except when stamped "CONTROLLED COPY" in red.
<b>DESCRIPTION:</b>	<b>SC-88A (SC-70-5/SOT-353)</b>	<b>PAGE 1 OF 1</b>

onsemi and ONSEMI are trademarks of Semiconductor Components Industries, LLC dba onsemi or its subsidiaries in the United States and/or other countries. onsemi reserves the right to make changes without further notice to any products herein. onsemi makes no warranty, representation or guarantee regarding the suitability of its products for any particular purpose, nor does onsemi assume any liability arising out of the application or use of any product or circuit, and specifically disclaims any and all liability, including without limitation special, consequential or incidental damages. onsemi does not convey any license under its patent rights nor the rights of others.

**onsemi**, **Onsemi**, and other names, marks, and brands are registered and/or common law trademarks of Semiconductor Components Industries, LLC dba "**onsemi**" or its affiliates and/or subsidiaries in the United States and/or other countries. **onsemi** owns the rights to a number of patents, trademarks, copyrights, trade secrets, and other intellectual property. A listing of **onsemi**'s product/patent coverage may be accessed at [www.onsemi.com/site/pdf/Patent-Marking.pdf](http://www.onsemi.com/site/pdf/Patent-Marking.pdf). **onsemi** reserves the right to make changes at any time to any products or information herein, without notice. The information herein is provided "as-is" and **onsemi** makes no warranty, representation or guarantee regarding the accuracy of the information, product features, availability, functionality, or suitability of its products for any particular purpose, nor does **onsemi** assume any liability arising out of the application or use of any product or circuit, and specifically disclaims any and all liability, including without limitation special, consequential or incidental damages. Buyer is responsible for its products and applications using **onsemi** products, including compliance with all laws, regulations and safety requirements or standards, regardless of any support or applications information provided by **onsemi**. "Typical" parameters which may be provided in **onsemi** data sheets and/or specifications can and do vary in different applications and actual performance may vary over time. All operating parameters, including "Typicals" must be validated for each customer application by customer's technical experts. **onsemi** does not convey any license under any of its intellectual property rights nor the rights of others. **onsemi** products are not designed, intended, or authorized for use as a critical component in life support systems or any FDA Class 3 medical devices or medical devices with a same or similar classification in a foreign jurisdiction or any devices intended for implantation in the human body. Should Buyer purchase or use **onsemi** products for any such unintended or unauthorized application, Buyer shall indemnify and hold **onsemi** and its officers, employees, subsidiaries, affiliates, and distributors harmless against all claims, costs, damages, and expenses, and reasonable attorney fees arising out of, directly or indirectly, any claim of personal injury or death associated with such unintended or unauthorized use, even if such claim alleges that **onsemi** was negligent regarding the design or manufacture of the part. **onsemi** is an Equal Opportunity/Affirmative Action Employer. This literature is subject to all applicable copyright laws and is not for resale in any manner.

---

## ADDITIONAL INFORMATION

### TECHNICAL PUBLICATIONS:

Technical Library: [www.onsemi.com/design/resources/technical-documentation](http://www.onsemi.com/design/resources/technical-documentation)  
onsemi Website: [www.onsemi.com](http://www.onsemi.com)

### ONLINE SUPPORT: [www.onsemi.com/support](http://www.onsemi.com/support)

For additional information, please contact your local Sales Representative at [www.onsemi.com/support/sales](http://www.onsemi.com/support/sales)



## Looking for pricing, stock, or lifecycle information?

Click below to explore more details on WIN SOURCE:

- ⊖ [View MSQA6V1W5T2G on WIN SOURCE](#)
- ⊖ [ON Semiconductor Information](#)

## Optimize Your Supply Chain with WIN SOURCE Solutions

- ✓ Global Sourcing Solution
- ✓ Obsolete Management
- ✓ Cost Control Management
- ✓ Shortage Management
- ✓ Alternative Solution
- ✓ Excess Inventory Management