



**THE DATASHEET OF  
MMDT3946-7-F**



**40V COMPLEMENTARY NPN-PNP SMALL SIGNAL TRANSISTOR IN SOT363**

### Features

- Complementary Pair One 3904-Type NPN  
One 3906-Type PNP
- Ultra-Small Surface Mount Package
- Epitaxial Planar Die Construction
- Ideal for Low Power Amplification and Switching
- **Totally Lead-Free & Fully RoHS Compliant (Notes 1 & 2)**
- **Halogen and Antimony Free. "Green" Device (Note 3)**
- **Qualified to AEC-Q101 Standards for High Reliability**
- **An Automotive-Compliant Part is Available Under Separate Datasheet ([MMDT3946Q](#))**

### Mechanical Data

- Case: SOT363
- Case Material: Molded Plastic, "Green" Molding Compound.  
UL Flammability Classification Rating 94V-0
- Moisture Sensitivity: Level 1 per J-STD-020
- Terminals: Finish — Matte Tin Finish. Solderable per  
MIL-STD-202, Method 208
- Weight: 0.006 grams (Approximate)



Top View

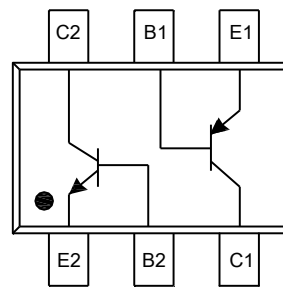

E1, B1, C1 = PNP 3906  
E2, B2, C2 = NPN 3904

Device Schematic and Pinout  
Top View

### Ordering Information (Note 4)

Part Number	Compliance	Marking	Reel Size (inches)	Tape Width (mm)	Quantity Per Reel
MMDT3946-7-F	AEC-Q101	K46	7	8	3,000
MMDT3946-7R-F	AEC-Q101	K46	7	8	3,000

- Notes:
1. No purposely added lead. Fully EU Directive 2002/95/EC (RoHS), 2011/65/EU (RoHS 2) & 2015/863/EU (RoHS 3) compliant.
  2. See <https://www.diodes.com/quality/lead-free/> for more information about Diodes Incorporated's definitions of Halogen- and Antimony-free, "Green" and Lead-free.
  3. Halogen- and Antimony-free "Green" products are defined as those which contain <900ppm bromine, <900ppm chlorine (<1500ppm total Br + Cl) and <1000ppm antimony compounds.
  4. For packaging details, go to our website at <https://www.diodes.com/design/support/packaging/diodes-packaging/>.

### Marking Information

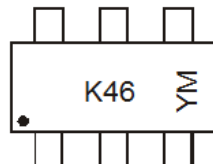

K46 = Product Type Marking Code  
YM = Date Code Marking  
Y = Year (ex: F = 2018)  
M = Month (ex: 9 = September)

#### Date Code Key

Year	2018	2019	2020	2021	2022	2023	2024	2025				
Code	F	G	H	I	J	K	L	M				
Month	Jan	Feb	Mar	Apr	May	Jun	Jul	Aug	Sep	Oct	Nov	Dec
Code	1	2	3	4	5	6	7	8	9	O	N	D

**Absolute Maximum Ratings, NPN 3904** (@ $T_A = +25^{\circ}\text{C}$ , unless otherwise specified.)

Characteristic	Symbol	Value	Unit
Collector-Base Voltage	$V_{CBO}$	60	V
Collector-Emitter Voltage	$V_{CEO}$	40	V
Emitter-Base Voltage	$V_{EBO}$	6.0	V
Collector Current	$I_C$	200	mA

**Absolute Maximum Ratings, PNP 3906** (@ $T_A = +25^{\circ}\text{C}$ , unless otherwise specified.)

Characteristic	Symbol	Value	Unit
Collector-Base Voltage	$V_{CBO}$	-40	V
Collector-Emitter Voltage	$V_{CEO}$	-40	V
Emitter-Base Voltage	$V_{EBO}$	-5.0	V
Collector Current	$I_C$	-200	mA

**Thermal Characteristics, Total Device** (@ $T_A = +25^{\circ}\text{C}$ , unless otherwise specified.)

Characteristic	Symbol	Value	Unit
Power Dissipation (Note 5)	$P_D$	200	mW
Thermal Resistance, Junction to Ambient Air (Note 5)	$R_{\theta JA}$	625	$^{\circ}\text{C}/\text{W}$
Operating and Storage Temperature Range	$T_J, T_{STG}$	-55 to +150	$^{\circ}\text{C}$

Notes: 5. For a device mounted on minimum recommended pad layout that is on a single-sided 0.6mm FR-4 PCB; device is measured under still air conditions whilst operating in a steady-state.

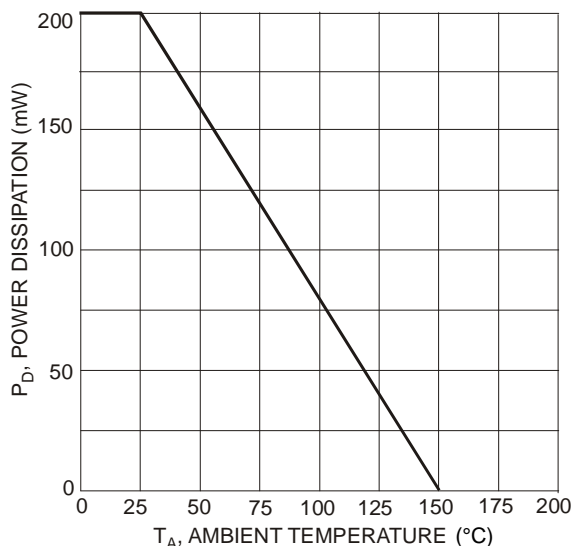

Fig. 1, Power Dissipation vs. Ambient Temperature (Total Device)

**Electrical Characteristics, NPN 3904** (@T<sub>A</sub> = +25°C, unless otherwise specified.)

Characteristic	Symbol	Min	Max	Unit	Test Condition
<b>OFF CHARACTERISTICS (Note 6)</b>					
Collector-Base Breakdown Voltage	BV <sub>CBO</sub>	60	—	V	I <sub>C</sub> = 10μA, I <sub>E</sub> = 0
Collector-Emitter Breakdown Voltage	BV <sub>CEO</sub>	40	—	V	I <sub>C</sub> = 1.0mA, I <sub>B</sub> = 0
Emitter-Base Breakdown Voltage	BV <sub>EBO</sub>	6.0	—	V	I <sub>E</sub> = 10μA, I <sub>C</sub> = 0
Collector Cutoff Current	I <sub>CEX</sub>	—	50	nA	V <sub>CE</sub> = 30V, V <sub>EB(OFF)</sub> = 3.0V
Base Cutoff Current	I <sub>BL</sub>	—	50	nA	V <sub>CE</sub> = 30V, V <sub>EB(OFF)</sub> = 3.0V
<b>ON CHARACTERISTICS (Note 6)</b>					
Static Forward Current Transfer Ratio	h <sub>FE</sub>	40 70 100 60 30	— — 300 — —	—	I <sub>C</sub> = 100μA, V <sub>CE</sub> = 1.0V I <sub>C</sub> = 1.0mA, V <sub>CE</sub> = 1.0V I <sub>C</sub> = 10mA, V <sub>CE</sub> = 1.0V I <sub>C</sub> = 50mA, V <sub>CE</sub> = 1.0V I <sub>C</sub> = 100mA, V <sub>CE</sub> = 1.0V
Collector-Emitter Saturation Voltage	V <sub>CE(SAT)</sub>	—	0.20 0.30	V	I <sub>C</sub> = 10mA, I <sub>B</sub> = 1.0mA I <sub>C</sub> = 50mA, I <sub>B</sub> = 5.0mA
Base-Emitter Saturation Voltage	V <sub>BE(SAT)</sub>	0.65 —	0.85 0.95	V	I <sub>C</sub> = 10mA, I <sub>B</sub> = 1.0mA I <sub>C</sub> = 50mA, I <sub>B</sub> = 5.0mA
<b>SMALL SIGNAL CHARACTERISTICS</b>					
Output Capacitance	C <sub>obo</sub>	—	4.0	pF	V <sub>CB</sub> = 5.0V, f = 1.0MHz, I <sub>E</sub> = 0
Input Capacitance	C <sub>ibo</sub>	—	8.0	pF	V <sub>EB</sub> = 0.5V, f = 1.0MHz, I <sub>C</sub> = 0
Input Impedance	h <sub>ie</sub>	1.0	10	kΩ	V <sub>CE</sub> = 10V, I <sub>C</sub> = 1.0mA, f = 1.0kHz
Voltage Feedback Ratio	h <sub>re</sub>	0.5	8.0	x 10 <sup>-4</sup>	
Small Signal Current Gain	h <sub>fe</sub>	100	400	—	
Output Admittance	h <sub>oe</sub>	1.0	40	μS	
Current Gain-Bandwidth Product	f <sub>T</sub>	300	—	MHz	V <sub>CE</sub> = 20V, I <sub>C</sub> = 20mA, f = 100MHz
Noise Figure	NF	—	5.0	dB	V <sub>CE</sub> = 5.0V, I <sub>C</sub> = 100μA, R <sub>S</sub> = 1.0kΩ, f = 1.0kHz
<b>SWITCHING CHARACTERISTICS</b>					
Delay Time	t <sub>d</sub>	—	35	ns	V <sub>CC</sub> = 3.0V, I <sub>C</sub> = 10mA, V <sub>BE(off)</sub> = 0.5V, I <sub>B1</sub> = 1.0mA
Rise Time	t <sub>r</sub>	—	35	ns	
Storage Time	t <sub>s</sub>	—	200	ns	V <sub>CC</sub> = 3.0V, I <sub>C</sub> = 10mA, I <sub>B1</sub> = -I <sub>B2</sub> = 1.0mA
Fall Time	t <sub>f</sub>	—	50	ns	

Notes: 6. Measured under pulsed conditions. Pulse width ≤ 300μs. Duty cycle ≤ 2%.

**Typical Electrical Characteristics, NPN 3904** (@ $T_A = +25^\circ\text{C}$ , unless otherwise specified.)

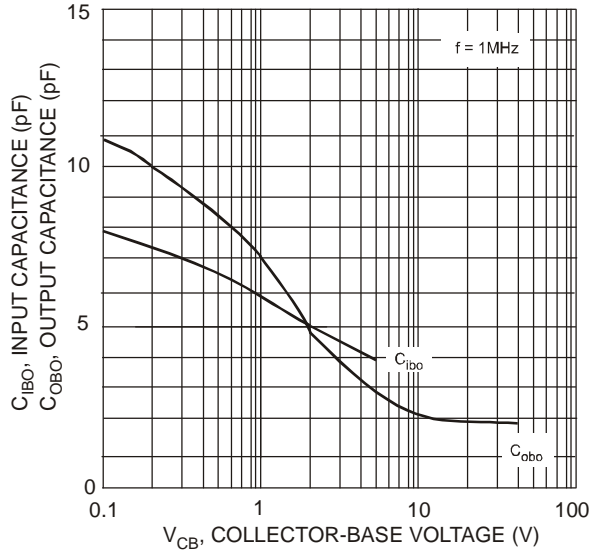

Fig. 2, Input and Output Capacitance vs. Collector-Base Voltage (NPN-3904)

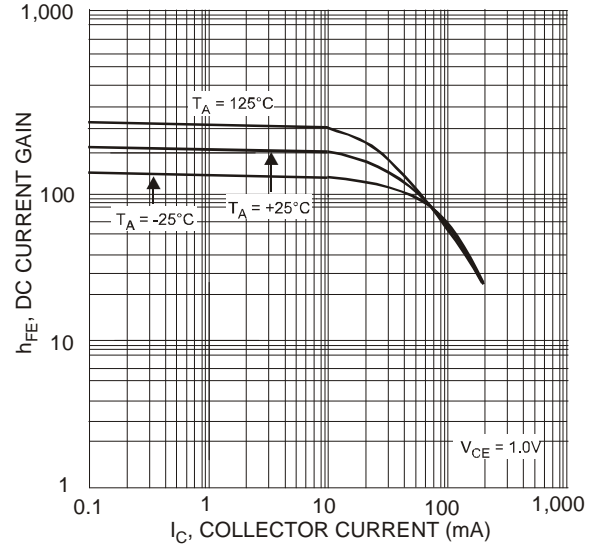

Fig. 3, Typical DC Current Gain vs. Collector Current (NPN-3904)

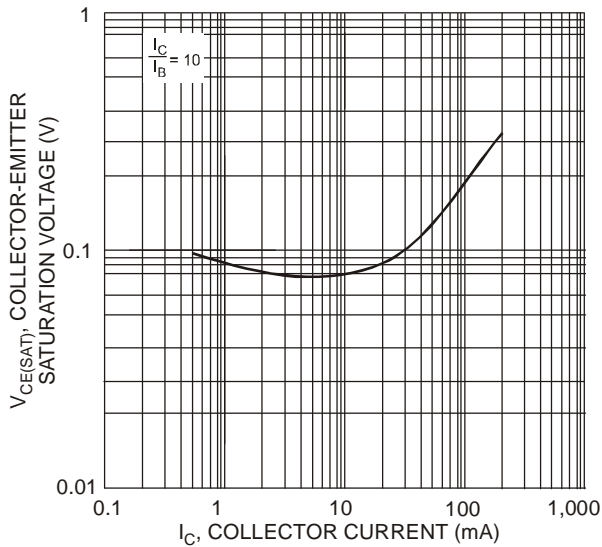

Fig. 4, Typical Collector-Emitter Saturation Voltage vs. Collector Current (NPN-3904)

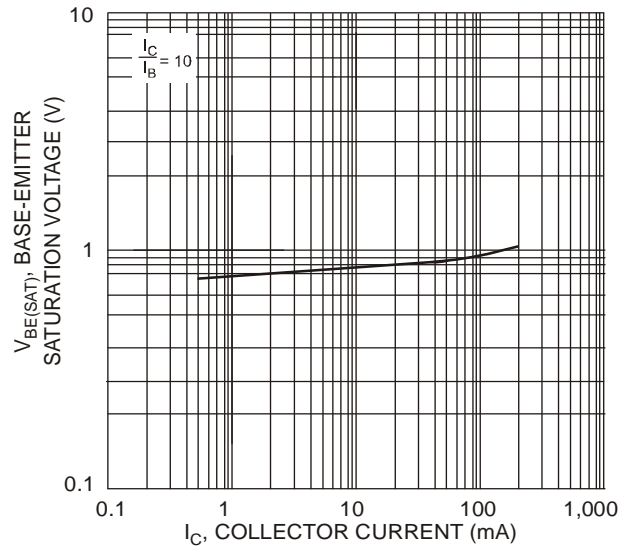

Fig. 5, Typical Base-Emitter Saturation Voltage vs. Collector Current (NPN-3904)

**Electrical Characteristics, PNP 3906** (@T<sub>A</sub> = +25°C, unless otherwise specified.)

Characteristic	Symbol	Min	Max	Unit	Test Condition
<b>OFF CHARACTERISTICS (Note 6)</b>					
Collector-Base Breakdown Voltage	BV <sub>CBO</sub>	-40	—	V	I <sub>C</sub> = -10μA, I <sub>E</sub> = 0
Collector-Emitter Breakdown Voltage	BV <sub>CEO</sub>	-40	—	V	I <sub>C</sub> = -1.0mA, I <sub>B</sub> = 0
Emitter-Base Breakdown Voltage	BV <sub>EBO</sub>	-5.0	—	V	I <sub>E</sub> = -10μA, I <sub>C</sub> = 0
Collector Cutoff Current	I <sub>CEX</sub>	—	-50	nA	V <sub>CE</sub> = -30V, V <sub>EB(OFF)</sub> = -3.0V
Base Cutoff Current	I <sub>BL</sub>	—	-50	nA	V <sub>CE</sub> = -30V, V <sub>EB(OFF)</sub> = -3.0V
<b>ON CHARACTERISTICS (Note 6)</b>					
Static Forward Current Transfer Ratio	h <sub>FE</sub>	60 80 100 60 30	— — 300 — —	—	I <sub>C</sub> = -100μA, V <sub>CE</sub> = -1.0V I <sub>C</sub> = -1.0mA, V <sub>CE</sub> = -1.0V I <sub>C</sub> = -10mA, V <sub>CE</sub> = -1.0V I <sub>C</sub> = -50mA, V <sub>CE</sub> = -1.0V I <sub>C</sub> = -100mA, V <sub>CE</sub> = -1.0V
Collector-Emitter Saturation Voltage	V <sub>CE(SAT)</sub>	—	-0.25 -0.40	V	I <sub>C</sub> = -10mA, I <sub>B</sub> = -1.0mA I <sub>C</sub> = -50mA, I <sub>B</sub> = -5.0mA
Base-Emitter Saturation Voltage	V <sub>BE(SAT)</sub>	-0.65 —	-0.85 -0.95	V	I <sub>C</sub> = -10mA, I <sub>B</sub> = -1.0mA I <sub>C</sub> = -50mA, I <sub>B</sub> = -5.0mA
<b>SMALL SIGNAL CHARACTERISTICS</b>					
Output Capacitance	C <sub>obo</sub>	—	4.5	pF	V <sub>CB</sub> = -5.0V, f = 1.0MHz, I <sub>E</sub> = 0
Input Capacitance	C <sub>ibo</sub>	—	10	pF	V <sub>EB</sub> = -0.5V, f = 1.0MHz, I <sub>C</sub> = 0
Input Impedance	h <sub>ie</sub>	2.0	12	kΩ	V <sub>CE</sub> = -10V, I <sub>C</sub> = -1.0mA, f = 1.0kHz
Voltage Feedback Ratio	h <sub>re</sub>	0.1	10	x 10 <sup>-4</sup>	
Small Signal Current Gain	h <sub>fe</sub>	100	400	—	
Output Admittance	h <sub>oe</sub>	3.0	60	μS	
Current Gain-Bandwidth Product	f <sub>T</sub>	250	—	MHz	V <sub>CE</sub> = -20V, I <sub>C</sub> = -10mA, f = 100MHz
Noise Figure	NF	—	4.0	dB	V <sub>CE</sub> = -5.0V, I <sub>C</sub> = -100μA, R <sub>S</sub> = 1.0kΩ, f = 1.0kHz
<b>SWITCHING CHARACTERISTICS</b>					
Delay Time	t <sub>d</sub>	—	35	ns	V <sub>CC</sub> = -3.0V, I <sub>C</sub> = -10mA,
Rise Time	t <sub>r</sub>	—	35	ns	V <sub>BE(off)</sub> = -0.5V, I <sub>B1</sub> = -1.0mA
Storage Time	t <sub>s</sub>	—	225	ns	V <sub>CC</sub> = -3.0V, I <sub>C</sub> = -10mA,
Fall Time	t <sub>f</sub>	—	75	ns	I <sub>B1</sub> = -I <sub>B2</sub> = -1.0mA

Notes: 6. Measured under pulsed conditions. Pulse width ≤ 300μs. Duty cycle ≤ 2%.

**Typical Electrical Characteristics, PNP 3906** (@ $T_A = +25^\circ\text{C}$ , unless otherwise specified.)

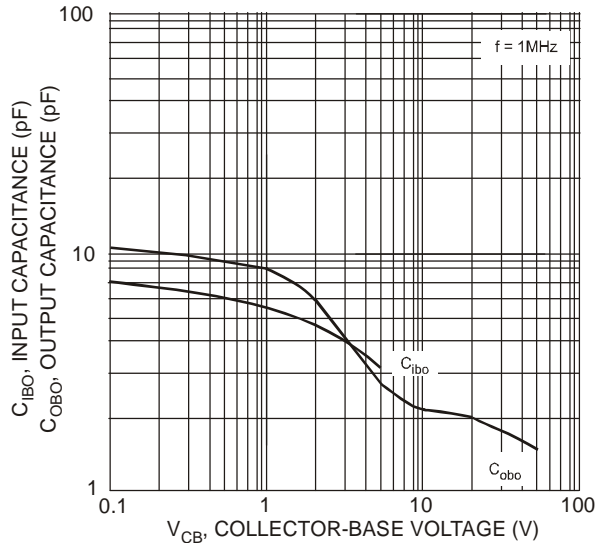

Fig. 6, Input and Output Capacitance vs. Collector-Base Voltage (PNP-3906)

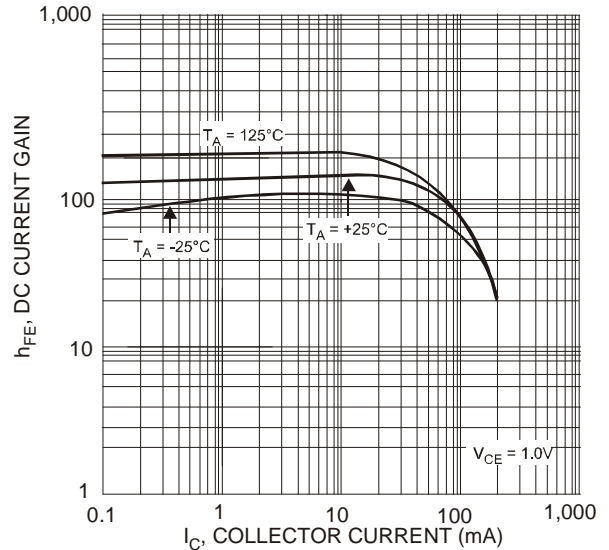

Fig. 7, Typical DC Current Gain vs. Collector Current (PNP-3906)

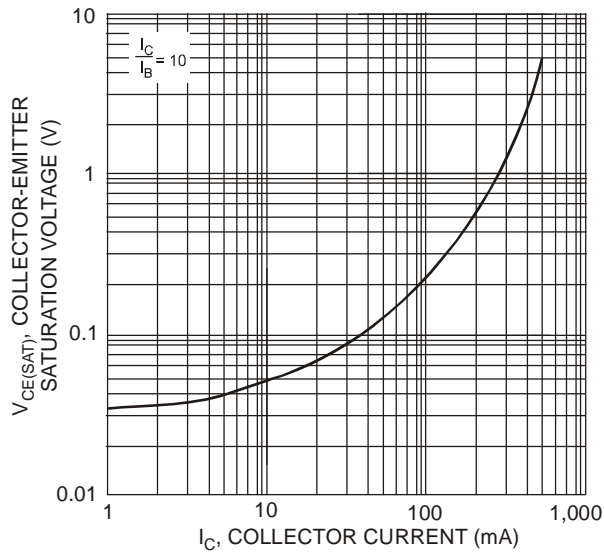

Fig. 8, Typical Collector-Emitter Saturation Voltage vs. Collector Current (PNP-3906)

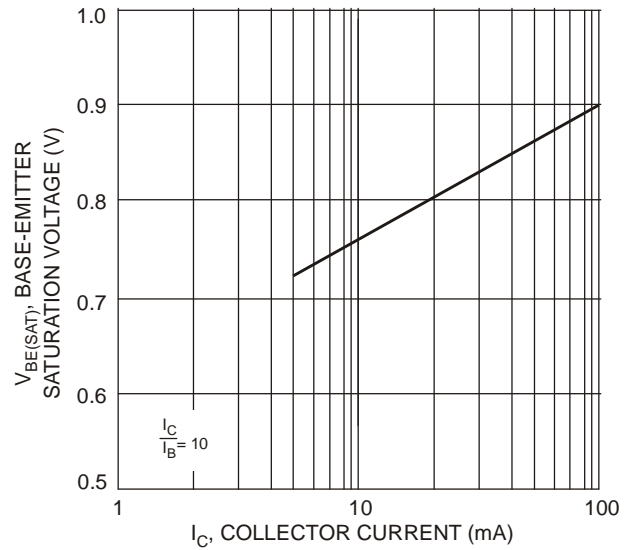
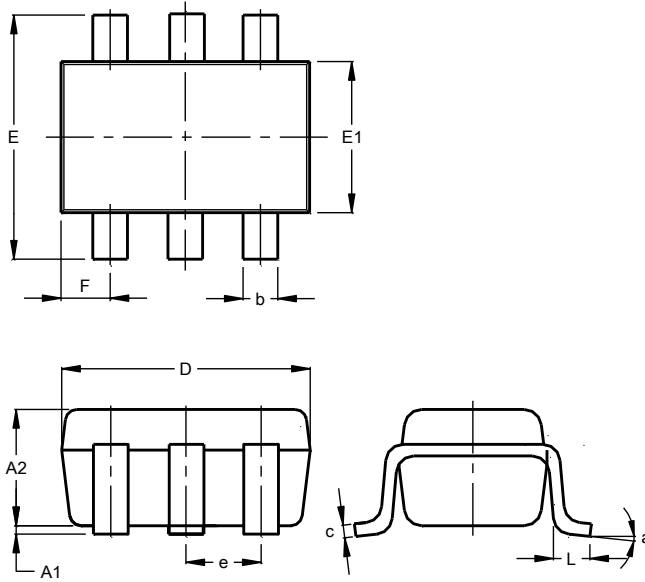

Fig. 9, Typical Base-Emitter Saturation Voltage vs. Collector Current (PNP-3906)

**Package Outline Dimensions**

Please see <http://www.diodes.com/package-outlines.html> for the latest version.

**SOT363**



SOT363			
Dim	Min	Max	Typ
A1	0.00	0.10	0.05
A2	0.90	1.00	0.95
b	0.10	0.30	0.25
c	0.10	0.22	0.11
D	1.80	2.20	2.15
E	2.00	2.20	2.10
E1	1.15	1.35	1.30
e	0.650 BSC		
F	0.40	0.45	0.425
L	0.25	0.40	0.30
a	0°	8°	--
All Dimensions in mm			

**Suggested Pad Layout**

Please see <http://www.diodes.com/package-outlines.html> for the latest version.

**SOT363**

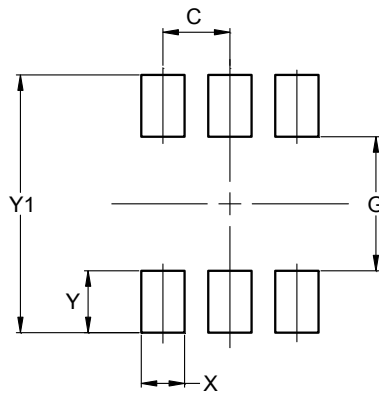

Dimensions	Value (in mm)
C	0.650
G	1.300
X	0.420
Y	0.600
Y1	2.500

**IMPORTANT NOTICE**

DIODES INCORPORATED MAKES NO WARRANTY OF ANY KIND, EXPRESS OR IMPLIED, WITH REGARDS TO THIS DOCUMENT, INCLUDING, BUT NOT LIMITED TO, THE IMPLIED WARRANTIES OF MERCHANTABILITY AND FITNESS FOR A PARTICULAR PURPOSE (AND THEIR EQUIVALENTS UNDER THE LAWS OF ANY JURISDICTION).

Diodes Incorporated and its subsidiaries reserve the right to make modifications, enhancements, improvements, corrections or other changes without further notice to this document and any product described herein. Diodes Incorporated does not assume any liability arising out of the application or use of this document or any product described herein; neither does Diodes Incorporated convey any license under its patent or trademark rights, nor the rights of others. Any Customer or user of this document or products described herein in such applications shall assume all risks of such use and will agree to hold Diodes Incorporated and all the companies whose products are represented on Diodes Incorporated website, harmless against all damages.

Diodes Incorporated does not warrant or accept any liability whatsoever in respect of any products purchased through unauthorized sales channel. Should Customers purchase or use Diodes Incorporated products for any unintended or unauthorized application, Customers shall indemnify and hold Diodes Incorporated and its representatives harmless against all claims, damages, expenses, and attorney fees arising out of, directly or indirectly, any claim of personal injury or death associated with such unintended or unauthorized application.

Products described herein may be covered by one or more United States, international or foreign patents pending. Product names and markings noted herein may also be covered by one or more United States, international or foreign trademarks.

This document is written in English but may be translated into multiple languages for reference. Only the English version of this document is the final and determinative format released by Diodes Incorporated.

**LIFE SUPPORT**

Diodes Incorporated products are specifically not authorized for use as critical components in life support devices or systems without the express written approval of the Chief Executive Officer of Diodes Incorporated. As used herein:

A. Life support devices or systems are devices or systems which:

1. are intended to implant into the body, or
2. support or sustain life and whose failure to perform when properly used in accordance with instructions for use provided in the labeling can be reasonably expected to result in significant injury to the user.

B. A critical component is any component in a life support device or system whose failure to perform can be reasonably expected to cause the failure of the life support device or to affect its safety or effectiveness.



Customers represent that they have all necessary expertise in the safety and regulatory ramifications of their life support devices or systems, and acknowledge and agree that they are solely responsible for all legal, regulatory and safety-related requirements concerning their products and any use of Diodes Incorporated products in such safety-critical, life support devices or systems, notwithstanding any devices- or systems-related information or support that may be provided by Diodes Incorporated. Further, Customers must fully indemnify Diodes Incorporated and its representatives against any damages arising out of the use of Diodes Incorporated products in such safety-critical, life support devices or systems.

Copyright © 2018, Diodes Incorporated

[www.diodes.com](http://www.diodes.com)

## Looking for pricing, stock, or lifecycle information?

Click below to explore more details on WIN SOURCE:

-  [View MMDT3946-7-F on WIN SOURCE](#)
-  [Diodes Incorporated Information](#)

## Optimize Your Supply Chain with WIN SOURCE Solutions

-  Global Sourcing Solution
-  Obsolete Management
-  Cost Control Management
-  Shortage Management
-  Alternative Solution
-  Excess Inventory Management