



**THE DATASHEET OF
MBRS130LT3G**



Schottky Power Rectifier

Surface Mount Power Package

MBRS130LT3G, SBRS8130LT3G, SBRS8130LN

This device employs the Schottky Barrier principle in a large area metal-to-silicon power diode. State-of-the-art geometry features epitaxial construction with oxide passivation and metal overlay contact. Ideally suited for low voltage, high frequency rectification, or as free wheeling and polarity protection diodes, in surface mount applications where compact size and weight are critical to the system.

Features

- Very Low Forward Voltage Drop (0.395 Volts Max @ 1.0 A, $T_J = 25^\circ\text{C}$)
- Small Compact Surface Mountable Package with J-Bend Leads
- Highly Stable Oxide Passivated Junction
- Guard-Ring for Stress Protection
- ESD Ratings:
 - ◆ Human Body Model = 3B (> 16000 V)
 - ◆ Machine Model = C (> 400 V)
- SBRS8 Prefix for Automotive and Other Applications Requiring Unique Site and Control Change Requirements; AEC-Q101 Qualified and PPAP Capable*
- These are Pb-Free Devices

Mechanical Characteristics

- Case: Epoxy, Molded
- Weight: 100 mg (approximately)
- Finish: All External Surfaces Corrosion Resistant and Terminal Leads are Readily Solderable
- Lead and Mounting Surface Temperature for Soldering Purposes: 260°C Max. for 10 Seconds
- Cathode Polarity Band



ON Semiconductor®

www.onsemi.com

SCHOTTKY BARRIER RECTIFIER 1.0 AMPERE 30 VOLTS



**SMB
CASE 403A**

MARKING DIAGRAM

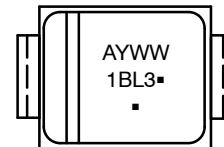

- 1BL3 = Specific Device Code
- A = Assembly Location**
- Y = Year
- WW = Work Week
- = Pb-Free Package

(Note: Microdot may be in either location)

**The Assembly Location code (A) is front side optional. In cases where the Assembly Location is stamped in the package bottom (molding ejector pin), the front side assembly code may be blank.

ORDERING INFORMATION

Device	Package	Shipping†
MBRS130LT3G	SMB (Pb-Free)	2,500 / Tape & Reel
SBRS8130LT3G*	SMB (Pb-Free)	2,500 / Tape & Reel
SBRS8130LT3G-VF01*	SMB (Pb-Free)	2,500 / Tape & Reel
SBRS8130LNT3G*	SMB (Pb-Free)	2,500 / Tape & Reel

†For information on tape and reel specifications, including part orientation and tape sizes, please refer to our Tape and Reel Packaging Specifications Brochure, BRD8011/D.

MBRS130LT3G, SBRS8130LT3G, SBRS8130LN

MAXIMUM RATINGS

Rating	Symbol	Value	Unit
Peak Repetitive Reverse Voltage Working Peak Reverse Voltage DC Blocking Voltage	V_{RRM} V_{RWM} V_R	30	V
Average Rectified Forward Current $T_L = 120^\circ\text{C}$ $T_L = 110^\circ\text{C}$	$I_{F(AV)}$	1.0 2.0	A
Non-Repetitive Peak Surge Current (Surge Applied at Rated Load Conditions Halfwave, Single Phase, 60 Hz)	I_{FSM}	40	A
Operating Junction Temperature	T_J	-65 to +125	$^\circ\text{C}$

Stresses exceeding those listed in the Maximum Ratings table may damage the device. If any of these limits are exceeded, device functionality should not be assumed, damage may occur and reliability may be affected.

THERMAL CHARACTERISTICS

Characteristic	Symbol	Value	Unit
Thermal Resistance, Junction-to-Lead	Ψ_{JL}	12	$^\circ\text{C/W}$
Thermal Resistance, Junction-to-Ambient ($T_A = 25^\circ\text{C}$, Min Pad, 1 oz copper) Junction-to-Ambient ($T_A = 25^\circ\text{C}$, 1" Pad, 1 oz copper)	$R_{\theta JA}$	228.8 71.3	$^\circ\text{C/W}$

ELECTRICAL CHARACTERISTICS

Characteristic	Symbol	Value	Unit
Maximum Instantaneous Forward Voltage (Note 1) ($I_F = 1.0\text{ A}$, $T_J = 25^\circ\text{C}$) ($I_F = 2.0\text{ A}$, $T_J = 25^\circ\text{C}$)	V_F	0.395 0.445	V
Maximum Instantaneous Reverse Current (Note 1) (Rated dc Voltage, $T_J = 25^\circ\text{C}$) (Rated dc Voltage, $T_J = 100^\circ\text{C}$)	I_R	1.0 10	mA

Product parametric performance is indicated in the Electrical Characteristics for the listed test conditions, unless otherwise noted. Product performance may not be indicated by the Electrical Characteristics if operated under different conditions.

1. Pulse Test: Pulse Width = 300 μs , Duty Cycle $\leq 2\%$.

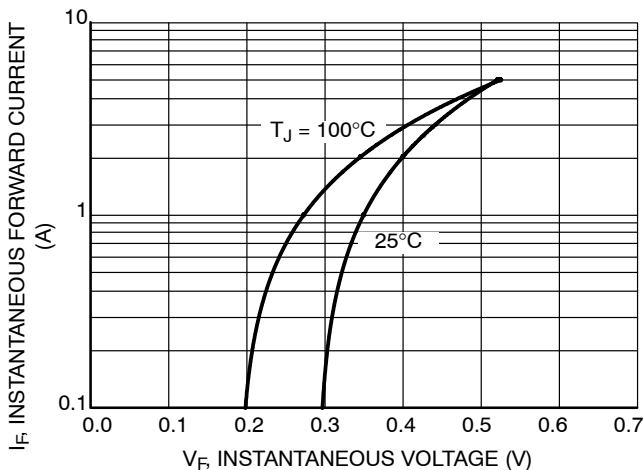

Figure 1. Typical Forward Voltage

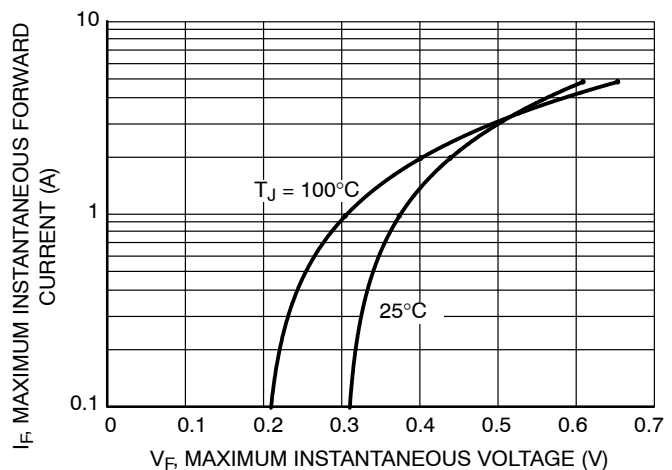

Figure 2. Maximum Forward Voltage

MBRS130LT3G, SBRS8130LT3G, SBRS8130LN

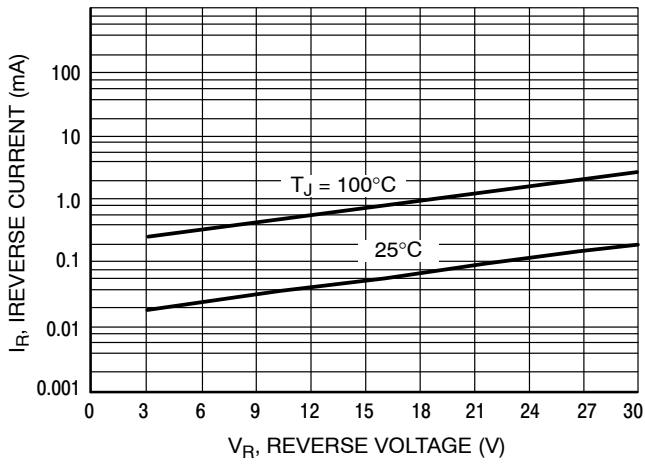

Figure 3. Typical Reverse Leakage Current

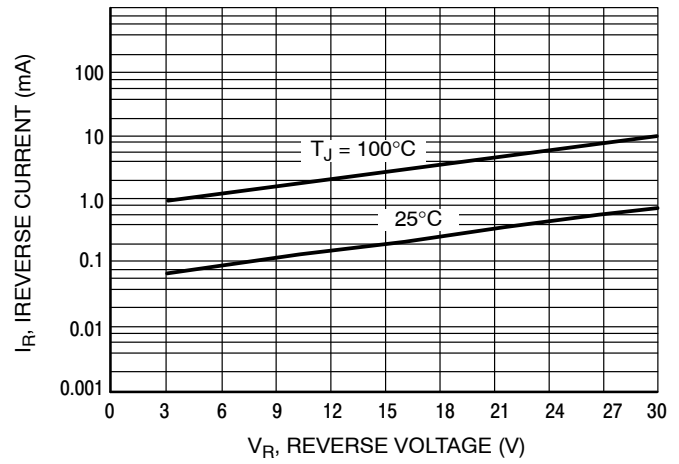

Figure 4. Typical Maximum Reverse Leakage Current

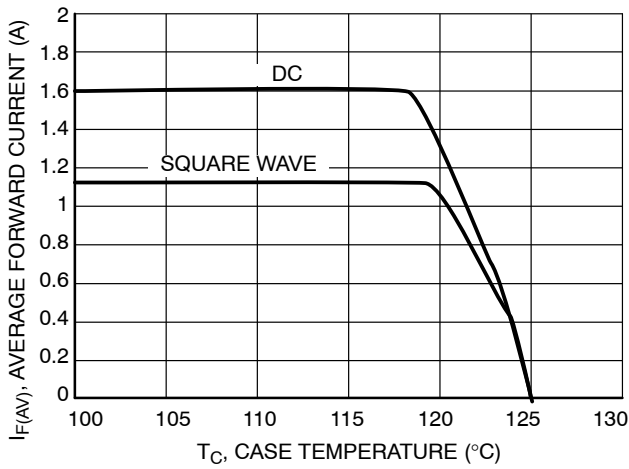

Figure 5. Current Derating (Case)

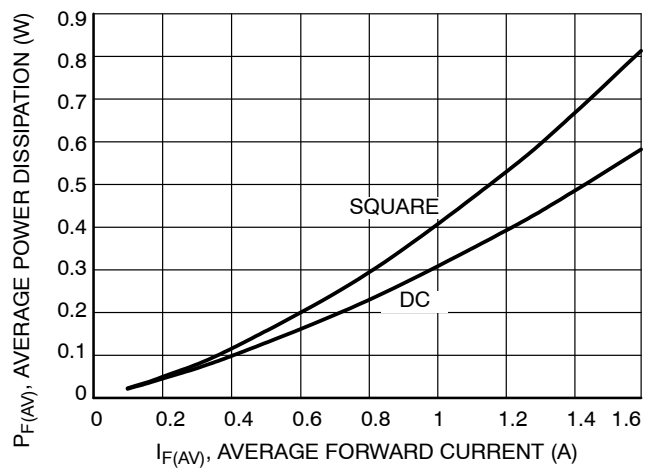

Figure 6. Typical Power Dissipation

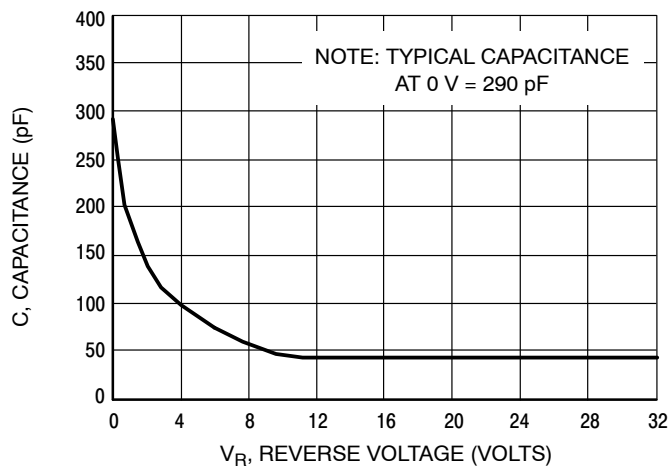

Figure 7. Typical Capacitance

MBRS130LT3G, SBRS8130LT3G, SBRS8130LN

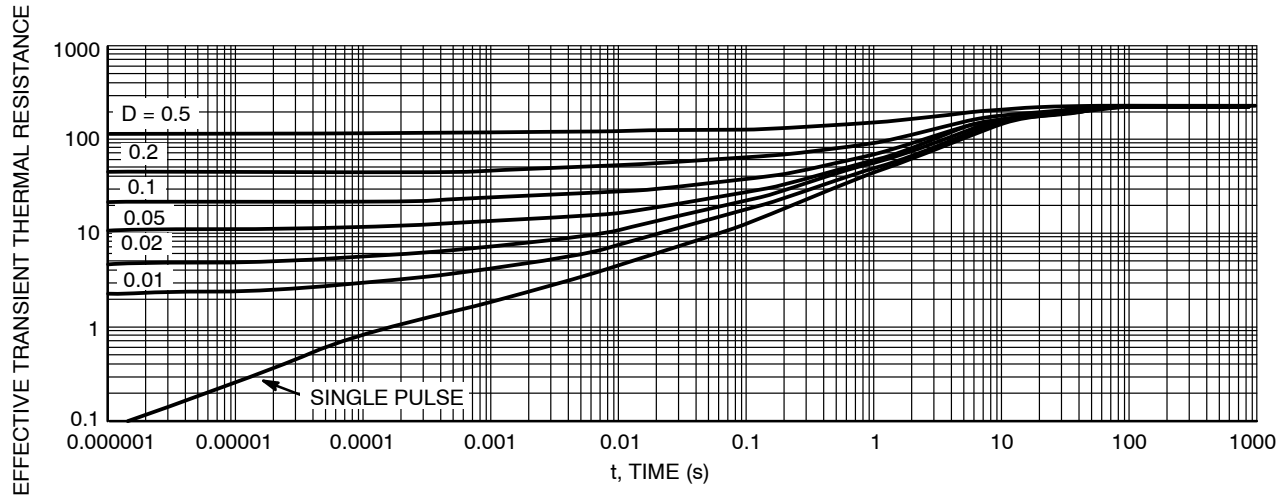

Figure 8. Thermal Response, Min Pad

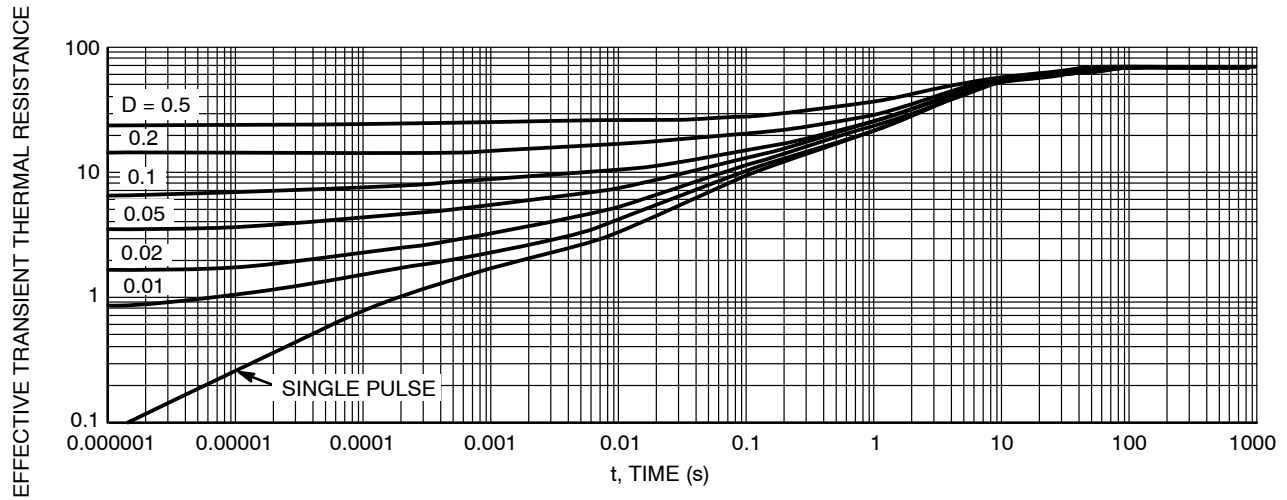

Figure 9. Thermal Response, 1 Inch Pad

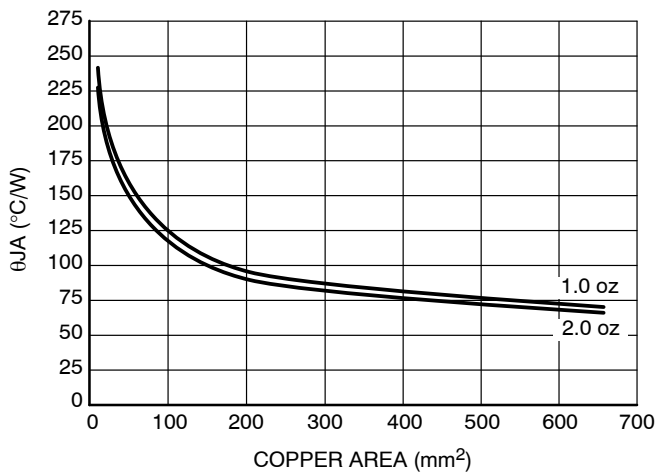

Figure 10. Thermal Resistance vs. Copper Area

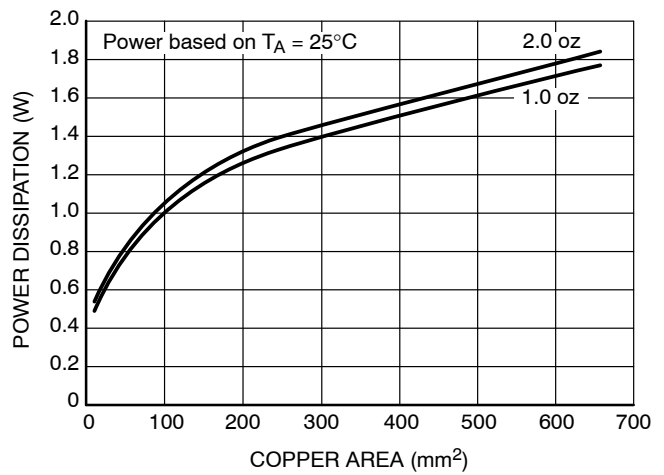

Figure 11. Power Dissipation vs. Copper Area

MECHANICAL CASE OUTLINE

PACKAGE DIMENSIONS

ON Semiconductor®



SCALE 1:1

Polarity Band



SCALE 1:1

Non-Polarity Band

SMB
CASE 403A-03
ISSUE J

DATE 19 JUL 2012

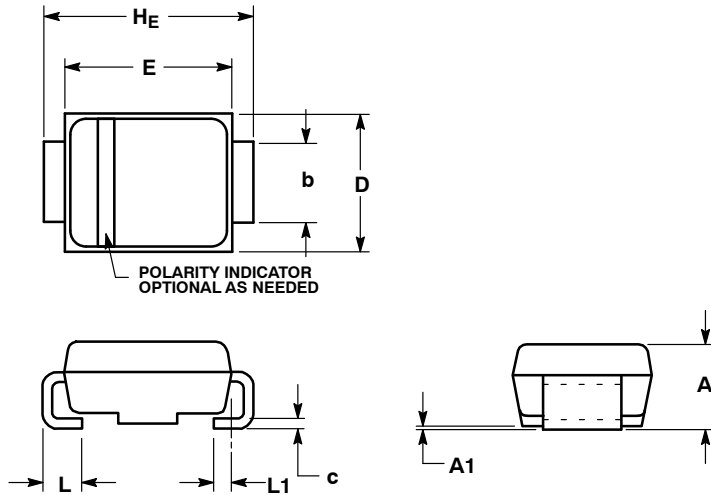

SOLDERING FOOTPRINT*

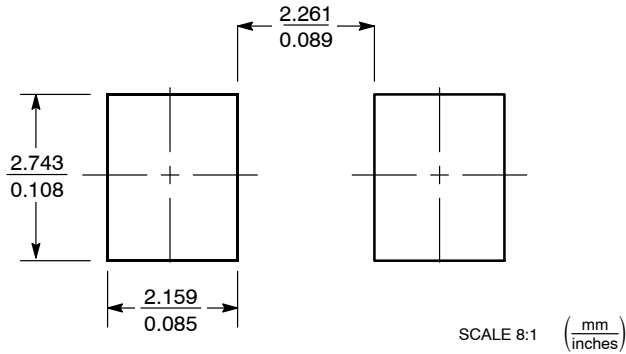

*For additional information on our Pb-Free strategy and soldering details, please download the ON Semiconductor Soldering and Mounting Techniques Reference Manual, SOLDERRM/D.

NOTES:

1. DIMENSIONING AND TOLERANCING PER ANSI Y14.5M, 1982.
2. CONTROLLING DIMENSION: INCH.
3. DIMENSION b SHALL BE MEASURED WITHIN DIMENSION $L1$.

DIM	MILLIMETERS			INCHES		
	MIN	NOM	MAX	MIN	NOM	MAX
A	1.95	2.30	2.47	0.077	0.091	0.097
A1	0.05	0.10	0.20	0.002	0.004	0.008
b	1.96	2.03	2.20	0.077	0.080	0.087
c	0.15	0.23	0.31	0.006	0.009	0.012
D	3.30	3.56	3.95	0.130	0.140	0.156
E	4.06	4.32	4.60	0.160	0.170	0.181
H_E	5.21	5.44	5.60	0.205	0.214	0.220
L	0.76	1.02	1.60	0.030	0.040	0.063
L1	0.51 REF			0.020 REF		

GENERIC MARKING DIAGRAM*

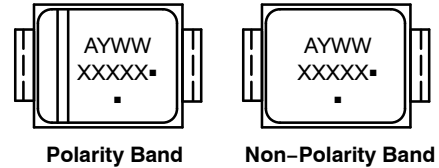

- XXXXX = Specific Device Code
 - A = Assembly Location
 - Y = Year
 - WW = Work Week
 - = Pb-Free Package
- (Note: Microdot may be in either location)

*This information is generic. Please refer to device data sheet for actual part marking. Pb-Free indicator, "G" or microdot "▪", may or may not be present.

DOCUMENT NUMBER:	98ASB42669B	Electronic versions are uncontrolled except when accessed directly from the Document Repository. Printed versions are uncontrolled except when stamped "CONTROLLED COPY" in red.
DESCRIPTION:	SMB	PAGE 1 OF 1

ON Semiconductor and are trademarks of Semiconductor Components Industries, LLC dba ON Semiconductor or its subsidiaries in the United States and/or other countries. ON Semiconductor reserves the right to make changes without further notice to any products herein. ON Semiconductor makes no warranty, representation or guarantee regarding the suitability of its products for any particular purpose, nor does ON Semiconductor assume any liability arising out of the application or use of any product or circuit, and specifically disclaims any and all liability, including without limitation special, consequential or incidental damages. ON Semiconductor does not convey any license under its patent rights nor the rights of others.

onsemi, **Onsemi**, and other names, marks, and brands are registered and/or common law trademarks of Semiconductor Components Industries, LLC dba "**onsemi**" or its affiliates and/or subsidiaries in the United States and/or other countries. **onsemi** owns the rights to a number of patents, trademarks, copyrights, trade secrets, and other intellectual property. A listing of **onsemi**'s product/patent coverage may be accessed at www.onsemi.com/site/pdf/Patent-Marking.pdf. **onsemi** reserves the right to make changes at any time to any products or information herein, without notice. The information herein is provided "as-is" and **onsemi** makes no warranty, representation or guarantee regarding the accuracy of the information, product features, availability, functionality, or suitability of its products for any particular purpose, nor does **onsemi** assume any liability arising out of the application or use of any product or circuit, and specifically disclaims any and all liability, including without limitation special, consequential or incidental damages. Buyer is responsible for its products and applications using **onsemi** products, including compliance with all laws, regulations and safety requirements or standards, regardless of any support or applications information provided by **onsemi**. "Typical" parameters which may be provided in **onsemi** data sheets and/or specifications can and do vary in different applications and actual performance may vary over time. All operating parameters, including "Typicals" must be validated for each customer application by customer's technical experts. **onsemi** does not convey any license under any of its intellectual property rights nor the rights of others. **onsemi** products are not designed, intended, or authorized for use as a critical component in life support systems or any FDA Class 3 medical devices or medical devices with a same or similar classification in a foreign jurisdiction or any devices intended for implantation in the human body. Should Buyer purchase or use **onsemi** products for any such unintended or unauthorized application, Buyer shall indemnify and hold **onsemi** and its officers, employees, subsidiaries, affiliates, and distributors harmless against all claims, costs, damages, and expenses, and reasonable attorney fees arising out of, directly or indirectly, any claim of personal injury or death associated with such unintended or unauthorized use, even if such claim alleges that **onsemi** was negligent regarding the design or manufacture of the part. **onsemi** is an Equal Opportunity/Affirmative Action Employer. This literature is subject to all applicable copyright laws and is not for resale in any manner.

ADDITIONAL INFORMATION

TECHNICAL PUBLICATIONS:

Technical Library: www.onsemi.com/design/resources/technical-documentation
onsemi Website: www.onsemi.com

ONLINE SUPPORT: www.onsemi.com/support

For additional information, please contact your local Sales Representative at www.onsemi.com/support/sales

Looking for pricing, stock, or lifecycle information?

Click below to explore more details on WIN SOURCE:

 [View MBRS130LT3G on WIN SOURCE](#)

 [ON Semiconductor](#) Information

Optimize Your Supply Chain with WIN SOURCE Solutions

-  Global Sourcing Solution
-  Obsolete Management
-  Cost Control Management
-  Shortage Management
-  Alternative Solution
-  Excess Inventory Management