



**THE DATASHEET OF
LQH43CN680K03L**



CHIP COIL (CHIP INDUCTORS) LQH43CN□□□□03L REFERENCE SPECIFICATION

1.Scope

This reference specification applies to LQH43CN Series, Chip coil (Chip Inductors).

2.Part Numbering

(ex) LQ H 43 C N 1R0 M 0 3 L
 Product ID Structure Dimension Applications Category Inductance Tolerance Features Electrode Packaging
 (L×W) and Characteristics L:Taping

3.Rating

- Operating Temperature Range -40 to +85°C
- Storage Temperature Range -40 to +85°C

Customer Part Number	MURATA Part Number	Inductance		DC Resistance (Ω max.)	Self Resonant Frequency (MHz min.)	*Rated Current (mA)
		(μH)	Tolerance (%)			
	LQH43CN1R0M03L	1.0	M:±20	0.08	100	1080
	LQH43CN1R5M03L	1.5		0.09	85	1000
	LQH43CN2R2M03L	2.2		0.11	60	900
	LQH43CN3R3M03L	3.3		0.13	47	800
	LQH43CN4R7M03L	4.7		0.15	35	750
	LQH43CN6R8M03L	6.8		0.20	30	720
	LQH43CN100K03L	10	K:±10	0.24	23	650
	LQH43CN150K03L	15		0.32	20	570
	LQH43CN220K03L	22		0.60	15	420
	LQH43CN330K03L	33		1.0	12	310
	LQH43CN470K03L	47		1.1	10	280
	LQH43CN680K03L	68		1.7	8.4	220
	LQH43CN101K03L	100		2.2	6.8	190
	LQH43CN151K03L	150		3.5	5.5	130
	LQH43CN221K03L	220		4.0	4.5	110
	LQH43CN331K03L	330		6.8	3.6	100
	LQH43CN471K03L	470	8.5	3.0	90	

*When applied Rated current to the Products, Inductance will be within ±10% of initial Inductance value.

When applied Rated current to the Products, temperature rise caused by self-generated heat shall be limited to 20°C max..

4. Testing Conditions

<Unless otherwise specified>

Temperature : Ordinary Temperature (15 to 35°C)
 Humidity : Ordinary Humidity (25 to 85 %(RH))

<In case of doubt>

Temperature : 20 ± 2°C
 Humidity : 60 to 70 %(RH)
 Atmospheric Pressure : 86 to 106 kPa

5.Appearance and Dimensions

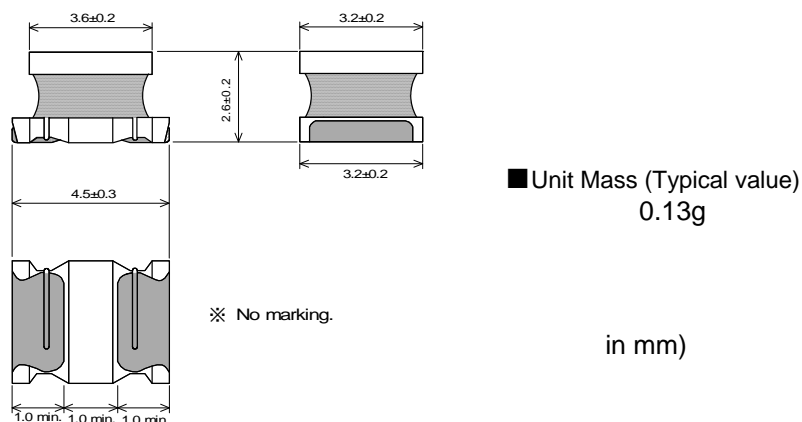

6.Electrical Performance

No.	Item	Specification	Test Method
6.1	Inductance	Inductance shall meet item 3.	Measuring Equipment: Agilent 4192A or equivalent Measuring Frequency: 1MHz / 1.0 to 330μH 1kHz / 470μH
6.2	DC Resistance	DC Resistance shall meet item 3.	Measuring Equipment: Digital multi meter
6.3	Self Resonant Frequency(S.R.F)	S.R.F shall meet item 3.	Measuring Equipment: Agilent 4991A or equivalent
6.4	Rated Current	Self temperature rise shall be limited to 20°C max. Inductance Change : within ± 10%	The rated current is applied.

7.Mechanical Performance

No.	Item	Specification	Test Method
7.1	Shear Test	Chip coil shall not be damaged.	Substrate: Glass-epoxy substrate Applied Direction : Chip Coil  Force: 20N Hold Duration: 5±1 s
7.2	Bending Test		Substrate: Glass-epoxy substrate (100 × 40 × 1.6mm) Speed of Applying Force: 1mm / s Deflection: 2mm Hold Duration: 30 s Pressure jig  Deflection Product (in mm)
7.3	Vibration		Oscillation Frequency: 10 to 55 to 10Hz for 1 minute Total Amplitude: 1.5mm Testing Time: A period of 2 hours in each of 3 mutually perpendicular directions. (Total 6 hours)

No.	Item	Specification	Test Method
7.4	Solderability	The wetting area of the electrode shall be at least 90% covered with new solder coating.	Flux: Ethanol solution of rosin, 25(wt)% (Immersed for 5s to 10s) Solder: Sn-3.0Ag-0.5Cu Pre-Heating: 150±10°C / 60 to 90seconds Solder Temperature: 240±5°C Immersion Time: 3±1 s
7.5	Resistance to Soldering Heat	Appearance:No damage Inductance Change : within ± 5%	Flux: Ethanol solution of rosin, 25(wt)% (Immersed for 5s to 10s) Solder: Sn-3.0Ag-0.5Cu Pre-Heating: 150±10°C / 60 to 90seconds Solder Temperature: 270±5°C Immersion Time: 10±1 s Then measured after exposure in the room condition for 24±2 hours.

8.Environmental Performance (It shall be soldered on the substrate.)

No.	Item	Specification	Test Method
8.1	Heat Resistance	Appearance:No damage Inductance Change : within ±5%	Temperature: 85±2°C Time: 1000± ⁴⁸ ₀ hours Then measured after exposure in the room condition for 24±2 hours.
8.2	Cold Resistance		Temperature: -40±2°C Time: 1000± ⁴⁸ ₀ hours Then measured after exposure in the room condition for 24±2 hours.
8.3	Humidity		Temperature: 40±2°C Humidity: 90 to 95%(RH) Time: 1000± ⁴⁸ ₀ hours Then measured after exposure in the room condition for 24±2 hours.
8.4	Temperature Cycle		1 cycle: step 1 : -40±2°C / 30±3 min step 2 : Ordinary temp. / 10 to 15 min step 3 : +85±2°C / 30±3 min step 4 : Ordinary temp. / 10 to 15 min Total of 10 cycles Then measured after exposure in the room condition for 24±2 hours.

9. Specification of Packaging

9.1 Appearance and Dimensions of plastic tape

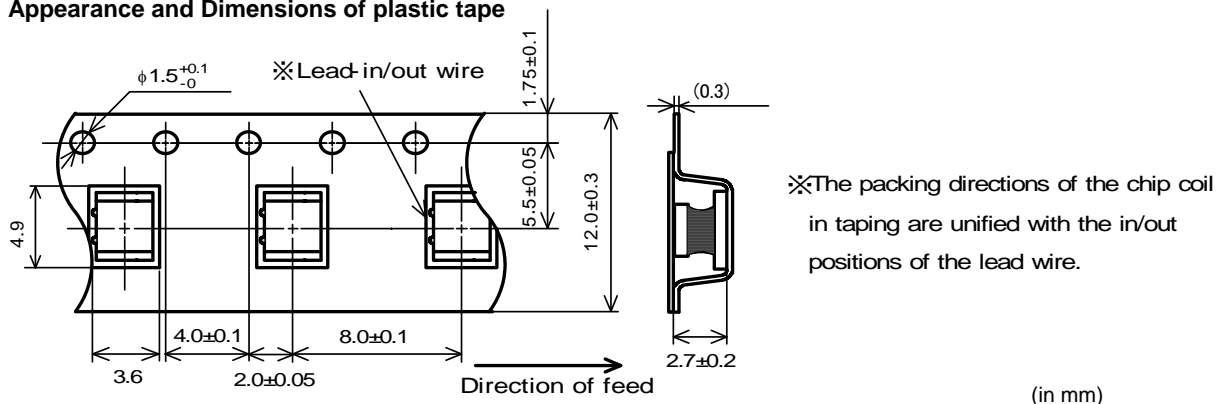

Dimension of the Cavity is measured at the bottom side.

9.2 Specification of Taping

- (1) Packing quantity (standard quantity)
500 pcs / reel
- (2) Packing Method
Products shall be packed in the each embossed cavity of plastic tape and sealed by cover tape.
- (3) Sprocket hole
The sprocket holes are to the right as the tape is pulled toward the user.
- (4) Spliced point
Plastic tape and Cover tape has no spliced point.
- (5) Missing components number
Missing components number within 0.1 % of the number per reel or 1 pc., whichever is greater, and are not continuous. The specified quantity per reel is kept.

9.3 Pull Strength

Embossed carrier tape	10N min.
Cover tape	5N min.

9.4 Peeling off force of cover tape

Speed of Peeling off	300mm/min
Peeling off force	0.2 to 0.7N (minimum value is typical)

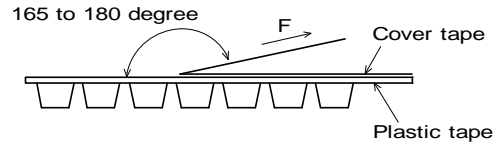

9.5 Dimensions of Leader-tape, Trailer and Reel

There shall be leader-tape (cover tape) and trailer-tape (empty tape) as follows.

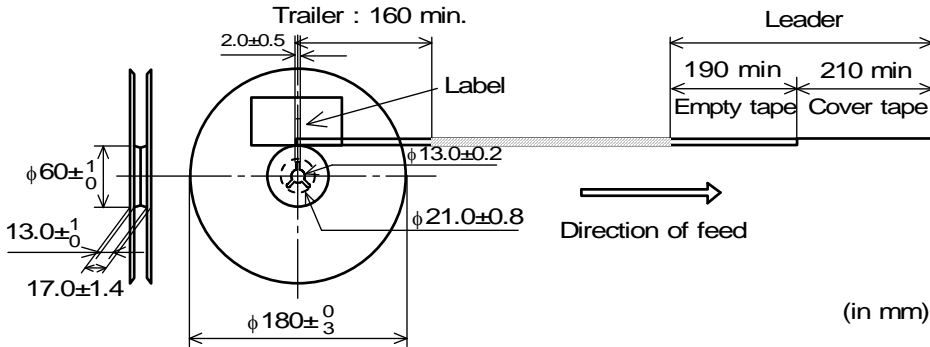

9.6 Marking for reel

Customer part number, MURATA part number, Inspection number(*1), RoHS marking(*2), Quantity etc ...

*1) <Expression of Inspection No.>

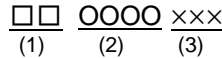

(1) Factory Code

(2) Date

First digit : Year / Last digit of year

Second digit : Month / Jan. to Sep. → 1 to 9, Oct. to Dec. → O, N, D

Third, Fourth digit : Day

(3) Serial No.

*2) « Expression of RoHS marking » ROHS - Y (Δ)
(1) (2)

(1) RoHS regulation conformity parts.

(2) MURATA classification number

9.7 Marking for Outside package (corrugated paper box)

Customer name, Purchasing order number, Customer part number, MURATA part number, RoHS marking (*2), Quantity, etc ...

9.8. Specification of Outer Case

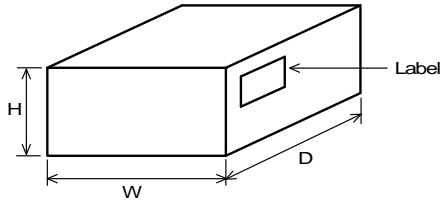

Outer Case Dimensions (mm)			Standard Reel Quantity in Outer Case (Reel)
W	D	H	
186	186	93	4

* Above Outer Case size is typical. It depends on a quantity of an order

10. ⚠ Caution

Limitation of Applications

Please contact us before using our products for the applications listed below which require especially high reliability for the prevention of defects which might directly cause damage to the third party's life, body or property.

- | | |
|--|--|
| (1) Aircraft equipment | (7) Traffic signal equipment |
| (2) Aerospace equipment | (8) Disaster prevention / crime prevention equipment |
| (3) Undersea equipment | (9) Data-processing equipment |
| (4) Power plant control equipment | (10) Applications of similar complexity and /or reliability requirements to the applications listed in the above |
| (5) Medical equipment | |
| (6) Transportation equipment (vehicles, trains, ships, etc.) | |

11. Notice

This product is designed for solder mounting.
Please consult us in advance for applying other mounting method such as conductive adhesive.

11.1 Land pattern designing

Recommended land patterns for flow and reflow soldering are as follows:

These have been designed for Electric characteristics and solderability.

Please follow the recommended patterns. Otherwise, their performance which includes electrical performance or solderability may be affected, or result to "position shift" in soldering process.

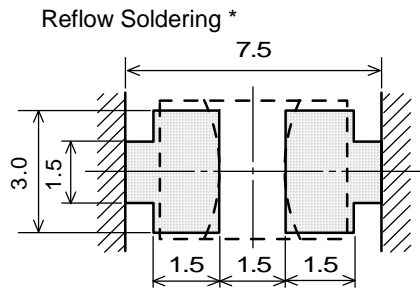
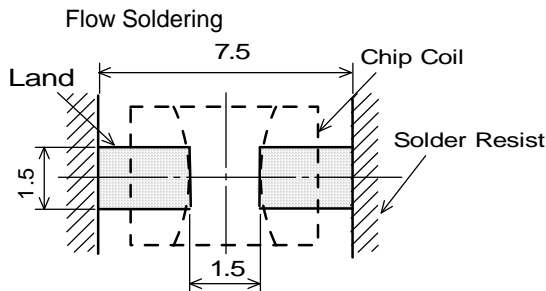

(in mm)

* Applicable to flow soldering.

11.2 Flux, Solder

Flux	<ul style="list-style-type: none"> • Use rosin-based flux. • Don't use highly acidic flux with halide content exceeding 0.2(wt)% (chlorine conversion value). • Don't use water-soluble flux.
Solder	<ul style="list-style-type: none"> • Use Sn-3.0Ag-0.5Cu solder • Standard thickness of solder paste : 200 μ m to 300 μ m

Other flux (except above) Please contact us for details, then use.

11.3 Flow soldering conditions / Reflow soldering conditions

- Pre-heating should be in such a way that the temperature difference between solder and product surface is limited to 150°C max. Cooling into solvent after soldering also should be in such a way that the temperature difference is limited to 100°C max.
Insufficient pre-heating may cause cracks on the product, resulting in the deterioration of product quality.
- Standard soldering profile and the limit soldering profile is as follows.
The excessive limit soldering conditions may cause leaching of the electrode and / or resulting in the deterioration of product quality.

soldering profile

(1)Flow soldering profile



	Standard Profile	Limit Profile
Pre-heating	150°C、60s min.	
Heating	250°C、4s~6s	265°C±3°C、5s
Cycle of flow	2 times	1 time

(2)Reflow soldering profile

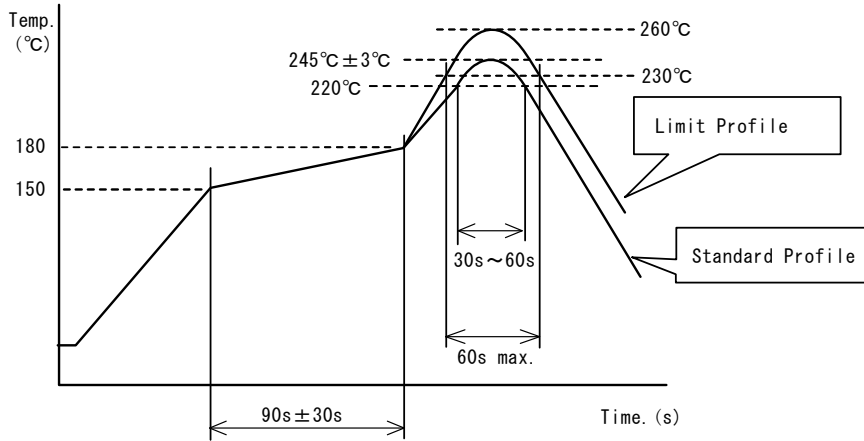

	Standard Profile	Limit Profile
Pre-heating	150~180°C、90s±30s	
Heating	above 220°C、30s~60s	above 230°C、60s max.
Peak temperature	245±3°C	260°C、10s
Cycle of reflow	2 times	1 time

11.4 Reworking with soldering iron.

The following conditions must be strictly followed when using a soldering iron.

Pre-heating	150°C, 1 min
Tip temperature	350°C max.
Soldering iron output	80W max.
Tip diameter	φ 3mm max.
Soldering time	3(+1,-0)s
Times	2 times

Note : Do not directly touch the products with the tip of the soldering iron in order to prevent the crack on the products due to the thermal shock.

11.5 Solder Volume

- Solder shall be used not to be exceeded the upper limits as shown below.
- Accordingly increasing the solder volume, the mechanical stress to Chip is also increased. Exceeding solder volume may cause the failure of mechanical or electrical performance.

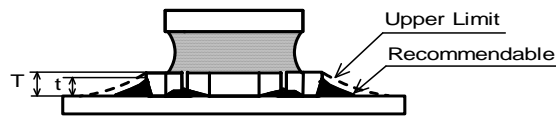

$$\frac{1}{3}T \leq t \leq T$$

(T: Lower flange thickness)

11.6 Product's location

The following shall be considered when designing and laying out P.C.B.'s.

- (1) P.C.B. shall be designed so that products are not subject to the mechanical stress due to warping the board.



Products shall be located in the sideways direction (Length: $a < b$) to the mechanical stress.

- (2) Products location on P.C.B. separation

Products (A,B,C,D) shall be located carefully so that products are not subject to the mechanical stress due to warping the board. Because they may be subjected the mechanical stress in order of $A > C > B \cong D$.

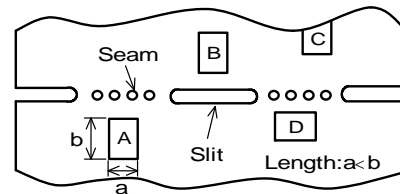

11.7 Cleaning Conditions

Products shall be cleaned on the following conditions.

- (1) Cleaning temperature shall be limited to 60°C max. (40°C max for IPA.)
- (2) Ultrasonic cleaning shall comply with the following conditions with avoiding the resonance phenomenon at the mounted products and P.C.B.

Power : 20 W / l max. Frequency : 28kHz to 40kHz Time : 5 minutes max.
- (3) Cleaner
 1. Alternative cleaner
 - Isopropyl alcohol (IPA)
 2. Aqueous agent
 - PINE ALPHA ST-100S
- (4) There shall be no residual flux and residual cleaner after cleaning.

In the case of using aqueous agent, products shall be dried completely after rinse with de-ionized water in order to remove the cleaner.
- (5) Other cleaning

Please contact us.

11.8 Resin coating

The inductance value may change due to high cure-stress of resin to be used for coating/molding products. An open circuit issue may occur by mechanical stress caused by the resin, amount/cured shape of resin, or operating condition etc. Some resin contains some impurities or chloride possible to generate chlorine by hydrolysis under some operating condition may cause corrosion of wire of coil, leading to open circuit. So, please pay your careful attention when you select resin in case of coating/molding the products with the resin. Prior to use the coating resin, please make sure no reliability issue is observed by evaluating products mounted on your board.

11.9 Caution for use

- Sharp material such as a pair of tweezers or other material such as bristles of cleaning brush, shall not be touched to the winding portion to prevent the breaking of wire.
- Mechanical shock should not be applied to the products mounted on the board to prevent the breaking of the core.

11.10 Handling of a substrate

After mounting products on a substrate, do not apply any stress to the product caused by bending or twisting to the substrate when cropping the substrate, inserting and removing a connector from the substrate or tightening screw to the substrate.

Excessive mechanical stress may cause cracking in the product.

Bending**Twisting****11.11 Storage and Handling Requirements****(1) Storage period**

Use the products within 12 months after delivered.

Solderability should be checked if this period is exceeded.

(2) Storage conditions

- Products should be stored in the warehouse on the following conditions.

Temperature : -10 ~ 40°C

Humidity : 15 to 85% relative humidity No rapid change on temperature and humidity

The electrode of the products is coated with solder. Don't keep products in corrosive gases such as sulfur, chlorine gas or acid, or it may cause oxidization of electrode, resulting in poor solderability.

- Products should not be stored on bulk packaging condition to prevent the chipping of the core and the breaking of winding wire caused by the collision between the products.
- Products should be stored on the palette for the prevention of the influence from humidity, dust and so on.
- Products should be stored in the warehouse without heat shock, vibration, direct sunlight and so on.

(3) Handling Condition



Care should be taken when transporting or handling product to avoid excessive vibration or mechanical shock.

12. ⚠ Note

- (1) Please make sure that your product has been evaluated in view of your specifications with our product being mounted to your product.
- (2) You are requested not to use our product deviating from the reference specifications.
- (3) The contents of this reference specification are subject to change without advance notice. Please approve our product specifications or transact the approval sheet for product specifications before ordering.

Looking for pricing, stock, or lifecycle information?

Click below to explore more details on WIN SOURCE:

-  [View LQH43CN680K03L on WIN SOURCE](#)
-  [Murata Electronics North America Information](#)

Optimize Your Supply Chain with WIN SOURCE Solutions

-  Global Sourcing Solution
-  Obsolete Management
-  Cost Control Management
-  Shortage Management
-  Alternative Solution
-  Excess Inventory Management