



**THE DATASHEET OF
HT7150-1**



Product introduction

The 71XX series is a low-power high-voltage regulator manufactured by CMOS process. The maximum input voltage is 30V and the output voltage range is 1.5v-12.0v. It has the characteristics of high precision output voltage, very low power supply current and very low drop voltage.

Product features

- Low power consumption: $\leq 3\mu A$
- Low drop voltage: typical value 0.1V
- Low temperature bleaching: typical 50 ppm / °C
- High input voltage: up to 30V
- High precision output voltage: tolerance of + 3%
- Package form: TO-92, sot89-3, sot-23-3

Product use

- Battery power supply equipment
- Audio / video equipment
- Various communication equipment
- Security monitoring equipment

Package form and pin function definition

Pin number			Pin define	Functional specifications
TO-92	SOT89-3	SOT23-3		
1	1	1	GND	Chip ground terminal
2	2	2	VIN	Start input
3	3	3	VOUT	Chip output terminal

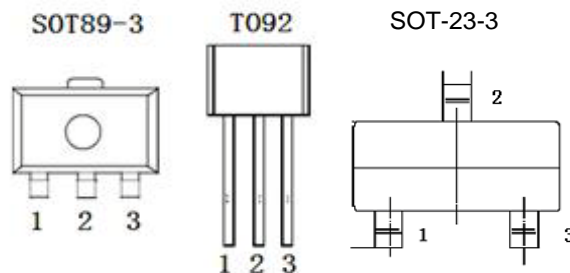

Model selection

name	model	Maximum input voltage (V)	Output voltage (V)	tolerance	Packaging form
71XX	7130	30	3.0	$\pm 3\%$	TO 92 SOT89-3 SOT-23-3
	7133	30	3.3	$\pm 3\%$	
	7136	30	3.6	$\pm 3\%$	
	7144	30	4.4	$\pm 3\%$	
	7150	30	5.0	$\pm 3\%$	

■ Principle block diagram

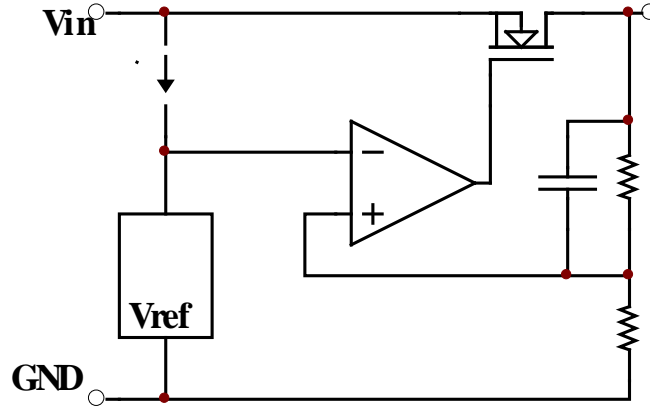

■ Limit parameter

project	Symbol	parameter	Limit value	Company
Voltage	VIN	Maximum input voltage	30	V
power waste	PD	power waste	400	mW
temperature	Tw	working temperature	-25~70	°C
	Tc	Storage temperature	-50~125	°C
	Th	welding temperature	260	°C,10s

■ Electrical properties

7130 (T_{OPT}=25°C)

Symbol	parameter	Test conditions	Min	Typical value	Max	Company
V _{OUT}	Output voltage	V _{IN} =5V, I _{OUT} =10mA	2.91	3	3.09	V
I _{OUT}	Output current	V _{IN} =5V	60	100		mA
ΔV _{OUT}	Load regulation	V _{IN} =5V, 1mA≤I _{OUT} ≤20mA	—	100	150	mV
V _{DIF}	Voltage sag	I _{OUT} =1mA	—	100	—	mV
I _{SS}	Quiescent current	Vin = 5V, no load	—	2	3	μA
ΔV _{OUT} / (ΔV _{IN} *V _{OUT})	Line Regulation	4V≤V _{IN} ≤30V, I _{OUT} =1mA	—	0.2	—	%/V
V _{IN}	input voltage	—	—	—	30	V
ΔV _{OUT} / ΔTa	temperature coefficient	V _{IN} =5V, I _{OUT} =10mA 0°C≤Ta≤70°C	—	±0.45	—	mV/°C

7133 (T_{OPT}=25°C)

Symbol	Parameter	Test conditions	Min	Typical value	Max	Company
V _{OUT}	Output voltage	V _{IN} =5.5V, I _{OUT} =10mA	3.201	3.3	3.399	V
I _{OUT}	Output current	V _{IN} =5.5V	60	100	—	mA
ΔV _{OUT}	Load regulation	V _{IN} =5.5V, 1mA≤I _{OUT} ≤30mA	—	100	150	mV
V _{DIF}	Voltage sag	I _{OUT} =1mA	—	100	—	mV
I _{SS}	Quiescent current	V _{IN} = 5.5V, no load	—	2	3	μA
ΔV _{OUT} /(ΔV _{IN} *V _{OUT})	Line Regulation	4.5V≤V _{IN} ≤30V, I _{OUT} =1mA	—	0.2	—	%/V
V _{IN}	Input voltage	—	—	—	30	V
ΔV _{OUT} /ΔTa	Temperature coefficient	V _{IN} =5.5V, I _{OUT} =10mA, 0°C≤Ta≤70°C	—	±0.5	—	mV/°C

7136 (T_{OPT}=25°C)

Symbol	Parameter	Test conditions	Min	Typical value	Max	Company
V _{OUT}	Output voltage	V _{IN} =5.6V, I _{OUT} =10mA	3.492	3.6	3.708	V
I _{OUT}	Output current	V _{IN} =5.6V	60	100	—	mA
ΔV _{OUT}	Load regulation	V _{IN} =5.6V, 1mA≤I _{OUT} ≤30mA	—	100	150	mV
V _{DIF}	Voltage sag	I _{OUT} =1mA	—	100	—	mV
I _{SS}	Quiescent current	V _{IN} = 5.6V, no load	—	2	3	μA
ΔV _{OUT} /(ΔV _{IN} *V _{OUT})	Line Regulation	4.6V≤V _{IN} ≤30V, I _{OUT} =1mA	—	0.2	—	%/V
V _{IN}	Input voltage	—	—	—	30	V
ΔV _{OUT} /ΔTa	Temperature coefficient	V _{IN} =5.6V, I _{OUT} =10mA, 0°C≤Ta≤70°C	—	±0.6	—	mV/°C

7144 (T_{OPT}=25°C)

Symbol	Parameter	Test conditions	Min	Typical value	Max	Company
V _{OUT}	Output voltage	V _{IN} =6.4V, I _{OUT} =10mA	4.268	4.4	4.532	V
I _{OUT}	Output current	V _{IN} =6.4V	60	100	—	mA
ΔV _{OUT}	Load regulation	V _{IN} =6.4V, 1mA≤I _{OUT} ≤30mA	—	100	150	mV
V _{DIF}	Voltage sag	I _{OUT} =1mA	—	100	—	mV
I _{SS}	Quiescent current	V _{IN} = 6.4V, no load	—	2	3	μA
ΔV _{OUT} /(ΔV _{IN} *V _{OUT})	Line Regulation	5.4V≤V _{IN} ≤30V, I _{OUT} =1mA	—	0.2	—	%/V
V _{IN}	Input voltage	—	—	—	30	V
ΔV _{OUT} /ΔTa	Temperature coefficient	V _{IN} =6.4V, I _{OUT} =10mA, 0°C≤Ta≤70°C	—	±0.7	—	mV/°C

7150 (T_{OPT}=25°C)

Symbol	Parameter	Test conditions	Min	Typical value	Max	Company
V _{OUT}	Output voltage	V _{IN} =7V, I _{OUT} =10mA	4.85	5	5.15	V
I _{OUT}	Output current	V _{IN} =7V	60	100	—	mA
ΔV _{OUT}	Load regulation	V _{IN} =7V, 1mA≤I _{OUT} ≤30mA	—	100	—	mV
V _{DIF}	Voltage sag	I _{OUT} =1mA	—	100	—	mV
I _{SS}	Quiescent current	V _{IN} = 7V, no load	—	2	3	μA
ΔV _{OUT} /(ΔV _{IN} *V _{OUT})	Line Regulation	6V≤V _{IN} ≤30V, I _{OUT} =1mA	—	0.2	—	%/V
V _{IN}	Input voltage	—	—	—	30	V
ΔV _{OUT} /ΔT _a	Temperature coefficient	V _{IN} =7V, I _{OUT} =10mA, 0°C≤T _a ≤70°C	—	±0.75	—	mV/°C

■ Application circuit

1. Basic circuit

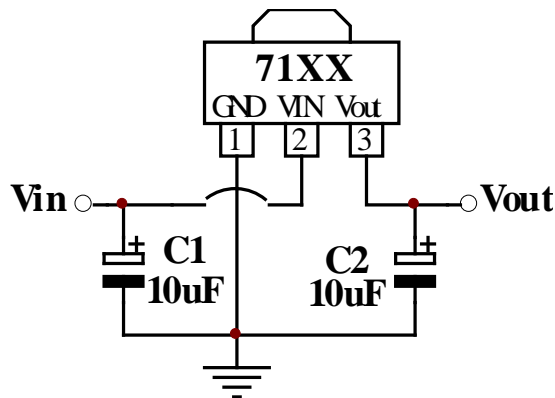

2. High output current regulator

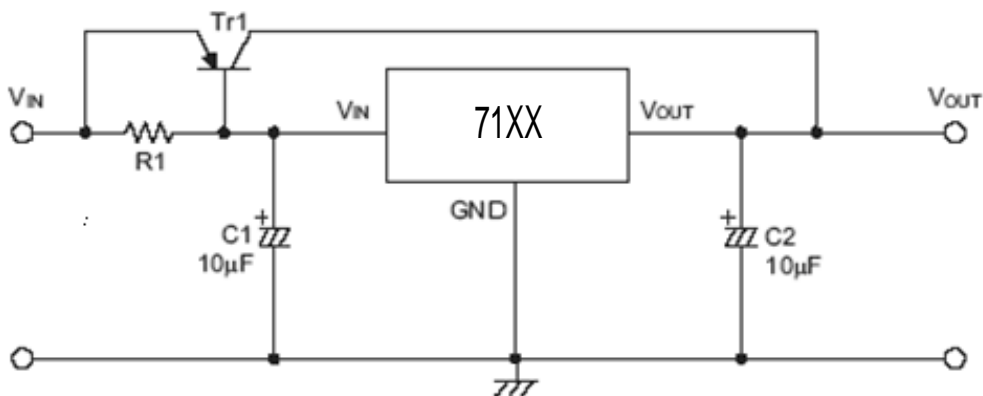

3. Short circuit protection circuit

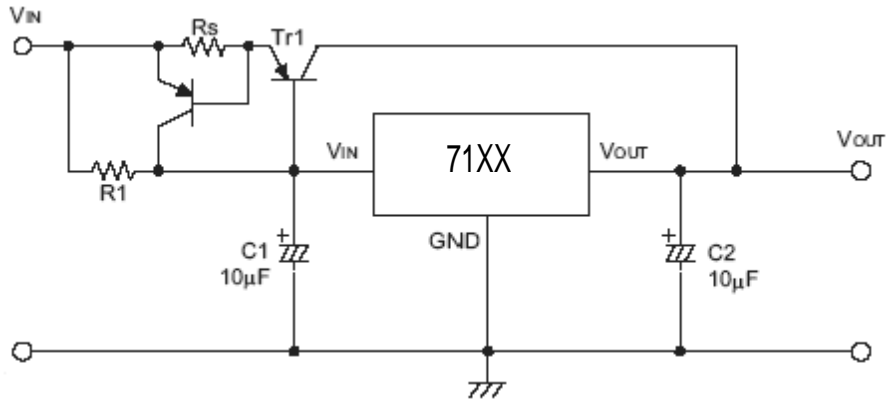

4. Circuit for increasing output voltage (1)

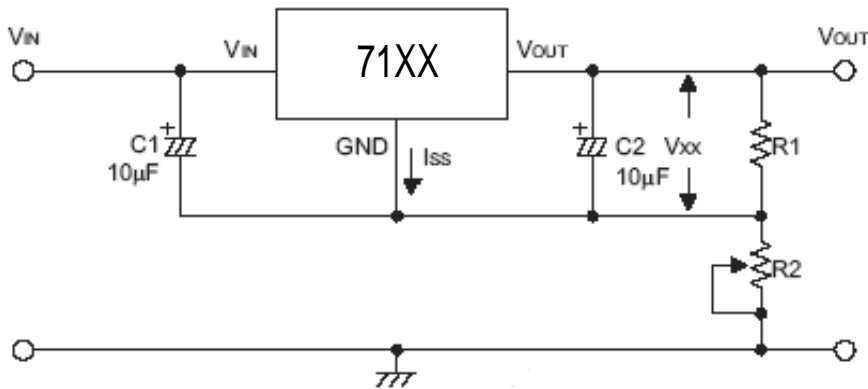

$$V_{OUT} = V_{XX} (1 + R2/R1) + I_{SS} * R2$$

5. Circuit for increasing output voltage (2)

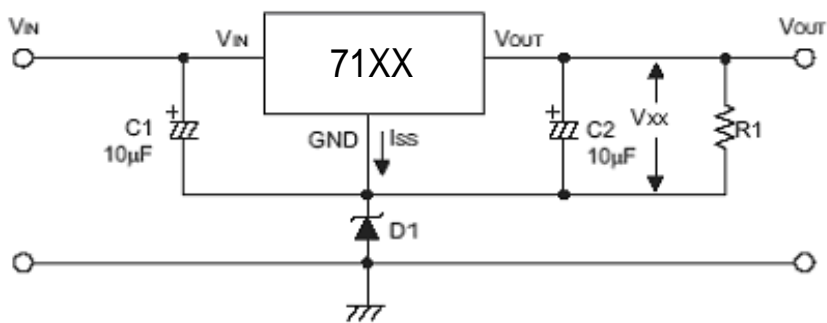

$$V_{OUT} = V_{XX} + V_{D1}$$

6. Current regulating circuit

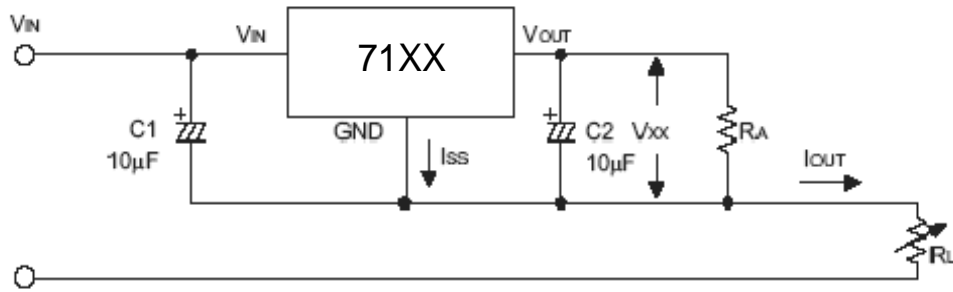

$$I_{OUT} = V_{XX}/R_X + I_{SS}$$

7. Dual output circuit

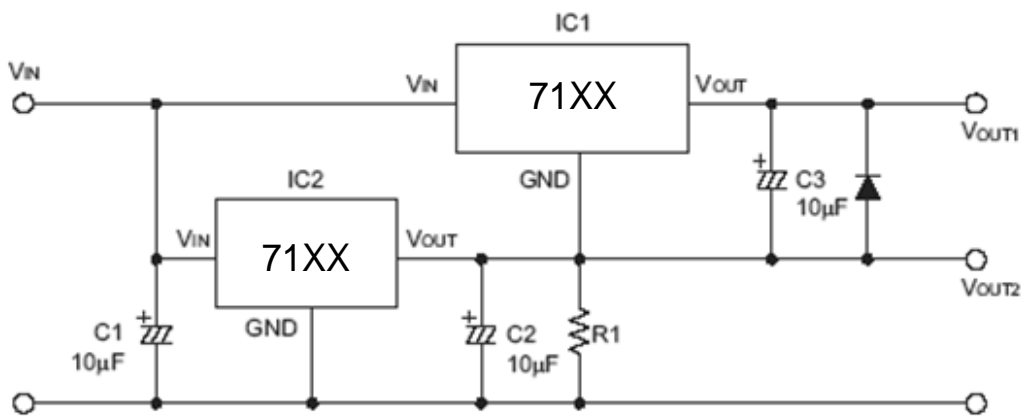

Note: "xx" Represents the output voltage

■ Encapsulation information

T0-92

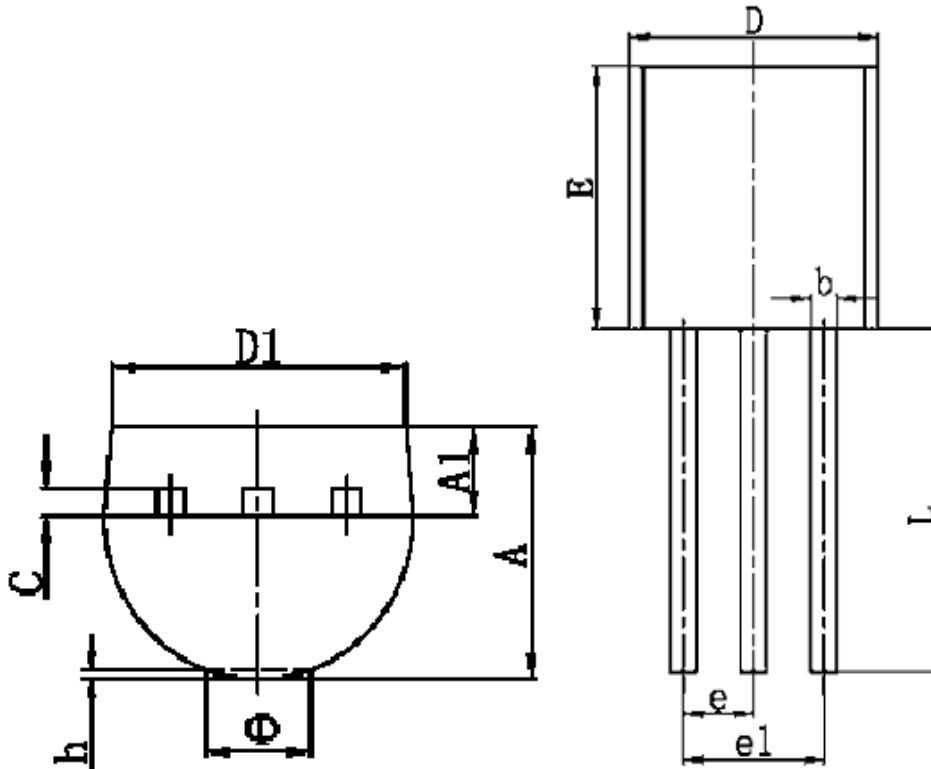

符号	最小值 (mm)	最大值 (mm)
A	3.300	3.700
A1	1.100	1.400
b	0.380	0.550
c	0.360	0.510
D	4.400	4.700
D1	3.430	
E	4.300	4.700
e	1.270 TYP	
e1	2.440	2.640
L	14.100	14.500
Φ		1.600
h	0.000	0.380

SOT-89-3

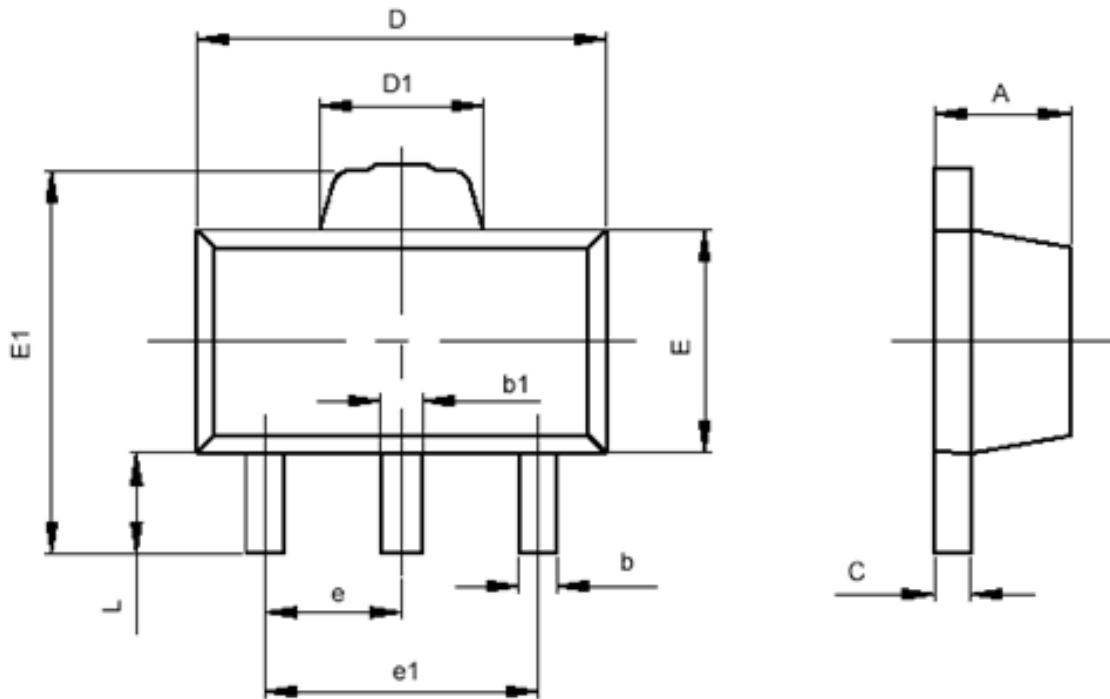

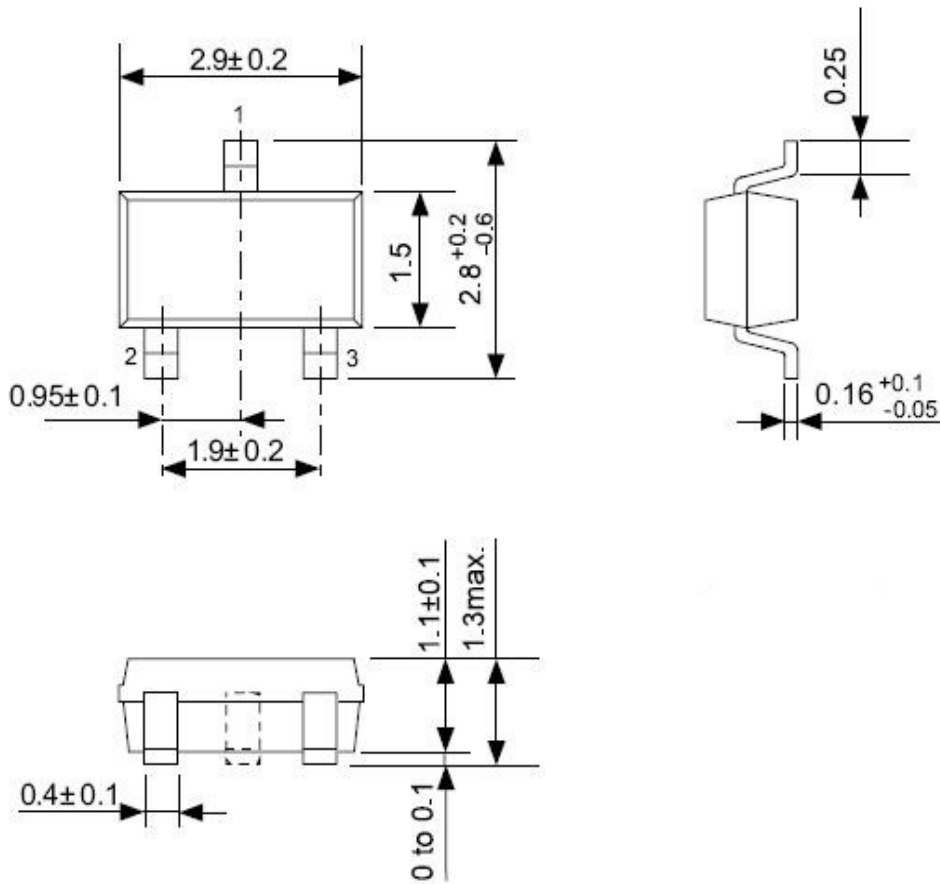

符号	最小值 (mm)	最大值 (mm)
A	1.400	1.600
b	0.320	0.520
b1	0.360	0.560
c	0.350	0.440
D	4.400	4.600
D1	1.400	1.800
E	2.300	2.600
E1	3.940	4.250
e	1.500TYP	
e1	2.900	3.100
L	0.900	1.100

SOT-23-3









Looking for pricing, stock, or lifecycle information?

Click below to explore more details on WIN SOURCE:

-  [View HT7150-1 on WIN SOURCE](#)
-  [NXP / Nexperia Information](#)

Optimize Your Supply Chain with WIN SOURCE Solutions

-  Global Sourcing Solution
-  Obsolete Management
-  Cost Control Management
-  Shortage Management
-  Alternative Solution
-  Excess Inventory Management