







THE DATASHEET OF H5007NL

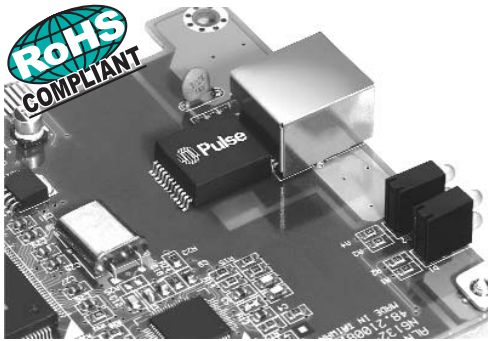

1000BASE-T MAGNETICS MODULES

Designed to Support 1:1 Turns Ratio Transceivers



-  RoHS-5 peak reflow temperature rating 235°C
-  RoHS-6 peak reflow temperature rating 245°C
-  Meets IEEE 802.3 specification

Electrical Specifications @ 25°C — Operating Temperature 0°C to 70°C

RoHS-5 ⁴ Compliant Part Number	RoHS-6 ⁵ Compliant Part Number	Number of Ports	Insertion Loss (dB MAX)	Return Loss (dB MIN)					Differential to Common Mode Rejection (dB MIN)			Crosstalk (dB MIN)			Hipot (V _{RMS} MIN)
				1-100MHz	1-30MHz	40MHz	50MHz	60-80MHz	100MHz	30MHz	60MHz	100MHz	30MHz	60MHz	
H5004 ^{3c}	H5004NL ^{3d}	1	1	-18	-18	-16	-12	-10	-43	-37	-33	-43	-37	-33	1500
HX5004 ^{1,3c}	HX5004NL ^{1,3d}	1	1	-18	-18	-16	-12	-10	-43	-37	-33	-43	-37	-33	1500
H5007 ^{3c}	H5007NL ^{3d}	1	1	-18	-18	-16	-12	-10	-43	-37	-33	-43	-37	-33	1500
H5008 ^{3a}	H5008NL ^{3a}	1	1	-18	-18	-16	-12	-10	-43	-37	-33	-43	-37	-33	1500
HX5008 ^{1,3a}	HX5008NL ^{1,3a}	1	1	-18	-18	-16	-12	-10	-43	-37	-33	-43	-37	-33	1500
H5009 ^{3a}	H5009NL ^{3a}	1	1	-18	-18	-16	-12	-10	-43	-37	-33	-43	-37	-33	1500
H5012 ^{3a}	H5012NL ^{3a}	2	1.4	-16	-14.4	-13.1	-12	-10	-45	-40	-35	-43.5	-37.5	-33	1500
H5014 ^{3a}	H5014NL ^{3a}	2	1.4	-16	-14.4	-13.1	-12	-10	-45	-40	-35	-43.5	-37.5	-33	1500
HX5014 ^{1,3a}	HX5014NL ^{1,3a}	2	1.4	-16	-14.4	-13.1	-12	-10	-45	-40	-35	-43.5	-37.5	-33	1500
H5015 ^{3a}	H5015NL ^{3a}	1	1	-18	-18	-16	-12	-10	-43	-37	-33	-43	-37	-33	1500
H5020 ^{3a}	H5020NL ^{3a}	2	1	-18	-14.4	-13.1	-12	-10	-40	-35	-30	-40	-33	-28	1500
HX5020 ^{1,3a}	HX5020NL ^{1,3a}	2	1	-18	-14.4	-13.1	-12	-10	-40	-35	-30	-40	-33	-28	1500
H5089 ^{3a}	H5089NL ^{3a}	2	1.4	-16	-14.4	-13.1	-12	-10	-45	-40	-35	-43.5	-37.5	-33	1500

- HX:** Extended temperature version -40°C to +85°C
- For Tape & Reel packaging, add a "T" suffix at the end of the part number, e.g. H5007T.
- MSL=Moisture Sensitivity Level: a=1 b=2 c=3 d=4
- RoHS-5:** Product does not contain 5 out of the 6 banned substances specified in the RoHS directive (product contains lead in applications considered solder).
- RoHS-6:** Product does not contain 5 out of the 6 banned substances specified in the RoHS directive. Some internal connections may contain lead in high-temperature solder (solder alloys containing more than 85% lead)

Mechanicals

H5004, HX5004, H5007*

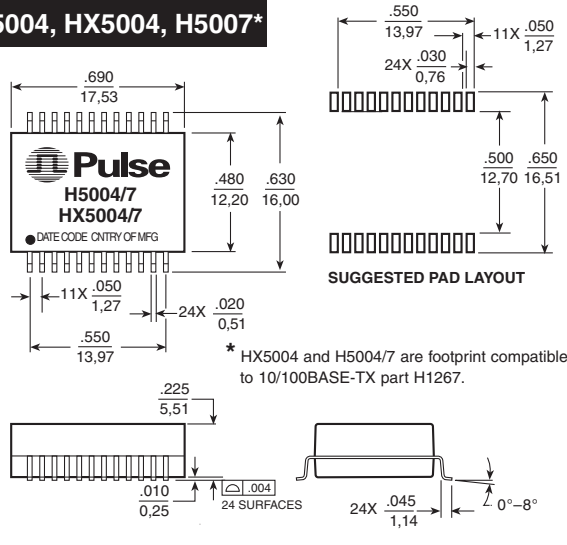

H5008, HX5008, H5009

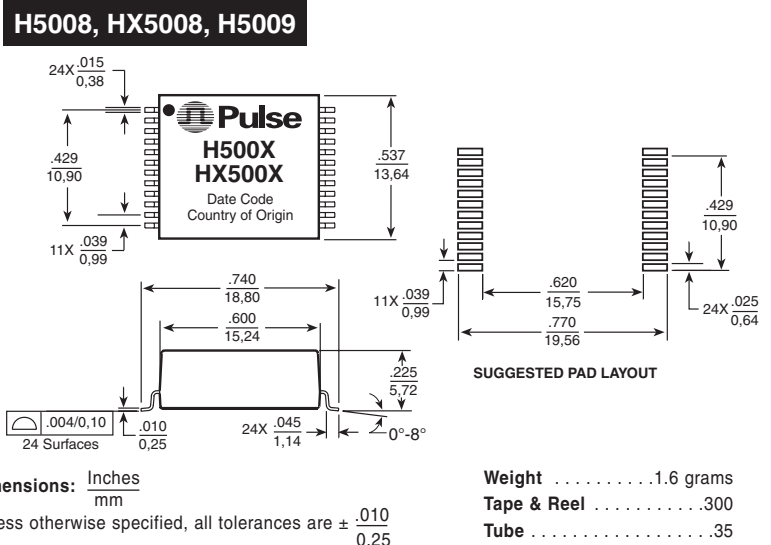

1000BASE-T MAGNETICS MODULES

Designed to Support 1:1
Turns Ratio Transceivers



Mechanicals (continued)

H5012, H5014, HX5014, H5089

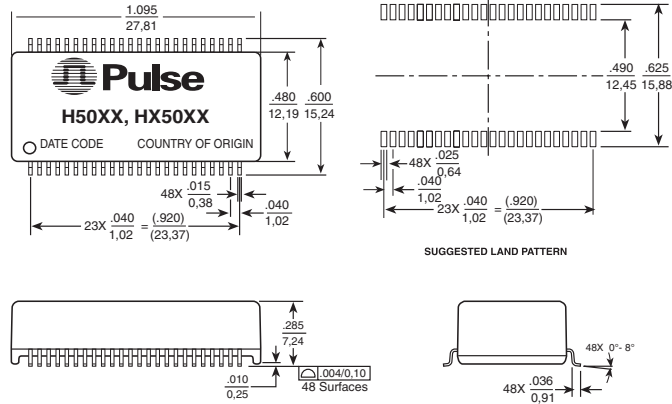

Weight 4.0 grams
Tape & Reel250/reel
Tube15/tube

Dimensions: $\frac{\text{Inches}}{\text{mm}}$

Unless otherwise specified, all tolerances are $\pm \frac{.010}{0,25}$

H5020, HX5020

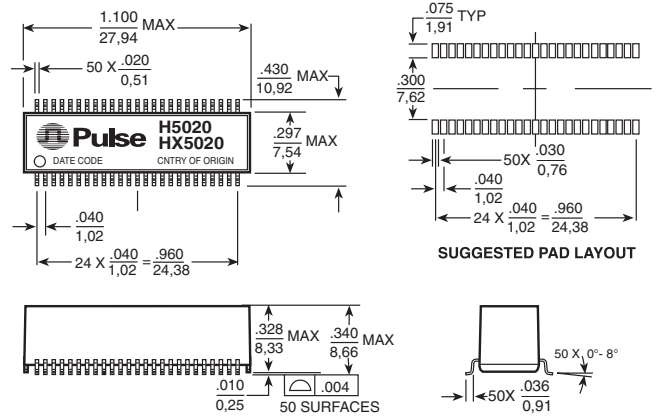

Weight 1.6 grams
Tape & Reel250/reel
Tube15/tube

Mechanicals (continued)

Schematics

H5015

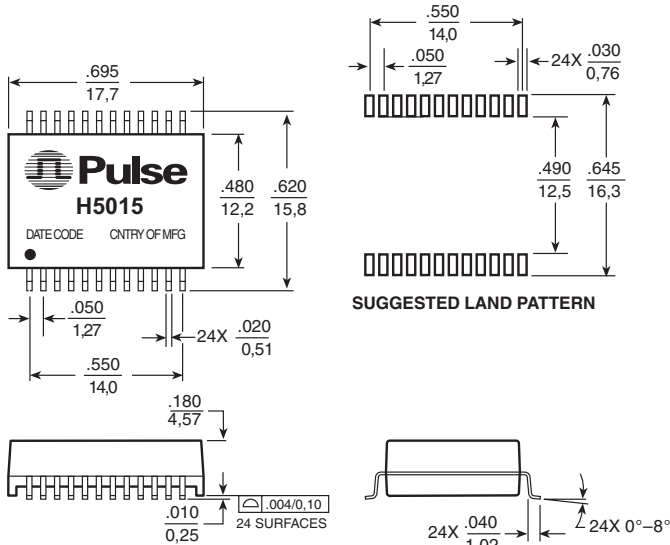

Weight 1.5 grams
Tape & Reel400/reel

Dimensions: $\frac{\text{Inches}}{\text{mm}}$

Unless otherwise specified, all tolerances are $\pm \frac{.005}{0,13}$

H5004, HX5004, H5009

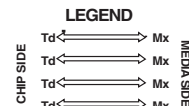
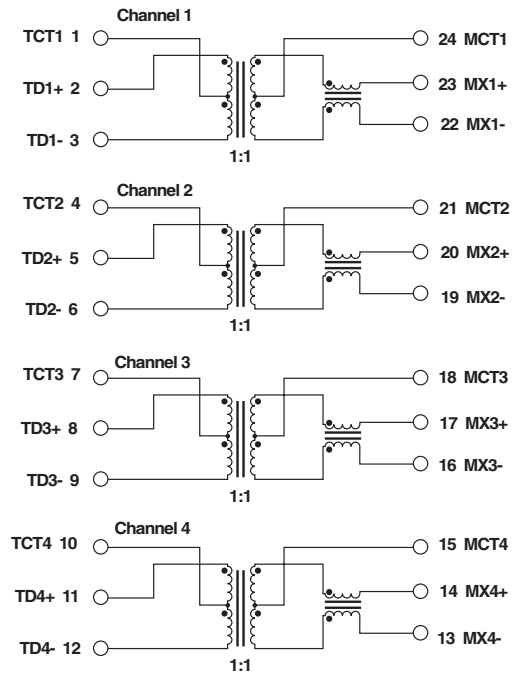

1000BASE-T MAGNETICS MODULES

Designed to Support 1:1
Turns Ratio Transceivers



Schematics (continued)

H5007*, H5008, HX5008, H5015

H5012, H5089

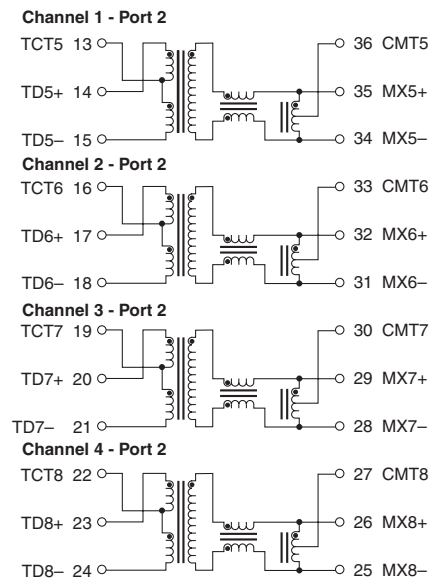
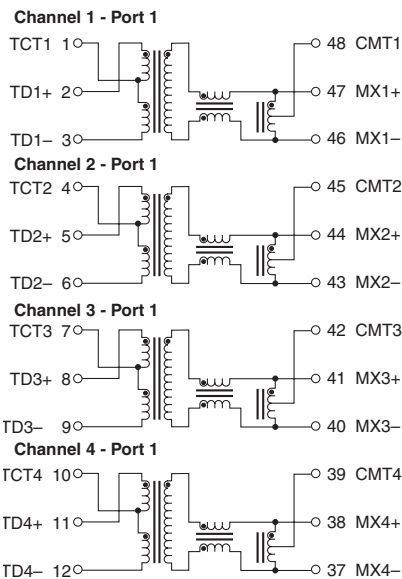
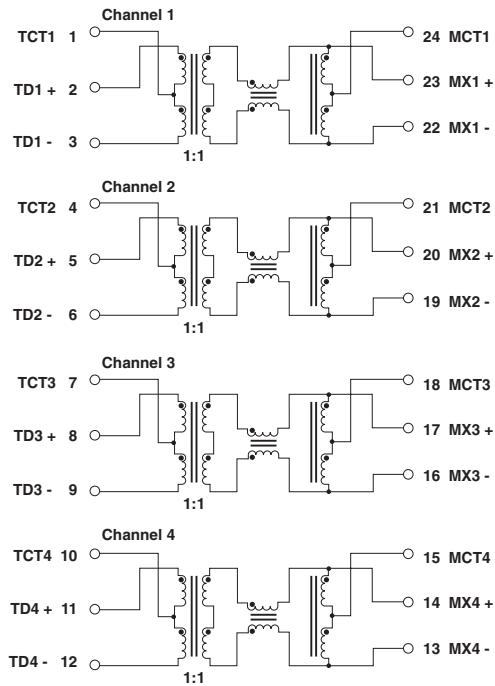

H5014, HX5014

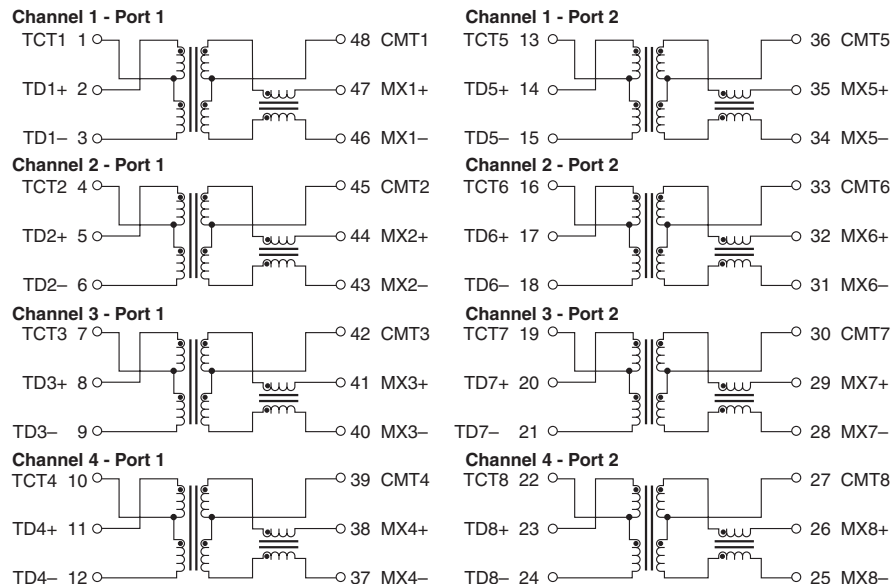

1000BASE-T MAGNETICS MODULES

Designed to Support 1:1
Turns Ratio Transceivers



Schematics (continued)

H5020, HX5020

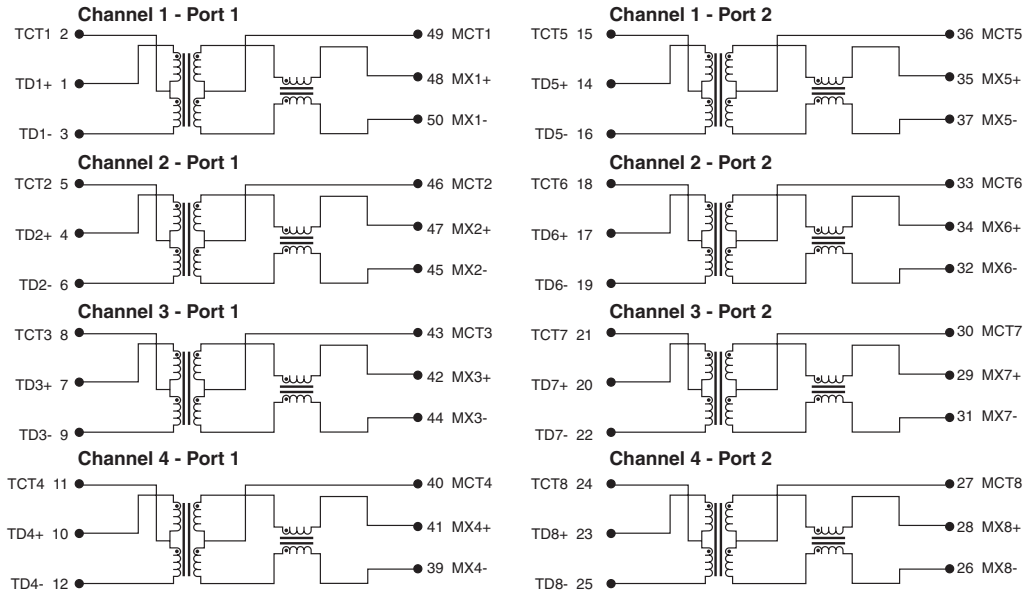

For More Information:

Pulse Worldwide Headquarters

12220 World Trade Dr.
San Diego, CA 92128
U.S.A.

www.pulseeng.com

Tel: 858 674 8100
Fax: 858 674 8262

Pulse Europe

Einsteinstrasse 1
D-71083 Herrenberg
Germany

Tel: 49 7032 7806 0
Fax: 49 7032 7806 135

Pulse China Headquarters

B402, Shenzhen Academy of
Aerospace Technology Bldg.
10th Kejinan Rd.
High-Tech Zone
Nanshan District
Shenzhen, PR China 518057

TEL: 86 755 33966678
FAX: 86 755 33966700

Pulse North China

Room 1503
XinYin Building
No. 888 YiShan Rd.
Shanghai 200233
China

Tel: 86 21 54643211/2
Fax: 86 21 54643210

Pulse South Asia

150 Kampong Ampat
#07-01/02
KA Centre
Singapore 368324

Tel: 65 6287 8998
Fax: 65 6280 0080

Pulse North Asia

No. 26, Kao Ching Rd.
Yang Mei Chen
Taoyuan Hsien
Taiwan
R. O. C.

Tel: 886 3 4643715
Fax: 886 3 4641911

Performance warranty of products offered on this data sheet is limited to the parameters specified. Data is subject to change without notice. Other brand and product names mentioned herein may be trademarks or registered trademarks of their respective owners.

© Copyright, 2008. Pulse Engineering, Inc. All rights reserved.

Looking for pricing, stock, or lifecycle information?

Click below to explore more details on WIN SOURCE:

 [View H5007NL on WIN SOURCE](#)

 [Pulse Information](#)

Optimize Your Supply Chain with WIN SOURCE Solutions

-  Global Sourcing Solution
-  Obsolete Management
-  Cost Control Management
-  Shortage Management
-  Alternative Solution
-  Excess Inventory Management