

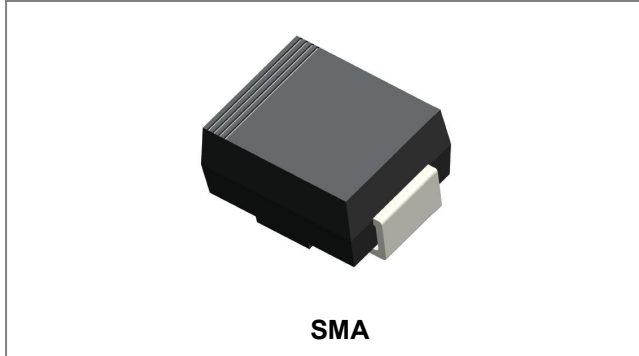

THE DATASHEET OF ES1J



ES1A-ES1M SURFACE MOUNT SUPER FAST RECTIFIER



Features

- Glass Passivated Die Construction
- Ideally Suited for Automatic Assembly
- Low Forward Overload Drop, High Efficiency
- Low Power Loss
- Super-Fast Recovery Time
- Plastic Case Material has UL Flammability Classification Rating 94V-O
- This is a Pb – Free Device
- All SMC parts are traceable to the wafer lot
- Additional testing can be offered upon request

Circuit Diagram



Mechanical Data

- Case: Low Profile Molded Plastic
- Terminals: Solder Plated, Solderable per MIL-STD-750, Method 2026
- Polarity: Cathode Band or Cathode Notch
- Marking: Type Number
- Weight: 0.06 grams(approx)

Maximum Ratings and Electrical Characteristics @ $T_A=25^\circ\text{C}$ unless otherwise specified

Characteristic	Symbol	ES1A	ES1B	ES1C	ES1D	ES1E	ES1G	ES1J	ES1K	ES1M	Units
Peak Repetitive Reverse Voltage	V_{RRM}	50	100	150	200	300	400	600	800	1000	V
RMS Reverse Voltage	$V_{R(RMS)}$	34	70	105	140	210	280	420	560	700	
Average Rectified Output Current @ $T_L=120^\circ\text{C}$	I_o	1.0									A
Peak Forward Surge Current 8.3ms Single half sine-wave superimposed on rated load (JEDEC Method)	I_{FSM}	30									A
Forward voltage @ $I_F=1.0\text{A}$	V_F	0.95			1.3		1.7				V
Peak Reverse Current @ $T_A=25^\circ\text{C}$ At Rated DC Blocking Voltage @ $T_A=100^\circ\text{C}$	I_R						5 50				μA
Typical junction capacitance (Note 1)	C_J	45.0									pF
Reverse Recovery Time (Note 2)	T_{rr}							35		75	ns
Electro-Static Discharge	ESD	2000									V
Typical thermal resistance (Note 3)	$R_{\theta JL}$						35				K/W
Operating Junction and Storage Temperature Range	T_J, T_{STG}	-55 to +150									$^\circ\text{C}$

Note: 1. Measured at 1.0 MHz and applied reverse voltage of 4.0 V_{DC}
 2. Measured with $I_F=0.5\text{A}$, $I_R=1.0\text{A}$, $t_r=0.25\text{A}$
 3. Mounted on P.C. Board with 8.0mm² lead area

Ratings and Characteristics Curves

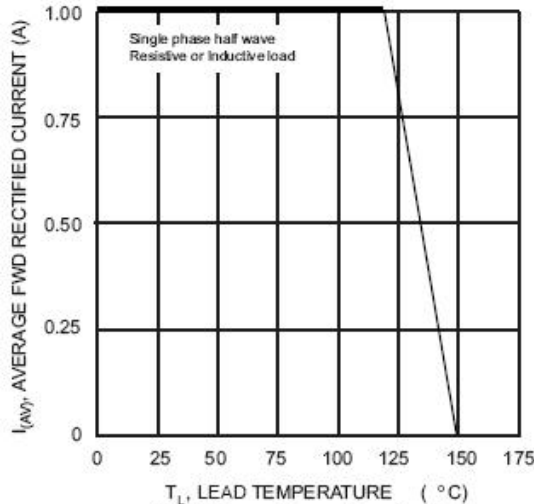

Fig. 1 Forward Current Derating Curve

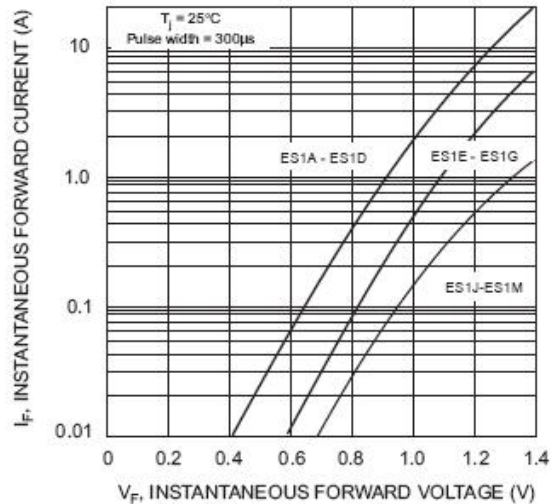

Fig. 2 Typical Forward Characteristics

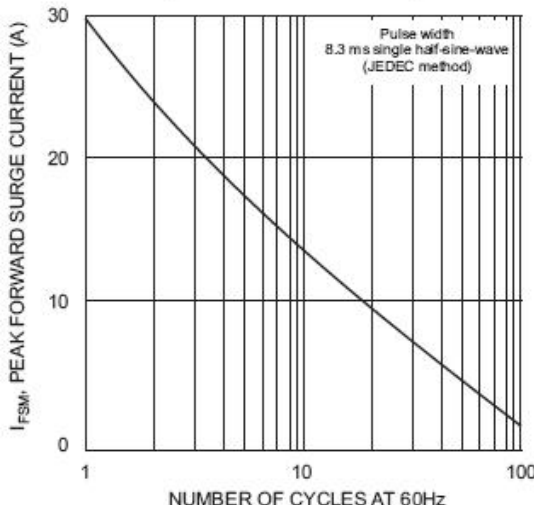

Fig. 3 Peak Forward Surge Current

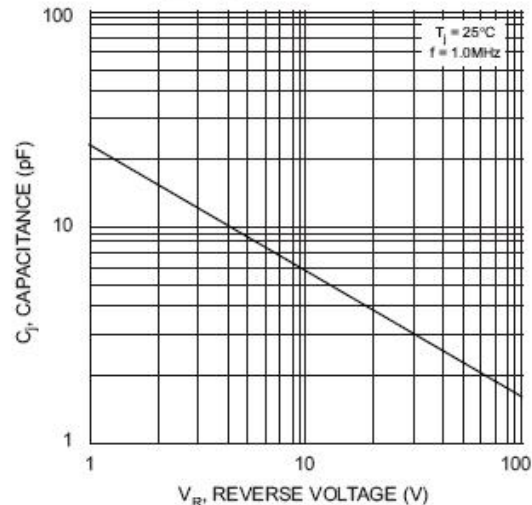
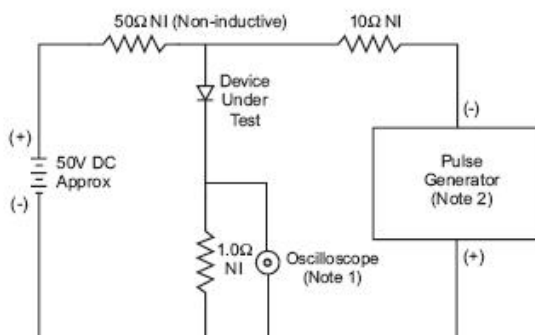

Fig. 4 Typical Junction Capacitance



- Notes:
1. Rise Time = 7.0ns max. Input Impedance = 1.0MΩ, 22pF.
2. Rise Time = 10ns max. Input Impedance = 50Ω.

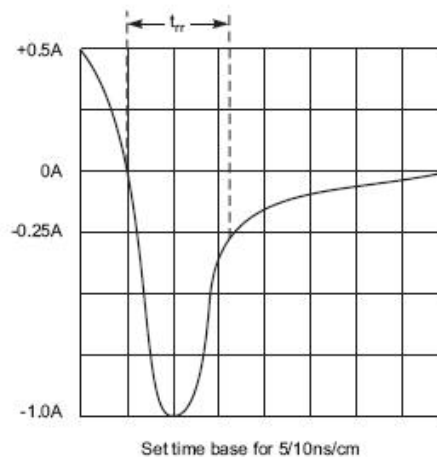
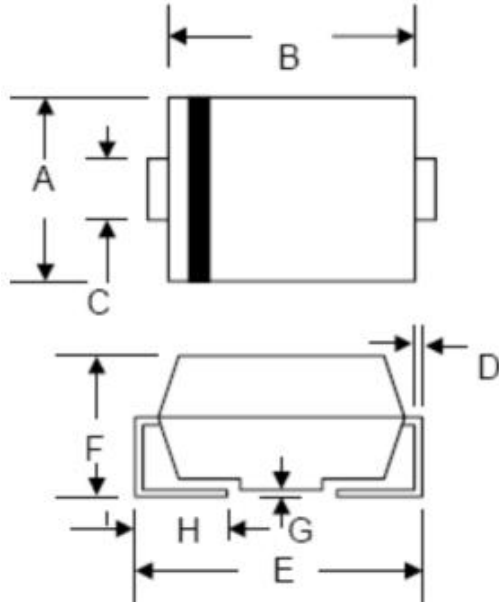

Fig. 5 Reverse Recovery Time Characteristic and Test Circuit

Mechanical Dimensions SMA

SYMBOL	Millimeters		Inches	
	Min.	Max.	Min.	Max.
A	2.40	2.84	0.094	0.112
B	3.99	4.75	0.157	0.187
C	1.05	1.70	0.041	0.067
D	0.15	0.51	0.006	0.020
E	4.80	5.66	0.189	0.223
F	1.90	2.95	0.075	0.116
G	0.05	0.203	0.002	0.008
H	0.76	1.52	0.030	0.600

Ordering Information

Device	Package	Shipping
ES1A-ES1M	SMA (Pb-Free)	5000pcs / reel

For information on tape and reel specifications, including part orientation and tape sizes, please refer to our tape and reel packaging specification.

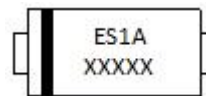
Marking Diagram

Where XXXXX is YYWWL

ES = Device Type
 1 = Forward Current (1A)
 A = Reverse Voltage (50V)
 YY = Year
 WW = Week
 L = Lot Number

Cautions: Molding resin
 Epoxy resin UL:94V-0

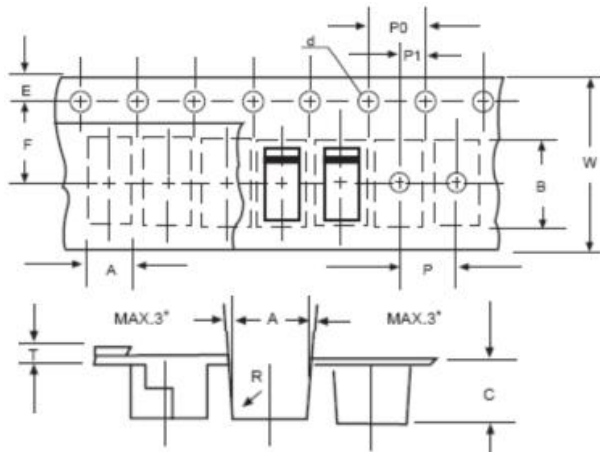
Carrier Tape Specification SMA

SYMBOL	Millimeters	
	Min.	Max.
A	2.97	3.17
B	5.70	5.90
C	2.32	2.52
d	1.40	1.60
E	1.40	1.60
F	5.60	5.70
P	3.90	4.10
P0	3.90	4.10
P1	1.90	2.10
T	0.25	0.35
W	11.80	12.20

DISCLAIMER:

1- The information given herein, including the specifications and dimensions, is subject to change without prior notice to improve product characteristics. Before ordering, purchasers are advised to contact the SMC - Sangdest Microelectronics (Nanjing) Co., Ltd sales department for the latest version of the datasheet(s).

2- In cases where extremely high reliability is required (such as use in nuclear power control, aerospace and aviation, traffic equipment, medical equipment, and safety equipment), safety should be ensured by using semiconductor devices that feature assured safety or by means of users' fail-safe precautions or other arrangement.

3- In no event shall SMC - Sangdest Microelectronics (Nanjing) Co., Ltd be liable for any damages that may result from an accident or any other cause during operation of the user's units according to the datasheet(s). SMC - Sangdest Microelectronics (Nanjing) Co., Ltd assumes no responsibility for any intellectual property claims or any other problems that may result from applications of information, products or circuits described in the datasheets.

4- In no event shall SMC - Sangdest Microelectronics (Nanjing) Co., Ltd be liable for any failure in a semiconductor device or any secondary damage resulting from use at a value exceeding the absolute maximum rating.



5- No license is granted by the datasheet(s) under any patents or other rights of any third party or SMC - Sangdest Microelectronics (Nanjing) Co., Ltd.

6- The datasheet(s) may not be reproduced or duplicated, in any form, in whole or part, without the expressed written permission of SMC - Sangdest Microelectronics (Nanjing) Co., Ltd.

7- The products (technologies) described in the datasheet(s) are not to be provided to any party whose purpose in their application will hinder maintenance of international peace and safety nor are they to be applied to that purpose by their direct purchasers or any third party. When exporting these products (technologies), the necessary procedures are to be taken in accordance with related laws and regulations..

Looking for pricing, stock, or lifecycle information?

Click below to explore more details on WIN SOURCE:

-  [View ES1J on WIN SOURCE](#)
-  [SMC Diode Solutions](#) Information

Optimize Your Supply Chain with WIN SOURCE Solutions

-  Global Sourcing Solution
-  Obsolete Management
-  Cost Control Management
-  Shortage Management
-  Alternative Solution
-  Excess Inventory Management