



**THE DATASHEET OF
LQW15AN1N7C80D**



CHIP COILS (CHIP INDUCTORS) LQW15AN□□□□80□ REFERENCE SPECIFICATION

1. Scope

This reference specification applies to chip coils (chip inductors) LQW15AN_80 series for general electronic equipment.

2. Part Numbering

(Ex.)

LQ	W	15	A	N	1N3	C	8	0	D
Product ID	Structure	Dimension (L × W)	Application and characteristic	Category	Inductance	Tolerance	Performance	Electrode specification	Packaging D: taping *B: bulk

*B: Bulk packing is also available (taping condition: however, products without reels are put in plastic bags).

3. Part Number and Rating

Operating temperature range	-55°C to +125°C
Storage temperature range	-55°C to +125°C

Customer Part number	Murata Part number	Inductance		Q (Min.)	DC resistance (Ω max.)	Self-resonant frequency (GHz min.)	Rated current (mA) ^{*1}
		Nominal value (nH)	Tolerance				
	LQW15AN1N3C80D	1.3	C: ±0.2 nH	20	0.012	18.0	3150
	LQW15AN1N3D80D	1.3	D: ±0.5 nH	20	0.012	18.0	3150
	LQW15AN1N5C80D	1.5	C: ±0.2 nH	20	0.028	18.0	2100
	LQW15AN1N5D80D	1.5	D: ±0.5 nH	20	0.028	18.0	2100
	LQW15AN1N6C80D	1.6	C: ±0.2 nH	20	0.045	18.0	1450
	LQW15AN1N6D80D	1.6	D: ±0.5 nH	20	0.045	18.0	1450
	LQW15AN1N7C80D	1.7	C: ±0.2 nH	20	0.065	18.0	1150
	LQW15AN1N7D80D	1.7	D: ±0.5 nH	20	0.065	18.0	1150
	LQW15AN2N2B80D	2.2	B: ±0.1 nH	30	0.022	15.5	2530
	LQW15AN2N2C80D	2.2	C: ±0.2 nH	30	0.022	15.5	2530
	LQW15AN2N2D80D	2.2	D: ±0.5 nH	30	0.022	15.5	2530
	LQW15AN2N2G80D	2.2	G: ±2%	30	0.022	15.5	2530
	LQW15AN2N3B80D	2.3	B: ±0.1 nH	30	0.022	15.5	2530
	LQW15AN2N3C80D	2.3	C: ±0.2 nH	30	0.022	15.5	2530
	LQW15AN2N3D80D	2.3	D: ±0.5 nH	30	0.022	15.5	2530
	LQW15AN2N3G80D	2.3	G: ±2%	30	0.022	15.5	2530
	LQW15AN2N4B80D	2.4	B: ±0.1 nH	30	0.022	15.5	2530
	LQW15AN2N4C80D	2.4	C: ±0.2 nH	30	0.022	15.5	2530
	LQW15AN2N4D80D	2.4	D: ±0.5 nH	30	0.022	15.5	2530
	LQW15AN2N4G80D	2.4	G: ±2%	30	0.022	15.5	2530
	LQW15AN2N5B80D	2.5	B: ±0.1 nH	30	0.030	15.5	2100
	LQW15AN2N5C80D	2.5	C: ±0.2 nH	30	0.030	15.5	2100
	LQW15AN2N5D80D	2.5	D: ±0.5 nH	30	0.030	15.5	2100
	LQW15AN2N5G80D	2.5	G: ±2%	30	0.030	15.5	2100
	LQW15AN2N6B80D	2.6	B: ±0.1 nH	30	0.035	14.5	1950
	LQW15AN2N6C80D	2.6	C: ±0.2 nH	30	0.035	14.5	1950
	LQW15AN2N6D80D	2.6	D: ±0.5 nH	30	0.035	14.5	1950
	LQW15AN2N6G80D	2.6	G: ±2%	30	0.035	14.5	1950
	LQW15AN2N7B80D	2.7	B: ±0.1 nH	28	0.047	14.0	1500
	LQW15AN2N7C80D	2.7	C: ±0.2 nH	28	0.047	14.0	1500
	LQW15AN2N7D80D	2.7	D: ±0.5 nH	28	0.047	14.0	1500

Customer Part number	Murata Part number	Inductance		Q (Min.)	DC resistance (Ω max.)	Self-resonant frequency (GHz min.)	Rated current (mA) ^{*1}
		Nominal value (nH)	Tolerance				
	LQW15AN2N7G80D	2.7	G: $\pm 2\%$	28	0.047	14.0	1500
	LQW15AN2N8B80D	2.8	B: ± 0.1 nH	27	0.047	13.5	1500
	LQW15AN2N8C80D	2.8	C: ± 0.2 nH	27	0.047	13.5	1500
	LQW15AN2N8D80D	2.8	D: ± 0.5 nH	27	0.047	13.5	1500
	LQW15AN2N8G80D	2.8	G: $\pm 2\%$	27	0.047	13.5	1500
	LQW15AN2N9B80D	2.9	B: ± 0.1 nH	25	0.047	12.5	1500
	LQW15AN2N9C80D	2.9	C: ± 0.2 nH	25	0.047	12.5	1500
	LQW15AN2N9D80D	2.9	D: ± 0.5 nH	25	0.047	12.5	1500
	LQW15AN2N9G80D	2.9	G: $\pm 2\%$	25	0.047	12.5	1500
	LQW15AN3N0B80D	3.0	B: ± 0.1 nH	20	0.063	12.5	1350
	LQW15AN3N0C80D	3.0	C: ± 0.2 nH	20	0.063	12.5	1350
	LQW15AN3N0D80D	3.0	D: ± 0.5 nH	20	0.063	12.5	1350
	LQW15AN3N0G80D	3.0	G: $\pm 2\%$	20	0.063	12.5	1350
	LQW15AN3N3B80D	3.3	B: ± 0.1 nH	30	0.030	14.0	2000
	LQW15AN3N3C80D	3.3	C: ± 0.2 nH	30	0.030	14.0	2000
	LQW15AN3N3D80D	3.3	D: ± 0.5 nH	30	0.030	14.0	2000
	LQW15AN3N3G80D	3.3	G: $\pm 2\%$	30	0.030	14.0	2000
	LQW15AN3N4B80D	3.4	B: ± 0.1 nH	30	0.030	10.0	1950
	LQW15AN3N4C80D	3.4	C: ± 0.2 nH	30	0.030	10.0	1950
	LQW15AN3N4D80D	3.4	D: ± 0.5 nH	30	0.030	10.0	1950
	LQW15AN3N4G80D	3.4	G: $\pm 2\%$	30	0.030	10.0	1950
	LQW15AN3N5B80D	3.5	B: ± 0.1 nH	30	0.030	10.0	1950
	LQW15AN3N5C80D	3.5	C: ± 0.2 nH	30	0.030	10.0	1950
	LQW15AN3N5D80D	3.5	D: ± 0.5 nH	30	0.030	10.0	1950
	LQW15AN3N5G80D	3.5	G: $\pm 2\%$	30	0.030	10.0	1950
	LQW15AN3N6B80D	3.6	B: ± 0.1 nH	30	0.030	10.0	1950
	LQW15AN3N6C80D	3.6	C: ± 0.2 nH	30	0.030	10.0	1950
	LQW15AN3N6D80D	3.6	D: ± 0.5 nH	30	0.030	10.0	1950
	LQW15AN3N6G80D	3.6	G: $\pm 2\%$	30	0.030	10.0	1950
	LQW15AN3N7B80D	3.7	B: ± 0.1 nH	35	0.030	10.0	1950
	LQW15AN3N7C80D	3.7	C: ± 0.2 nH	35	0.030	10.0	1950
	LQW15AN3N7D80D	3.7	D: ± 0.5 nH	35	0.030	10.0	1950
	LQW15AN3N7G80D	3.7	G: $\pm 2\%$	35	0.030	10.0	1950
	LQW15AN3N8B80D	3.8	B: ± 0.1 nH	35	0.030	10.0	1950
	LQW15AN3N8C80D	3.8	C: ± 0.2 nH	35	0.030	10.0	1950
	LQW15AN3N8D80D	3.8	D: ± 0.5 nH	35	0.030	10.0	1950
	LQW15AN3N8G80D	3.8	G: $\pm 2\%$	35	0.030	10.0	1950
	LQW15AN3N9B80D	3.9	B: ± 0.1 nH	35	0.030	10.0	1950
	LQW15AN3N9C80D	3.9	C: ± 0.2 nH	35	0.030	10.0	1950
	LQW15AN3N9D80D	3.9	D: ± 0.5 nH	35	0.030	10.0	1950
	LQW15AN3N9G80D	3.9	G: $\pm 2\%$	35	0.030	10.0	1950
	LQW15AN4N0B80D	4.0	B: ± 0.1 nH	30	0.030	10.0	1950
	LQW15AN4N0C80D	4.0	C: ± 0.2 nH	30	0.030	10.0	1950
	LQW15AN4N0D80D	4.0	D: ± 0.5 nH	30	0.030	10.0	1950
	LQW15AN4N0G80D	4.0	G: $\pm 2\%$	30	0.030	10.0	1950
	LQW15AN4N1B80D	4.1	B: ± 0.1 nH	30	0.044	9.6	1800

Customer Part number	Murata Part number	Inductance		Q (Min.)	DC resistance (Ω max.)	Self-resonant frequency (GHz min.)	Rated current (mA) ^{*1}
		Nominal value (nH)	Tolerance				
	LQW15AN4N1C80D	4.1	C: ± 0.2 nH	30	0.044	9.6	1800
	LQW15AN4N1D80D	4.1	D: ± 0.5 nH	30	0.044	9.6	1800
	LQW15AN4N1G80D	4.1	G: $\pm 2\%$	30	0.044	9.6	1800
	LQW15AN4N2B80D	4.2	B: ± 0.1 nH	30	0.044	9.6	1800
	LQW15AN4N2C80D	4.2	C: ± 0.2 nH	30	0.044	9.6	1800
	LQW15AN4N2D80D	4.2	D: ± 0.5 nH	30	0.044	9.6	1800
	LQW15AN4N2G80D	4.2	G: $\pm 2\%$	30	0.044	9.6	1800
	LQW15AN4N3B80D	4.3	B: ± 0.1 nH	32	0.044	9.6	1800
	LQW15AN4N3C80D	4.3	C: ± 0.2 nH	32	0.044	9.6	1800
	LQW15AN4N3D80D	4.3	D: ± 0.5 nH	32	0.044	9.6	1800
	LQW15AN4N3G80D	4.3	G: $\pm 2\%$	32	0.044	9.6	1800
	LQW15AN4N4B80D	4.4	B: ± 0.1 nH	34	0.052	9.6	1600
	LQW15AN4N4C80D	4.4	C: ± 0.2 nH	34	0.052	9.6	1600
	LQW15AN4N4D80D	4.4	D: ± 0.5 nH	34	0.052	9.6	1600
	LQW15AN4N4G80D	4.4	G: $\pm 2\%$	34	0.052	9.6	1600
	LQW15AN4N5B80D	4.5	B: ± 0.1 nH	34	0.060	9.6	1450
	LQW15AN4N5C80D	4.5	C: ± 0.2 nH	34	0.060	9.6	1450
	LQW15AN4N5D80D	4.5	D: ± 0.5 nH	34	0.060	9.6	1450
	LQW15AN4N5G80D	4.5	G: $\pm 2\%$	34	0.060	9.6	1450
	LQW15AN4N6B80D	4.6	B: ± 0.1 nH	32	0.060	9.6	1450
	LQW15AN4N6C80D	4.6	C: ± 0.2 nH	32	0.060	9.6	1450
	LQW15AN4N6D80D	4.6	D: ± 0.5 nH	32	0.060	9.6	1450
	LQW15AN4N6G80D	4.6	G: $\pm 2\%$	32	0.060	9.6	1450
	LQW15AN4N7B80D	4.7	B: ± 0.1 nH	31	0.071	8.0	1200
	LQW15AN4N7C80D	4.7	C: ± 0.2 nH	31	0.071	8.0	1200
	LQW15AN4N7D80D	4.7	D: ± 0.5 nH	31	0.071	8.0	1200
	LQW15AN4N7G80D	4.7	G: $\pm 2\%$	31	0.071	8.0	1200
	LQW15AN4N8B80D	4.8	B: ± 0.1 nH	30	0.071	8.0	1200
	LQW15AN4N8C80D	4.8	C: ± 0.2 nH	30	0.071	8.0	1200
	LQW15AN4N8D80D	4.8	D: ± 0.5 nH	30	0.071	8.0	1200
	LQW15AN4N8G80D	4.8	G: $\pm 2\%$	30	0.071	8.0	1200
	LQW15AN4N9B80D	4.9	B: ± 0.1 nH	27	0.071	8.0	1200
	LQW15AN4N9C80D	4.9	C: ± 0.2 nH	27	0.071	8.0	1200
	LQW15AN4N9D80D	4.9	D: ± 0.5 nH	27	0.071	8.0	1200
	LQW15AN4N9G80D	4.9	G: $\pm 2\%$	27	0.071	8.0	1200
	LQW15AN5N0B80D	5.0	B: ± 0.1 nH	32	0.040	10.0	1770
	LQW15AN5N0C80D	5.0	C: ± 0.2 nH	32	0.040	10.0	1770
	LQW15AN5N0D80D	5.0	D: ± 0.5 nH	32	0.040	10.0	1770
	LQW15AN5N0G80D	5.0	G: $\pm 2\%$	32	0.040	10.0	1770
	LQW15AN5N1B80D	5.1	B: ± 0.1 nH	35	0.040	8.0	1770
	LQW15AN5N1C80D	5.1	C: ± 0.2 nH	35	0.040	8.0	1770
	LQW15AN5N1D80D	5.1	D: ± 0.5 nH	35	0.040	8.0	1770
	LQW15AN5N1G80D	5.1	G: $\pm 2\%$	35	0.040	8.0	1770
	LQW15AN5N2B80D	5.2	B: ± 0.1 nH	35	0.040	8.0	1770
	LQW15AN5N2C80D	5.2	C: ± 0.2 nH	35	0.040	8.0	1770
	LQW15AN5N2D80D	5.2	D: ± 0.5 nH	35	0.040	8.0	1770

Customer Part number	Murata Part number	Inductance		Q (Min.)	DC resistance (Ω max.)	Self-resonant frequency (GHz min.)	Rated current (mA) ^{*1}
		Nominal value (nH)	Tolerance				
	LQW15AN5N2G80D	5.2	G: $\pm 2\%$	35	0.040	8.0	1770
	LQW15AN5N3B80D	5.3	B: ± 0.1 nH	35	0.040	8.0	1770
	LQW15AN5N3C80D	5.3	C: ± 0.2 nH	35	0.040	8.0	1770
	LQW15AN5N3D80D	5.3	D: ± 0.5 nH	35	0.040	8.0	1770
	LQW15AN5N3G80D	5.3	G: $\pm 2\%$	35	0.040	8.0	1770
	LQW15AN5N4B80D	5.4	B: ± 0.1 nH	35	0.040	8.0	1770
	LQW15AN5N4C80D	5.4	C: ± 0.2 nH	35	0.040	8.0	1770
	LQW15AN5N4D80D	5.4	D: ± 0.5 nH	35	0.040	8.0	1770
	LQW15AN5N4G80D	5.4	G: $\pm 2\%$	35	0.040	8.0	1770
	LQW15AN5N5B80D	5.5	B: ± 0.1 nH	35	0.040	8.0	1770
	LQW15AN5N5C80D	5.5	C: ± 0.2 nH	35	0.040	8.0	1770
	LQW15AN5N5D80D	5.5	D: ± 0.5 nH	35	0.040	8.0	1770
	LQW15AN5N5G80D	5.5	G: $\pm 2\%$	35	0.040	8.0	1770
	LQW15AN5N6B80D	5.6	B: ± 0.1 nH	35	0.040	8.0	1770
	LQW15AN5N6C80D	5.6	C: ± 0.2 nH	35	0.040	8.0	1770
	LQW15AN5N6D80D	5.6	D: ± 0.5 nH	35	0.040	8.0	1770
	LQW15AN5N6G80D	5.6	G: $\pm 2\%$	35	0.040	8.0	1770
	LQW15AN5N7B80D	5.7	B: ± 0.1 nH	30	0.040	8.0	1770
	LQW15AN5N7C80D	5.7	C: ± 0.2 nH	30	0.040	8.0	1770
	LQW15AN5N7D80D	5.7	D: ± 0.5 nH	30	0.040	8.0	1770
	LQW15AN5N7G80D	5.7	G: $\pm 2\%$	30	0.040	8.0	1770
	LQW15AN5N8B80D	5.8	B: ± 0.1 nH	30	0.040	8.0	1770
	LQW15AN5N8C80D	5.8	C: ± 0.2 nH	30	0.040	8.0	1770
	LQW15AN5N8D80D	5.8	D: ± 0.5 nH	30	0.040	8.0	1770
	LQW15AN5N8G80D	5.8	G: $\pm 2\%$	30	0.040	8.0	1770
	LQW15AN5N9B80D	5.9	B: ± 0.1 nH	30	0.040	8.0	1770
	LQW15AN5N9C80D	5.9	C: ± 0.2 nH	30	0.040	8.0	1770
	LQW15AN5N9D80D	5.9	D: ± 0.5 nH	30	0.040	8.0	1770
	LQW15AN5N9G80D	5.9	G: $\pm 2\%$	30	0.040	8.0	1770
	LQW15AN6N0B80D	6.0	B: ± 0.1 nH	32	0.056	8.0	1600
	LQW15AN6N0C80D	6.0	C: ± 0.2 nH	32	0.056	8.0	1600
	LQW15AN6N0D80D	6.0	D: ± 0.5 nH	32	0.056	8.0	1600
	LQW15AN6N0G80D	6.0	G: $\pm 2\%$	32	0.056	8.0	1600
	LQW15AN6N1B80D	6.1	B: ± 0.1 nH	32	0.056	8.0	1600
	LQW15AN6N1C80D	6.1	C: ± 0.2 nH	32	0.056	8.0	1600
	LQW15AN6N1D80D	6.1	D: ± 0.5 nH	32	0.056	8.0	1600
	LQW15AN6N1G80D	6.1	G: $\pm 2\%$	32	0.056	8.0	1600
	LQW15AN6N2B80D	6.2	B: ± 0.1 nH	33	0.056	8.0	1600
	LQW15AN6N2C80D	6.2	C: ± 0.2 nH	33	0.056	8.0	1600
	LQW15AN6N2D80D	6.2	D: ± 0.5 nH	33	0.056	8.0	1600
	LQW15AN6N2G80D	6.2	G: $\pm 2\%$	33	0.056	8.0	1600
	LQW15AN6N3G80D	6.3	G: $\pm 2\%$	32	0.057	7.8	1600
	LQW15AN6N3J80D	6.3	J: $\pm 5\%$	32	0.057	7.8	1600
	LQW15AN6N4G80D	6.4	G: $\pm 2\%$	33	0.065	7.0	1380
	LQW15AN6N4J80D	6.4	J: $\pm 5\%$	33	0.065	7.0	1380
	LQW15AN6N5G80D	6.5	G: $\pm 2\%$	32	0.065	7.0	1380

Customer Part number	Murata Part number	Inductance		Q (Min.)	DC resistance (Ω max.)	Self-resonant frequency (GHz min.)	Rated current (mA) ^{*1}
		Nominal value (nH)	Tolerance				
	LQW15AN6N5J80D	6.5	J: $\pm 5\%$	32	0.065	7.0	1380
	LQW15AN6N6G80D	6.6	G: $\pm 2\%$	30	0.078	7.0	1280
	LQW15AN6N6J80D	6.6	J: $\pm 5\%$	30	0.078	7.0	1280
	LQW15AN6N7G80D	6.7	G: $\pm 2\%$	30	0.078	7.0	1280
	LQW15AN6N7J80D	6.7	J: $\pm 5\%$	30	0.078	7.0	1280
	LQW15AN6N8G80D	6.8	G: $\pm 2\%$	30	0.068	7.0	1450
	LQW15AN6N8J80D	6.8	J: $\pm 5\%$	30	0.068	7.0	1450
	LQW15AN6N9G80D	6.9	G: $\pm 2\%$	32	0.069	8.5	1420
	LQW15AN6N9J80D	6.9	J: $\pm 5\%$	32	0.069	8.5	1420
	LQW15AN7N0G80D	7.0	G: $\pm 2\%$	33	0.069	8.0	1420
	LQW15AN7N0J80D	7.0	J: $\pm 5\%$	33	0.069	8.0	1420
	LQW15AN7N1G80D	7.1	G: $\pm 2\%$	32	0.069	7.0	1420
	LQW15AN7N1J80D	7.1	J: $\pm 5\%$	32	0.069	7.0	1420
	LQW15AN7N2G80D	7.2	G: $\pm 2\%$	32	0.050	7.0	1700
	LQW15AN7N2J80D	7.2	J: $\pm 5\%$	32	0.050	7.0	1700
	LQW15AN7N3G80D	7.3	G: $\pm 2\%$	32	0.050	7.0	1700
	LQW15AN7N3J80D	7.3	J: $\pm 5\%$	32	0.050	7.0	1700
	LQW15AN7N4G80D	7.4	G: $\pm 2\%$	30	0.050	7.0	1700
	LQW15AN7N4J80D	7.4	J: $\pm 5\%$	30	0.050	7.0	1700
	LQW15AN7N5G80D	7.5	G: $\pm 2\%$	35	0.050	7.0	1700
	LQW15AN7N5J80D	7.5	J: $\pm 5\%$	35	0.050	7.0	1700
	LQW15AN7N6G80D	7.6	G: $\pm 2\%$	30	0.050	7.0	1700
	LQW15AN7N6J80D	7.6	J: $\pm 5\%$	30	0.050	7.0	1700
	LQW15AN7N7G80D	7.7	G: $\pm 2\%$	30	0.050	7.0	1700
	LQW15AN7N7J80D	7.7	J: $\pm 5\%$	30	0.050	7.0	1700
	LQW15AN7N8G80D	7.8	G: $\pm 2\%$	30	0.050	7.0	1700
	LQW15AN7N8J80D	7.8	J: $\pm 5\%$	30	0.050	7.0	1700
	LQW15AN7N9G80D	7.9	G: $\pm 2\%$	30	0.050	7.0	1700
	LQW15AN7N9J80D	7.9	J: $\pm 5\%$	30	0.050	7.0	1700
	LQW15AN8N0G80D	8.0	G: $\pm 2\%$	30	0.050	7.0	1700
	LQW15AN8N0J80D	8.0	J: $\pm 5\%$	30	0.050	7.0	1700
	LQW15AN8N1G80D	8.1	G: $\pm 2\%$	32	0.069	6.5	1500
	LQW15AN8N1J80D	8.1	J: $\pm 5\%$	32	0.069	6.5	1500
	LQW15AN8N2G80D	8.2	G: $\pm 2\%$	32	0.069	6.5	1500
	LQW15AN8N2J80D	8.2	J: $\pm 5\%$	32	0.069	6.5	1500
	LQW15AN8N3G80D	8.3	G: $\pm 2\%$	32	0.069	6.5	1500
	LQW15AN8N3J80D	8.3	J: $\pm 5\%$	32	0.069	6.5	1500
	LQW15AN8N4G80D	8.4	G: $\pm 2\%$	32	0.069	6.5	1500
	LQW15AN8N4J80D	8.4	J: $\pm 5\%$	32	0.069	6.5	1500
	LQW15AN8N5G80D	8.5	G: $\pm 2\%$	32	0.069	6.5	1500
	LQW15AN8N5J80D	8.5	J: $\pm 5\%$	32	0.069	6.5	1500
	LQW15AN8N6G80D	8.6	G: $\pm 2\%$	31	0.070	6.5	1420
	LQW15AN8N6J80D	8.6	J: $\pm 5\%$	31	0.070	6.5	1420
	LQW15AN8N7G80D	8.7	G: $\pm 2\%$	31	0.070	6.5	1420
	LQW15AN8N7J80D	8.7	J: $\pm 5\%$	31	0.070	6.5	1420
	LQW15AN8N8G80D	8.8	G: $\pm 2\%$	31	0.070	6.5	1420

Customer Part number	Murata Part number	Inductance		Q (Min.)	DC resistance (Ω max.)	Self-resonant frequency (GHz min.)	Rated current (mA) ^{*1}
		Nominal value (nH)	Tolerance				
	LQW15AN8N8J80D	8.8	J: $\pm 5\%$	31	0.070	6.5	1420
	LQW15AN8N9G80D	8.9	G: $\pm 2\%$	31	0.070	6.5	1420
	LQW15AN8N9J80D	8.9	J: $\pm 5\%$	31	0.070	6.5	1420
	LQW15AN9N0G80D	9.0	G: $\pm 2\%$	30	0.070	6.5	1420
	LQW15AN9N0J80D	9.0	J: $\pm 5\%$	30	0.070	6.5	1420
	LQW15AN9N1G80D	9.1	G: $\pm 2\%$	32	0.080	6.5	1400
	LQW15AN9N1J80D	9.1	J: $\pm 5\%$	32	0.080	6.5	1400
	LQW15AN9N2G80D	9.2	G: $\pm 2\%$	32	0.081	6.0	1400
	LQW15AN9N2J80D	9.2	J: $\pm 5\%$	32	0.081	6.0	1400
	LQW15AN9N3G80D	9.3	G: $\pm 2\%$	34	0.081	6.0	1400
	LQW15AN9N3J80D	9.3	J: $\pm 5\%$	34	0.081	6.0	1400
	LQW15AN9N4G80D	9.4	G: $\pm 2\%$	33	0.081	6.0	1400
	LQW15AN9N4J80D	9.4	J: $\pm 5\%$	33	0.081	6.0	1400
	LQW15AN9N5G80D	9.5	G: $\pm 2\%$	32	0.081	6.0	1400
	LQW15AN9N5J80D	9.5	J: $\pm 5\%$	32	0.081	6.0	1400
	LQW15AN9N6G80D	9.6	G: $\pm 2\%$	33	0.081	6.0	1400
	LQW15AN9N6J80D	9.6	J: $\pm 5\%$	33	0.081	6.0	1400
	LQW15AN9N7G80D	9.7	G: $\pm 2\%$	33	0.081	6.0	1400
	LQW15AN9N7J80D	9.7	J: $\pm 5\%$	33	0.081	6.0	1400
	LQW15AN9N8G80D	9.8	G: $\pm 2\%$	34	0.081	6.0	1400
	LQW15AN9N8J80D	9.8	J: $\pm 5\%$	34	0.081	6.0	1400
	LQW15AN9N9G80D	9.9	G: $\pm 2\%$	32	0.081	6.0	1400
	LQW15AN9N9J80D	9.9	J: $\pm 5\%$	32	0.081	6.0	1400
	LQW15AN10NG80D	10	G: $\pm 2\%$	31	0.081	6.0	1400
	LQW15AN10NJ80D	10	J: $\pm 5\%$	31	0.081	6.0	1400
	LQW15AN11NG80D	11	G: $\pm 2\%$	32	0.083	6.2	1400
	LQW15AN11NJ80D	11	J: $\pm 5\%$	32	0.083	6.2	1400
	LQW15AN12NG80D	12	G: $\pm 2\%$	30	0.093	5.2	1240
	LQW15AN12NJ80D	12	J: $\pm 5\%$	30	0.093	5.2	1240
	LQW15AN13NG80D	13	G: $\pm 2\%$	30	0.093	5.2	1240
	LQW15AN13NJ80D	13	J: $\pm 5\%$	30	0.093	5.2	1240
	LQW15AN14NG80D	14	G: $\pm 2\%$	31	0.111	5.2	1150
	LQW15AN14NJ80D	14	J: $\pm 5\%$	31	0.111	5.2	1150
	LQW15AN15NG80D	15	G: $\pm 2\%$	31	0.114	5.5	1150
	LQW15AN15NJ80D	15	J: $\pm 5\%$	31	0.114	5.5	1150
	LQW15AN16NG80D	16	G: $\pm 2\%$	31	0.126	5.0	1000
	LQW15AN16NJ80D	16	J: $\pm 5\%$	31	0.126	5.0	1000
	LQW15AN17NG80D	17	G: $\pm 2\%$	30	0.126	5.0	1000
	LQW15AN17NJ80D	17	J: $\pm 5\%$	30	0.126	5.0	1000
	LQW15AN18NG80D	18	G: $\pm 2\%$	30	0.130	5.2	1050
	LQW15AN18NJ80D	18	J: $\pm 5\%$	30	0.130	5.2	1050
	LQW15AN19NG80D	19	G: $\pm 2\%$	30	0.156	5.0	920
	LQW15AN19NJ80D	19	J: $\pm 5\%$	30	0.156	5.0	920
	LQW15AN20NG80D	20	G: $\pm 2\%$	30	0.186	4.5	800
	LQW15AN20NJ80D	20	J: $\pm 5\%$	30	0.186	4.5	800
	LQW15AN21NG80D	21	G: $\pm 2\%$	30	0.202	4.5	780

Customer Part number	Murata Part number	Inductance		Q (Min.)	DC resistance (Ω max.)	Self-resonant frequency (GHz min.)	Rated current (mA) ^{*1}
		Nominal value (nH)	Tolerance				
	LQW15AN21NJ80D	21	J: $\pm 5\%$	30	0.202	4.5	780
	LQW15AN22NG80D	22	G: $\pm 2\%$	30	0.202	4.5	780
	LQW15AN22NJ80D	22	J: $\pm 5\%$	30	0.202	4.5	780
	LQW15AN23NG80D	23	G: $\pm 2\%$	29	0.201	4.5	760
	LQW15AN23NJ80D	23	J: $\pm 5\%$	29	0.201	4.5	760
	LQW15AN24NG80D	24	G: $\pm 2\%$	31	0.212	4.0	770
	LQW15AN24NJ80D	24	J: $\pm 5\%$	31	0.212	4.0	770
	LQW15AN25NG80D	25	G: $\pm 2\%$	31	0.221	4.1	750
	LQW15AN25NJ80D	25	J: $\pm 5\%$	31	0.221	4.1	750
	LQW15AN26NG80D	26	G: $\pm 2\%$	29	0.282	4.1	720
	LQW15AN26NJ80D	26	J: $\pm 5\%$	29	0.282	4.1	720
	LQW15AN27NG80D	27	G: $\pm 2\%$	30	0.288	4.0	680
	LQW15AN27NJ80D	27	J: $\pm 5\%$	30	0.288	4.0	680
	LQW15AN30NG80D	30	G: $\pm 2\%$	30	0.309	3.8	660
	LQW15AN30NJ80D	30	J: $\pm 5\%$	30	0.309	3.8	660
	LQW15AN33NG80D	33	G: $\pm 2\%$	30	0.336	3.6	620
	LQW15AN33NJ80D	33	J: $\pm 5\%$	30	0.336	3.6	620
	LQW15AN36NG80D	36	G: $\pm 2\%$	30	0.431	3.5	540
	LQW15AN36NJ80D	36	J: $\pm 5\%$	30	0.431	3.5	540
	LQW15AN39NG80D	39	G: $\pm 2\%$	28	0.456	3.4	530
	LQW15AN39NJ80D	39	J: $\pm 5\%$	28	0.456	3.4	530
	LQW15AN43NG80D	43	G: $\pm 2\%$	30	0.516	3.4	515
	LQW15AN43NJ80D	43	J: $\pm 5\%$	30	0.516	3.4	515
	LQW15AN47NG80D	47	G: $\pm 2\%$	25	0.648	3.2	440
	LQW15AN47NJ80D	47	J: $\pm 5\%$	25	0.648	3.2	440
	LQW15AN51NG80D	51	G: $\pm 2\%$	25	0.696	2.9	415
	LQW15AN51NJ80D	51	J: $\pm 5\%$	25	0.696	2.9	415
	LQW15AN53NG80D	53	G: $\pm 2\%$	25	0.696	2.9	415
	LQW15AN53NJ80D	53	J: $\pm 5\%$	25	0.696	2.9	415
	LQW15AN56NG80D	56	G: $\pm 2\%$	25	0.996	2.9	340
	LQW15AN56NJ80D	56	J: $\pm 5\%$	25	0.996	2.9	340
	LQW15AN68NG80D	68	G: $\pm 2\%$	25	1.128	2.5	320
	LQW15AN68NJ80D	68	J: $\pm 5\%$	25	1.128	2.5	320
	LQW15AN75NG80D	75	G: $\pm 2\%$	25	1.224	2.4	320
	LQW15AN75NJ80D	75	J: $\pm 5\%$	25	1.224	2.4	320

*1 As shown in the diagram below, derating is applied to the rated current based on the operating temperature.



4. Testing Conditions

Unless otherwise specified	Temperature: ordinary temperature (15°C to 35°C) Humidity: ordinary humidity [25% to 85% (RH)]
In case of doubt	Temperature: 20°C±2°C Humidity: 60% to 70% (RH) Atmospheric pressure: 86 kPa to 106 kPa

5. Appearance and Dimensions



Unit mass (typical value): 0.0009 g

6. Marking

No marking.

7. Electrical Performance

No.	Item	Specification	Test method								
7.1	Inductance	Meet chapter 3 ratings.	Measuring equipment: Keysight E4991A or the equivalent Measuring frequency: <table border="1"> <tr> <td>Inductance</td> <td colspan="2">100 MHz</td> </tr> <tr> <td rowspan="2">Q</td> <td>250 MHz</td> <td>1.3 nH to 43 nH</td> </tr> <tr> <td>200 MHz</td> <td>47 nH to 75 nH</td> </tr> </table> Measuring conditions: Measurement signal level: Approx. 0 dBm Measurement terminal distance: 0.5 mm Electrical length: 10.0 mm Weight: Approx. 1 N to 3 N Measuring fixture: Keysight 16197A Position the chip coil under test as shown in the measuring example below and connect it to the electrode by applying weight. Measurement example:	Inductance	100 MHz		Q	250 MHz	1.3 nH to 43 nH	200 MHz	47 nH to 75 nH
Inductance	100 MHz										
Q	250 MHz	1.3 nH to 43 nH									
	200 MHz	47 nH to 75 nH									
7.2	Q	Meet chapter 3 ratings.	 <p>The diagram illustrates the measurement setup. On the left, a circular 'Guide' has four small circles representing contact points. An arrow points from a small rectangular component towards the center of the guide. On the right, a larger rectangular 'Product' is shown with a shaded area, representing the component being tested within the guide.</p> Measuring method: see "Electrical performance: Measuring method for inductance/Q" in the chapter "16. Appendix".								
7.3	DC resistance	Meet chapter 3 ratings.	Measuring equipment: digital multimeter								
7.4	Self-resonant frequency	Meet chapter 3 ratings.	Measuring equipment: Keysight N5230 or the equivalent								
7.5	Rated current	Product temperature rise: 40°C max.	Apply the rated current specified in chapter 3.								

8. Mechanical Performance

No.	Item	Specification	Test method
8.1	Shear test	No significant mechanical damage or no sign of electrode peeling off shall be observed.	Test substrate: glass-epoxy substrate Force application direction:  <p>The diagram shows a 3D perspective of a rectangular block placed on a flat rectangular substrate. An arrow points to the right, indicating the direction of force application to the block.</p> Applying force: 5 N Holding time: 5 ±1 s

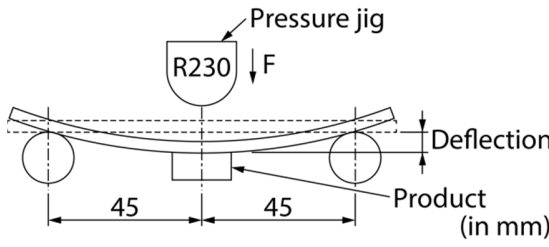
No.	Item	Specification	Test method
8.2	Bending test	No significant mechanical damage or no sign of electrode peeling off shall be observed.	<p>Test substrate: glass-epoxy substrate (100 mm × 40 mm × 0.8 mm) Pressurizing speed: 1 mm/s Deflection: 2 mm Holding time: 5 s</p> 
8.3	Vibration	Appearance shall have no significant mechanical damage.	<p>Oscillation frequency: 10 Hz to 55 Hz to 10 Hz, for approx. 1 min Total amplitude: 1.5 mm Test time: 3 directions perpendicular to each other, 2 h for each direction (6 h in total)</p>
8.4	Solderability	90% or more of the outer electrode shall be covered with new solder seamlessly.	<p>Flux: immersed in ethanol solution [including an activator with a chlorine conversion value of 0.06(wt)%] with a rosin content of 25(wt)% for 5 s to 10 s. Solder: Sn-3.0Ag-0.5Cu solder Pre-heating: 150°C±10°C/60 s to 90 s Solder temperature: 240°C±5°C Immersion time: 3 s±1 s</p>
8.5	Resistance to soldering heat	Appearance: No significant mechanical damage shall be observed. Inductance change rate: within ±5%	<p>Flux: immersed in ethanol solution [including an activator with a chlorine conversion value of 0.06(wt)%] with a rosin content of 25(wt)% for 5 s to 10 s. Solder: Sn-3.0Ag-0.5Cu solder Pre-heating: 150°C±10°C/60 s to 90 s Solder temperature: 270°C±5°C Immersion time: 10 s±1 s Post-treatment: left at a room condition for 24 h±2 h</p>

9. Environmental Performance

The product is soldered on a substrate for test.

No.	Item	Specification	Test method
9.1	Heat resistance	Appearance: No significant mechanical damage shall be observed. Inductance change rate: within ±5% Q change rate: within ±20%	<p>Temperature: 125°C±2°C Test time: 1000 h (+48 h, -0 h) Post-treatment: left at a room condition for 24 h±2 h</p>
9.2	Cold resistance	Appearance: No significant mechanical damage shall be observed. Inductance change rate: within ±5% Q change rate: within ±20%	<p>Temperature: -55°C±2°C Test time: 1000 h (+48 h, -0 h) Post-treatment: left at a room condition for 24 h±2 h</p>
9.3	Humidity	Appearance: No significant mechanical damage shall be observed. Inductance change rate: within ±5% Q change rate: within ±20%	<p>Temperature: 70°C±2°C Humidity: 90% (RH) to 95% (RH) Test time: 1000 h (+48 h, -0 h) Post-treatment: left at a room condition for 24 h±2 h</p>
9.4	Temperature cycle	Appearance: No significant mechanical damage shall be observed. Inductance change rate: within ±5% Q change rate: within ±20%	<p>Single cycle conditions: Step 1: -55°C±2°C/30 min±3 min Step 2: ordinary temperature/10 min to 15 min Step 3: +125°C±2°C/30 min±3 min Step 4: ordinary temperature/10 min to 15 min Number of testing: 10 cycles Post-treatment: left at a room condition for 24 h±2 h</p>

10. Specification of Packaging

10.1 Appearance and dimensions of tape (8 mm width/paper tape)



A	0.75±0.03
B	1.180±0.03
t	0.80 max.

(in mm)

10.2 Taping specifications

Packing quantity (Standard quantity)	10000 pcs/reel
Packing method	The products are placed in embossed cavities of a base tape and sealed by a cover tape.
Feed hole position	The feed holes on the base tape are on the right side when the cover tape is pulled toward the user.
Joint	The base tape and the cover tape are seamless.
Number of missing products	Number of missing products within 0.025% of the number per reel or 1 pc., whichever is greater, and are not continuous. The specified quantity per reel is kept.

10.3 Break down force of tape

Break down force of cover tape	5 N min.
--------------------------------	----------

10.4 Peeling off force of cover tape

Speed of peeling off	300 mm/min
Peeling off force	0.1 N to 0.6 N (The lower limit is for typical value.)



10.5 Dimensions of leader section, trailer section and reel

A vacant section is provided in the leader (start) section and trailer (end) section of the tape for the product. The leader section is further provided with an area consisting only of the cover tape (or top tape). (See the diagram below.)



(in mm)

10.6 Marking for reel

Customer part number, Murata part number, inspection number (*1), RoHS marking (*2), quantity, etc.

<p>*1 Expression of inspection No.:</p> <table style="width: 100%; border-collapse: collapse;"> <tr> <td style="text-align: center; border: 1px solid black;">□□</td> <td style="text-align: center; border: 1px solid black;">○○○○</td> <td style="text-align: center; border: 1px solid black;">◇◇◇</td> </tr> <tr> <td style="text-align: center;">(1)</td> <td style="text-align: center;">(2)</td> <td style="text-align: center;">(3)</td> </tr> </table>	□□	○○○○	◇◇◇	(1)	(2)	(3)	<p>(1) Factory code (2) Date First digit: year/last digit of year Second digit: month/Jan. to Sep.→1 to 9, Oct. to Dec.→O, N, D Third, Fourth digit: day (3) Serial No.</p>
□□	○○○○	◇◇◇					
(1)	(2)	(3)					
<p>*2 Expression of RoHS marking:</p> <table style="width: 100%; border-collapse: collapse;"> <tr> <td style="text-align: center;">ROHS-</td> <td style="text-align: center; border: 1px solid black;">Y</td> <td style="text-align: center; border: 1px solid black;">(△)</td> </tr> <tr> <td></td> <td style="text-align: center;">(1)</td> <td style="text-align: center;">(2)</td> </tr> </table>	ROHS-	Y	(△)		(1)	(2)	<p>(1) RoHS regulation conformity (2) Murata classification number</p>
ROHS-	Y	(△)					
	(1)	(2)					

10.7 Marking on outer box (corrugated box)

Customer name, purchasing order number, customer part number, Murata part number, RoHS marking (*2), quantity, etc.

10.8 Specification of outer box



Dimensions of outer box (mm)			Standard reel quantity in outer box (reel)
W	D	H	
186	186	93	5
* Above outer box size is typical. It depends on a quantity of an order.			

11. ⚠Caution

11.1 Restricted applications

Please contact us before using our products for the applications listed below which require especially high reliability for the prevention of defects which might directly cause damage to the third party's life, body or property.

- | | | | |
|-------------------------------|---|------------------------------|---|
| (1) Aircraft equipment | (2) Aerospace equipment | (3) Undersea equipment | (4) Power plant control equipment |
| (5) Medical equipment | (6) Transportation equipment (vehicles, trains, ships, etc.) | (7) Traffic signal equipment | (8) Disaster/crime prevention equipment |
| (9) Data-processing equipment | (10) Applications of similar complexity and/or reliability requirements to the applications listed in the above | | |

11.2 Precautions on rating

Avoid using in exceeded the rated temperature range, rated voltage, or rated current. Usage when the ratings are exceeded could lead to wire breakage, burning, or other serious fault.

11.3 Inrush current

If an inrush current (or pulse current or rush current) that significantly exceeds the rated current is applied to the product, overheating could occur, resulting in wire breakage, burning, or other serious fault.

11.4 Corrosive gas

Please refrain from use since contact with environments with corrosive gases (sulfur gas [hydrogen sulfide, sulfur dioxide, etc.], chlorine, ammonia, etc.) or oils (cutting oil, silicone oil, etc.) that have come into contact with the previously stated corrosive gas environment will result in deterioration of product quality or an open from deterioration due to corrosion of product electrode, etc. We will not bear any responsibility for use under these environments.

12. Precautions for Use

This product is for use only with reflow soldering. It is designed to be mounted by soldering. If you want to use other mounting method, for example, using a conductive adhesive, please consult us beforehand.

Also, if repeatedly subjected to temperature cycles or other thermal stress, due to the difference in the coefficient of thermal expansion with the mounting substrate, the solder (solder fillet part) in the mounting part may crack.

The occurrence of cracks due to thermal stress is affected by the size of the land where mounted, the solder volume, and the heat dissipation of the mounting substrate. Carefully design it when a large change in ambient temperature is assumed.

12.1 Land dimensions

The following diagram shows the recommended land dimensions for reflow soldering.

The land dimensions are designed in consideration of electrical characteristics and mountability. Use of other land dimensions may preclude achievement of performance. In some cases, it may result in poor solderability, including positional shift. If you use other land pattern, consider it adequately.

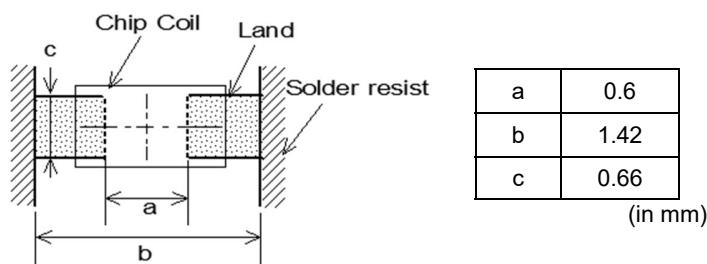

12.2 Flux and solder used

Flux	<ul style="list-style-type: none"> • Use a rosin-based flux that includes an activator with a chlorine conversion value of 0.06(wt)% to 0.1(wt)%. • Do not use a highly acidic flux with a halide content exceeding 0.2(wt)% (chlorine conversion value). • Do not use a water-soluble flux.
Solder	<ul style="list-style-type: none"> • Use Sn-3.0Ag-0.5Cu solder. • Standard thickness of solder paste: 50 μm to 100 μm

If you want to use a flux other than the above, please consult our technical department.

12.3 Soldering conditions (reflow)

- Pre-heating should be in such a way that the temperature difference between solder and product surface is limited to 150°C max.

Cooling into solvent after soldering also should be in such a way that the temperature difference is limited to 100°C max. Insufficient pre-heating may cause cracks on the product, resulting in the deterioration of product quality.

- Standard soldering profile and the limit soldering profile is as follows.

The excessive limit soldering conditions may cause leaching of the electrode and/or resulting in the deterioration of product quality.

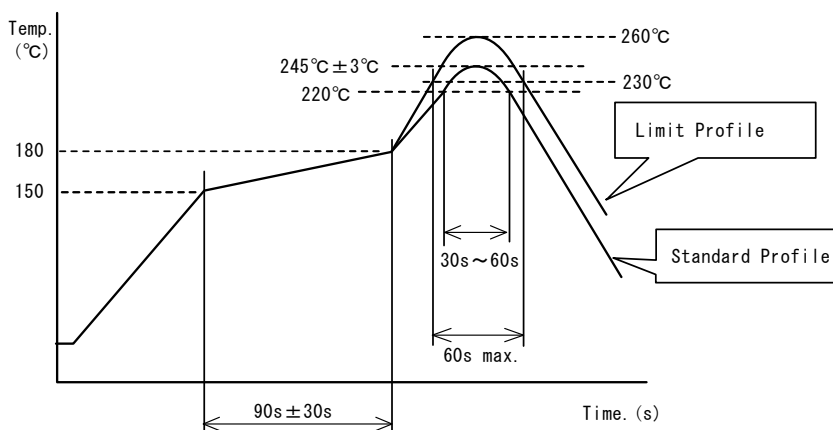

	Standard profile	Limit profile
Pre-heating	150°C to 180°C/90 s±30 s	150°C to 180°C/90 s±30 s
Heating	Above 220°C/30 s to 60 s	Above 230°C/60 s max.
Peak temperature	245°C±3°C	260°C/10 s
Number of reflow cycles	2 times	2 times

12.4 Reworking with soldering iron

Do not perform reworking with a soldering iron on this product.

12.5 Solder volume

Solder shall be used not to increase the volume too much.

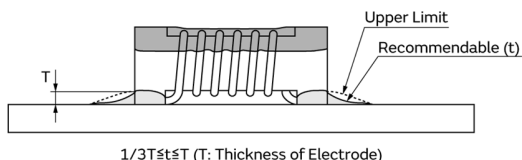

An increased solder volume increases mechanical stress on the product. Exceeding solder volume may cause the failure of mechanical or electrical performance.

12.6 Product's location

The following shall be considered when designing and laying out PCBs.

(1) PCB shall be designed so that products are not subject to mechanical stress due to warping the board.

[Products direction]

Products shall be located in the sideways direction (length: $a < b$) to the mechanical stress.

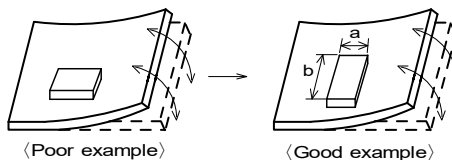

(2) Components location on PCB separation

It is effective to implement the following measures, to reduce stress in separating the board.

It is best to implement all of the following three measures; however, implement as many measures as possible to reduce stress.

Contents of measures	Stress level
(1) Turn the mounting direction of the component parallel to the board separation surface.	$A > D^*1$
(2) Add slits in the board separation part.	$A > B$
(3) Keep the mounting position of the component away from the board separation surface.	$A > C$
*1 $A > D$ is valid when stress is added vertically to the perforation as with hand separation. If a cutting disc is used, stress will be diagonal to the PCB, therefore $A > D$ is invalid.	

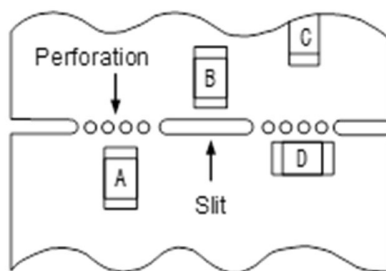

(3) Mounting components near screw holes

When a component is mounted near a screw hole, it may be affected by the board deflection that occurs during the tightening of the screw.

Mount the component in a position as far away from the screw holes as possible.

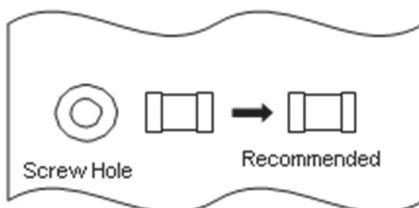

12.7 Handling of substrate

After mounting products on a substrate, do not apply any stress to the product caused by bending or twisting to the substrate when cropping the substrate, inserting and removing a connector from the substrate or tightening screw to the substrate. Excessive mechanical stress may cause cracking in the product.



Bending

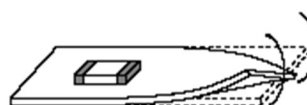

Twisting

12.8 Cleaning

The product shall be cleaned under the following conditions.

- (1) The cleaning temperature shall be 60°C max. If isopropyl alcohol (IPA) is used, the cleaning temperature shall be 40°C max.
- (2) Perform ultrasonic cleaning under the following conditions. Exercise caution to prevent resonance phenomenon in mounted products and the PCB.

Item	Requirement
Power	20 W/L max.
Time	5 min max.
Frequency	28 kHz to 40 kHz

- (3) Cleaner

Alcohol-based cleaner: IPA
 Aqueous agent: PINE ALPHA ST-100S

- (4) There shall be no residual flux or residual cleaner. When using aqueous agent, rinse the product with deionized water adequately and completely dry it so that no cleaner is left.

* For other cleaning, consult our technical department.

12.9 Storage and transportation

Storage period	Use the product within 12 months after delivery. If you do not use the product for more than 12 months, check solderability before using it.
Storage conditions	<ul style="list-style-type: none"> • The products shall be stored in a room not subject to rapid changes in temperature and humidity. The recommended temperature range is -10°C to +40°C. The recommended relative humidity range is 15% to 85%. • Keeping the product in corrosive gases, such as sulfur, chlorine gas or acid, oxidizes the electrode, resulting in poor solderability or corrosion of the coil wire of the product. • Do not keep products in bulk packaging. Doing so may cause collision between the products or between the products and other products, resulting in core chipping or wire breakage. • Do not place the products directly on the floor; they should be placed on a palette so that they are not affected by humidity or dust. • Avoid keeping the products in a place exposed to direct sunlight, heat or vibration.
Transportation	Excessive vibration and impact reduces the reliability of the products. Exercise caution when handling the products.

12.10 Resin coating

The inductance value may change due to high cure-stress of resin to be used for coating/molding products.

A wire breakage issue may occur by mechanical stress caused by the resin, amount/cured shape of resin, or operating condition etc. Some resin contains some impurities or chloride possible to generate chlorine by hydrolysis under some operating condition may cause corrosion of wire of coil, leading to wire breakage.

So, please pay your careful attention when you select resin in case of coating/molding the products with the resin.

Prior to use the coating resin, please make sure no reliability issue is observed by evaluating products mounted on your board.

12.11 Handling of product

- Sharp material such as a pair of tweezers or other material such as bristles of cleaning brush, shall not be touched to the winding portion to prevent the breaking of wire.
- Mechanical shock should not be applied to the products mounted on the board to prevent the breaking of the core.

12.12 Handling with mounting equipment

- With some types of mounting equipment, a support pin pushes up the product from the bottom of the base (paper) tape when the product is sucked with the pick-up nozzle.
When using this type of equipment, detach the support pin to prevent the breaking of wire on the product.
- In some cases, the laser recognition function of the mounting equipment may not recognize this product correctly.
Please contact us when using laser recognition. (There is no problem with the permeation and reflection type.)

13. Note

- (1) Please make sure that your product has been evaluated in view of your specifications with our product being mounted to your product.
- (2) You are requested not to use our product deviating from the reference specifications.
- (3) The contents of this reference specification are subject to change without advance notice. Please approve our product specifications or transact the approval sheet for product specifications before ordering.

14. Appendix

Electrical performance: Measuring method for inductance/Q (Q measurement is applicable only when the Q value is included in the rating table.)
Perform measurement using the method described below. (Perform correction for the error deriving from the measuring terminal.)

- (1) Residual elements and stray elements of the measuring terminal can be expressed by the F parameter for the 2-pole terminal as shown in the figure below.



- (2) The product's impedance value (Z_x) and measured impedance value (Z_m) can be expressed as shown below, by using the respective current and voltage for input/output.

$$Z_m = \frac{V_1}{I_1} \quad Z_x = \frac{V_2}{I_2}$$

- (3) Thus, the relationship between the product's impedance value (Z_x) and measured impedance value (Z_m) is as follows.



$Z_x = \alpha \frac{Z_m - \beta}{1 - Z_m \Gamma}$	<p>Here,</p> <p>$\alpha = D/A = 1$</p> <p>$\beta = B/D = Z_{sm} - (1 - Y_{om} Z_{sm}) Z_{ss}$</p> <p>$\Gamma = C/A = Y_{om}$</p> <p>$Z_{sm}$: measured impedance of short chip</p> <p>Z_{ss}: residual impedance of short chip (0.556 nH)</p> <p>Y_{om}: measured admittance when measuring terminal is open</p>
---	--

- (4) Calculate inductance L_x and Q_x using the equations shown below.

$L_x = \frac{\text{Im}(Z_x)}{2\pi f}$	<p>L_x: inductance of chip coil</p> <p>Q_x: Q of chip coil</p>
$Q_x = \frac{\text{Im}(Z_x)}{\text{Re}(Z_x)}$	<p>f: measuring frequency</p>

Looking for pricing, stock, or lifecycle information?

Click below to explore more details on WIN SOURCE:

-  [View LQW15AN1N7C80D on WIN SOURCE](#)
-  [Murata Electronics North America Information](#)

Optimize Your Supply Chain with WIN SOURCE Solutions

-  Global Sourcing Solution
-  Obsolete Management
-  Cost Control Management
-  Shortage Management
-  Alternative Solution
-  Excess Inventory Management