

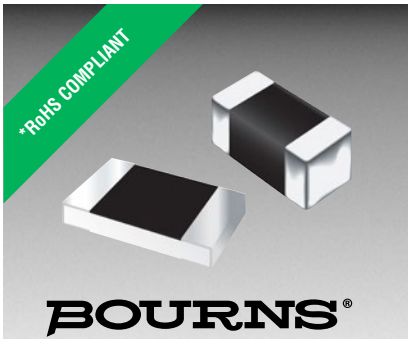

**THE DATASHEET OF
CG0603MLC-05LE**





Features

- RoHS compliant*
- ESD protection >25 kV
- Low capacitance <0.5 pF
- Low leakage current <50 nA

Applications

- HDMI 1.4
- Digital Visual Interface (DVI)
- USB 3.0 / USB OTG
- Memory protection
- SIM card ports

ChipGuard® MLC Series - ESD Protectors

General Information

The ChipGuard® MLC Series has been specifically designed to protect sensitive electronic components from electrostatic discharge damage. The MLC family has been designed to protect equipment to IEC61000-4-2, Level 4 (± 8 kV Contact / ± 15 kV Air Discharge) ESD specifications targeted for high speed USB 3.0/USB OTG, HDMI 1.4, DVI or IEEE1394 applications.

The ChipGuard® MLC Series has been manufactured to provide low 0.5 pF capacitance and leakage currents less than 5 nA with excellent clamp qualities, making the family almost transparent under normal working conditions.

Device Symbol



Electrical Characteristics @ 25 °C (unless otherwise noted)

Parameter	Symbol	CG0402MLC-								Unit
		3.3LG	05LG	12LG	24LG	3.3LGA	05LGA	12LGA	24LGA	
Typical Continuous Operating Voltage	V_{DC}	3.3	5	12	24	3.3	5	12	24	V
Typical Clamping Voltage (Note 1)	V_C	25								V
Maximum Capacitance @ 1 VRMS 1 MHz	C_O	0.5								pF
Maximum Leakage Current @ Max. VDC	I_L	5								nA
Typical Trigger Voltage (Note 2)	V_T	250								V
Maximum Response Time	R_T	1								ns
ESD Protection: Per IEC 61000-4-2 Level 4 Min. Contact Discharge Min. Air Discharge Min. Air Discharge		± 8 ± 15 (Note 3) ± 25								kV kV kV
Operating Temperature	T_{OPR}	-40 to +85				-40 to +125				°C
Storage Temperature	T_{STG}	-55 to +150								°C

Parameter	Symbol	CG0603MLC-								Unit
		3.3LE	05LE	12LE	24LE	3.3LEA	05LEA	12LEA	24LEA	
Typical Continuous Operating Voltage	V_{DC}	3.3	5	12	24	3.3	5	12	24	V
Typical Clamping Voltage (Note 1)	V_C	25	25	25						V
Maximum Capacitance @ 1 VRMS 1 MHz	C_O	0.5								pF
Maximum Leakage Current @ Max. VDC	I_L	5	5	5						nA
Typical Trigger Voltage (Note 2)	V_T	250	250	250						V
Maximum Response Time	R_T	1								ns
ESD Protection: Per IEC 61000-4-2 Level 4 Min. Contact Discharge Min. Air Discharge Min. Air Discharge		± 8 ± 15 (Note 3) ± 25								kV kV kV
Operating Temperature	T_{OPR}	-40 to +85				-40 to +125				°C
Storage Temperature	T_{STG}	-55 to +150								°C

- Notes: 1. Per IEC 61000-4-2, Level 4 8 kV Contact Discharge. Measurement 30 ns after initiation of pulse.
 2. Per IEC 61000-4-2, Level 4 8 kV Contact Discharge. Measurement at maximum pulse voltage.
 3. IEC 61000-4-2 ESD Performance will meet minimum 1000 reps without degradation in performance.

*RoHS Directive 2002/95/EC Jan. 27, 2003 including annex and RoHS Recast 2011/65/EU June 8, 2011.
 Specifications are subject to change without notice.

The device characteristics and parameters in this data sheet can and do vary in different applications and actual device performance may vary over time.
 Users should verify actual device performance in their specific applications.

Product Dimensions

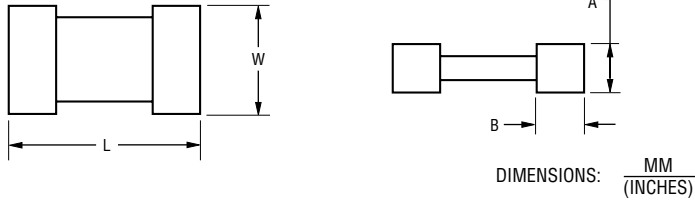

Dimension	CG0402 Series	CG0603 Series
L	$\frac{1.00 \pm 0.15}{(0.04 \pm 0.006)}$	$\frac{1.60 \pm 0.20}{(0.064 \pm 0.008)}$
W	$\frac{0.50 \pm 0.10}{(0.02 \pm 0.004)}$	$\frac{0.80 \pm 0.20}{(0.032 \pm 0.008)}$
A	$\frac{0.36 \pm 0.05}{(0.014 \pm 0.002)}$	$\frac{0.45 \pm 0.10}{(0.018 \pm 0.004)}$
B	$\frac{0.25 \pm 0.15}{(0.10 \pm 0.006)}$	$\frac{0.30 \pm 0.20}{(0.012 \pm 0.008)}$

Recommended Pad Layout

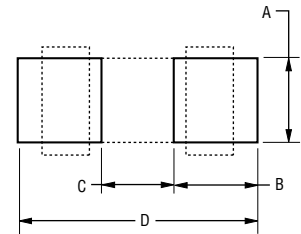

Dim.	CG0402 Series	CG0603 Series
A	$\frac{0.51}{(0.020)}$	$\frac{0.76}{(0.030)}$
B	$\frac{0.61}{(0.024)}$	$\frac{1.02}{(0.040)}$
C	$\frac{0.51}{(0.020)}$	$\frac{0.50}{(0.020)}$
D	$\frac{1.70}{(0.067)}$	$\frac{2.54}{(0.100)}$

Solder Reflow Recommendations

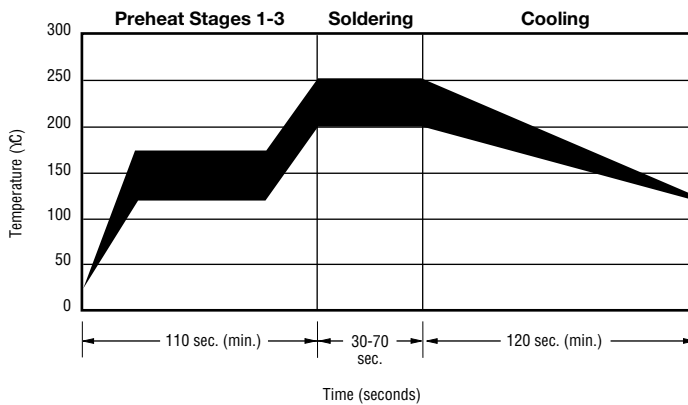

A	Stage 1 Preheat	Ambient to Preheating Temperature	30 s to 60 s
B	Stage 2 Preheat	140 °C to 160 °C	60 s to 120 s
C	Stage 3 Preheat	Preheat to 200 °C	20 s to 40 s
D	Main Heating	200 °C 210 °C 220 °C 230 °C 240 °C 250 °C to 255 °C	60 s to 70 s 55 s to 65 s 50 s to 60 s 40 s to 50 s 30 s to 40 s 5 s
E	Cooling	200 °C to 100 °C	1 °C/s to 4 °C/s

- This product can be damaged by rapid heating, cooling or localized heating.
- Heat shocks should be avoided. Preheating and gradual cooling recommended.
- Excessive solder can damage the device. Print solder thickness of 150 to 200 um recommended.
- Solder gun tip temperature should be kept below 280 °C and should not touch the device directly. Contact should be less than 3 seconds. A solder gun under 30 watts is recommended.

Packaging Dimensions

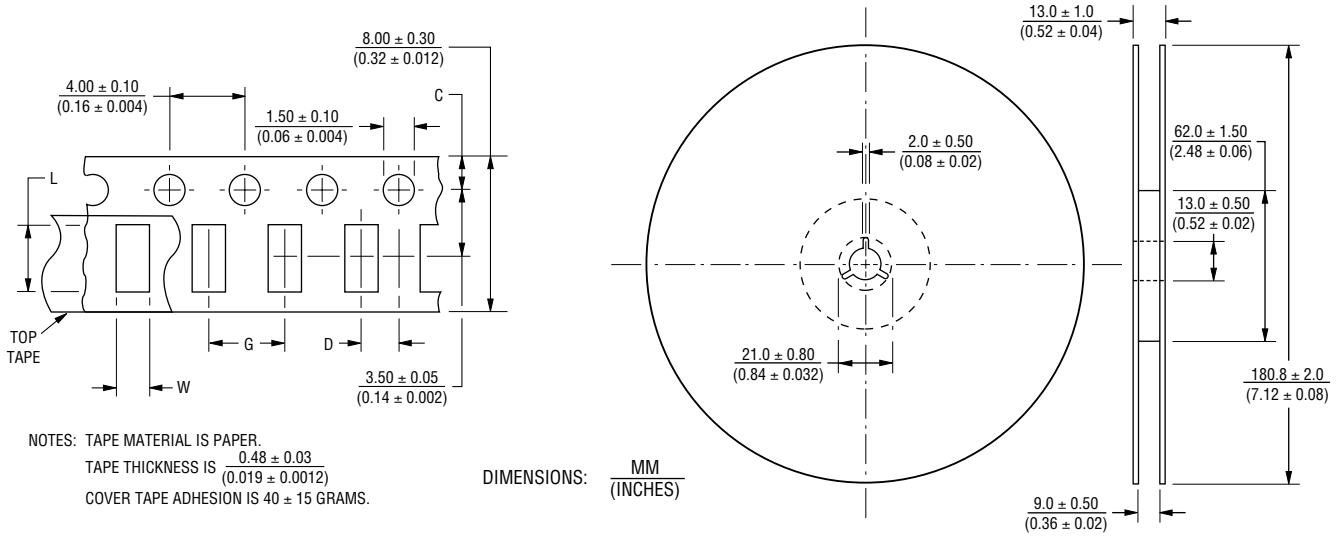

Dimension	CG0402 Series	CG0603 Series
C	$\frac{1.75 \pm 0.05}{(0.04 \pm 0.002)}$	$\frac{1.75 \pm 0.10}{(0.04 \pm 0.004)}$
D	$\frac{2.00 \pm 0.02}{(0.08 \pm 0.0008)}$	$\frac{2.00 \pm 0.05}{(0.08 \pm 0.002)}$
L	$\frac{1.12 \pm 0.03}{(0.045 \pm 0.0012)}$	$\frac{1.80 \pm 0.20}{(0.072 \pm 0.008)}$
W	$\frac{0.62 \pm 0.03}{(0.025 \pm 0.0012)}$	$\frac{0.90 \pm 0.20}{(0.036 \pm 0.008)}$
G	$\frac{2.0 \pm 0.05}{(0.08 \pm 0.002)}$	$\frac{4.0 \pm 0.05}{(0.16 \pm 0.002)}$

How to Order

CG 0n0n MLC - n.n x x x

ChipGuard®
 Product Designator
 Package Option
 0402 = 0402 Package
 0603 = 0603 Package
 Multilayer Series Designator
 Operating Voltage**
 3.3 = 3.3 V
 05 = 5 V
 12 = 12 V
 24 = 24 V
 Low Leakage Current Option
 L = Low Leakage Current
 Blank = Standard Product
 Tape & Reel Packaging
 E = 5,000 pcs. per reel (0603 Package)
 G = 10,000 pcs. per reel (0402 Package)
 Operating Temperature Option
 A = Higher +125 °C Operating Temperature
 Blank = Standard Product

** Only models lower than 10 volts require decimal point.

BOURNS®

Asia-Pacific: Tel: +886-2 2562-4117 • Email: asiacus@bourns.com



EMEA: Tel: +36 88 520 390 • Email: eurocus@bourns.com

The Americas: Tel: +1-951 781-5500 • Email: americus@bourns.com

www.bourns.com

Looking for pricing, stock, or lifecycle information?

Click below to explore more details on WIN SOURCE:

-  [View CG0603MLC-05LE on WIN SOURCE](#)
-  [Bourns Inc. Information](#)

Optimize Your Supply Chain with WIN SOURCE Solutions

-  Global Sourcing Solution
-  Obsolete Management
-  Cost Control Management
-  Shortage Management
-  Alternative Solution
-  Excess Inventory Management